

# elektor

74  
June 1981  
U.K. 60p  
U.S.A. \$2

up-to-date electronics for lab and leisure

## 70 cm transverter

use a 2 metre transceiver  
on the 70 cm band

## scrambler

scrambling and  
unscrambling speech

## storage 'scope

a useful extension for  
the logic analyser

*Minder Song*



selektor .....	6-01
farewell and welcome .....	6-05
scrambler .....	6-06
A 'hot' line may be useful for passing personal information to a friend or business associate. The circuit described in this article will garble the speakers voice to the extent that it will be entirely unintelligible to any unwanted listener.	
<b>the Junior reaches maturity</b> .....	6-10
This is the final article on a very important stage in the development of the Junior Computer. All constructional details for the extension boards are covered together with modifications to the main board and power supply.	
coming soon .....	6-17
<b>water level indicator</b> .....	6-18
A couple of ordinary logic gates and a row of LEDs can produce an amazing amount of flower power.	
<b>transverter for the 70 cm band</b> .....	6-20
For many radio amateurs the 70 cm band is totally unexplored territory. This article provides an answer to this situation by inviting readers to construct their own transverter. Many of the inductors are etched on the printed circuit board itself.	
<b>map reading by computer</b> .....	6-29
This article describes a small sensor which enables distances on a map to be measured with the help of your computer.	
<b>storage scope</b> .....	6-34
Sometimes it is useful to be able to 'freeze' very fast or very slow signals on an oscilloscope screen. For this the oscilloscope will have to be provided with a memory. The solution offered in this article is to use a standard oscilloscope and combine it with the Elektor logic analyser.	
<b>to all Elektor readers</b> .....	6-38
... who missed their chance to get rich quick.	
<b>digital audio</b> .....	6-39
Audio experts have found a new field in which to exercise their powers of conviction. This article gives readers an indication of the state of the argument in digital audio at the moment.	
<b>roger bleep</b> .....	6-42
The roger bleep is getting to be more popular with transceiver users. The circuit featured in this article gives a gong like sound adding a personal note to the end of transmissions.	
<b>talk to computers</b> .....	6-44
The first article on this subject described various methods of teaching computers to talk. However, conversations would be rather one-sided unless the computer is also able to 'listen' and take note of the human point of view.	
<b>market</b> .....	6-48

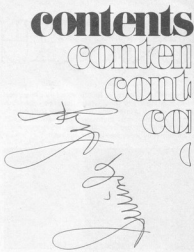

**EDITOR:**

P. Holmes

**UK EDITORIAL STAFF**

T. Day E. Rogans  
P. Williams

**TECHNICAL EDITORIAL STAFF**

J. Barendrecht  
G.H.K. Dam  
E. Krempelsauer  
G. Nachbar  
A. Nachtmann  
K.S.M. Walraven



# selektor 2010101

## Enhanced Teletext Systems

Since its introduction in 1976 by the British broadcasters, BBC and IBA, teletext went through a period of rapid development. Other countries, interested in the possibilities of this system, started experimental broadcasts soon after. Currently, W-Germany, Sweden and the Netherlands have teletext systems based on the British' Broadcast Teletext Specification', a data broadcasting standard published in 1976, aimed at providing a reliable and high-quality service. France developed its own system for teletext transmission, designated Didon.

Broadcasting authorities are not behind in realising that the current teletext systems could be improved. Over the past years, several shortcomings of the present teletext systems have been mentioned. Firstly, access time, that is the time between selecting a teletext page at a receiver and the first complete reception of that page, is slow. Secondly, on a European level, the original set of 96 alphanumeric characters does not suit the requirements of the languages used. Thirdly, a better resolution, enabling transmission of pages as shown in picture 1, would make teletext considerably more attractive to many television owners, and enhance possibilities for information transmission.

One of the pioneers of teletext development, the engineering division of the BBC's research department, is on the forefront of enhanced teletext research also. John Chambers, head of the special projects section of the department, was given the 'outstanding paper of 1980' award at the IEEE's Chicago conference last year. The paper, called 'Enhanced UK Teletext Moves Towards Still Pictures', outlines different methods for improving the teletext system as currently used in the UK and other countries.

Before looking closer at the technicalities of Chambers' proposals, a quick review of the way teletext works seems convenient, as the BBC plans are modifications of the present system.

Teletext was designed for displaying data on the screens of domestic television receivers, transmitted via the television signal. Teletext offers considerable advantages over regular television broadcasts, as each page can be viewed as often and as long as required. There is an essential difference between the teletext signal and the television image information on a channel. If letters are displayed on a conventional

television picture, they are also present in the studio. The letters, like images or persons, are scanned by a camera and the information is transmitted in an analogue mode. With teletext on the other hand, a digital code is included in the television signal. A decoder recognises the 0s and 1s in the signal and generates the corresponding characters on the tv screen. The digital code used in the UK system employs one byte (8 bits) for each character or graphical symbol. The actual information is conveyed by 7 bits, 1 bit is used for an odd parity check. This is a means of error detection: the number of 1s in one byte must always be odd.

Beside characters and graphic symbols, control characters must be transmitted to the decoder. These include information on the display mode, such as colour/background colour, normal/double height, alphanumeric/graphic

mode etc. Table 1 gives the specific 7 bit codes for control and alphanumeric characters and graphic symbols. Bits b1...b7 contain the actual information, while bit 8 is made odd or even to satisfy the odd parity check. To transmit e.g. lower case 'g' in green, two bytes are needed, one control character and one for identifying the 'g':  
01000000      11001110  
alphanumeric green      'g'

Several methods have been considered for transmitting the extra teletext signals containing the digital code on a television channel. One possibility is using a subcarrier within the video bandwidth similar to the chrominance (colour) information in normal television broadcasts.

The UK system, however, employs the unused lines in the field-blanking interval which is included in the television channel. This interval allows the electron beam of the television tube to

Table 1. Existing teletext character set (odd parity).

Bits	b7 b6 b5 b4 b3 b2 b1							0 0		0 0 <sub>1</sub>		0 0 <sub>0</sub>		0 1 <sub>1</sub>		1 0 <sub>0</sub>		1 0 <sub>1</sub>		1 1 <sub>0</sub>		1 1 <sub>1</sub>	
	0	1	0	1	0	1	0	00	01	02	02a	03	03a	04	05	06	06a	07	07a				
0 0 0 0 0	0	0	0	0	0	0	0	NU <sup>1</sup>	DLE <sup>2</sup>			0		@	P			p					
0 0 0 1 1	0	0	1	1				Alpha <sup>3</sup> Red	Mosaic Red			1		A	Q	a		q					
0 0 1 0 2	0	0	1	0				Alpha <sup>3</sup> Green	Mosaic Green			2		B	R	b		r					
0 0 1 1 3	0	0	1	1				Alpha <sup>3</sup> Yellow	Mosaic Yellow			3		C	S	c		s					
0 1 0 0 4	0	1	0	0				Alpha <sup>3</sup> Blue	Mosaic Blue			4		D	T	d		t					
0 1 0 1 5	0	1	0	1				Alpha <sup>3</sup> Magenta	Mosaic Magenta			5		E	U	e		u					
0 1 1 0 6	0	1	1	0				Alpha <sup>3</sup> Cyan	Mosaic Cyan			6		F	V	f		v					
0 1 1 1 7	0	1	1	1				Alpha <sup>3</sup> White	Mosaic White			7		G	W	g		w					
1 0 0 0 8	1	0	0	0				Flash	Conceal Display			8		H	X	h		x					
1 0 0 1 9	1	0	0	1				Steady <sup>4</sup>	Contiguous Mosaic, Stop Underline			9		I	Y	i		y					
1 0 1 0 10	1	0	1	0				End Box	Separated Mosaic, Start Underline			10		J	Z	j		z					
1 0 1 1 11	1	0	1	1				Start Box	ESC <sup>5</sup>			11		K		k							
1 1 0 0 12	1	1	0	0				Normal Height	Block Background			12		L		l							
1 1 0 1 13	1	1	0	1				Double Height	New Background			13		M		m							
1 1 1 0 14	1	1	1	0				SO <sup>6</sup>	Hold Mosaic			14		N		n							
1 1 1 1 15	1	1	1	1				SI <sup>7</sup>	Release Mosaic			15		O		o							

<sup>1</sup> These control characters are reserved for future use. <sup>2</sup> These control characters are presumed before each row begins. <sup>3</sup> Also 'Restore Format'. <sup>4</sup> b<sub>7</sub> is set to give an odd number of 1's in the eight bit character code. <sup>5</sup> Codes may be referred to by their column and row e.g. O2/8 refers to %.

Character rectangle  
Black represents display colour  
White represents background

fly back from bottom-right to top-left before each active field begins. During this period, 25 lines remain unused, but only maximally 15 lines are actually needed for field fly-back. This leaves in principle 10 lines to be used for containing the teletext signal, the current system uses two lines. The teletext bit code is transmitted at a rate of 6.9375 M bit/s during these two lines which are called data lines. In the UK, lines 17 and 18 (330 and 331) are being used, in the Netherlands lines 15 and 16 (328 and 329).

Some simple calculations reveal some of the limitations of the present system. During one line, 52 microseconds are available for data transmission. This implies that  $6.9375 \text{ (bit rate)} \times 10^6 \times 52 \text{ (microseconds)} \times 10^{-6} = 360 \text{ bits 'fit'}$  on a line: 45 bytes. Since 5 bytes are used for synchronisation and page and row indication, 40 bytes maximally remain for characters. Because the digital

1 P666 CEEFAX - experiment

ENHANCED TELETEXT SYSTEMS

An Enhanced TELETEXT system will allow pages to include

with a quality limited only by the display device.



Table 2. Extended character set (even parity).

b <sub>8</sub>	b <sub>7</sub> b <sub>6</sub> b <sub>5</sub> b <sub>4</sub>				b <sub>3</sub> b <sub>2</sub> b <sub>1</sub> b <sub>0</sub>																	
	b <sub>11</sub>	b <sub>10</sub>	b <sub>9</sub>	b <sub>8</sub>	EO	E1	E2	E3	E4	E5	E6	E7	EO	E1	E2	E3	E4	E5	E6	E7		
0	0	0	0	0	⓪	Ⓛ	Ⓜ	Ⓝ	Ⓞ	Ⓟ	Ⓠ	Ⓡ	Ⓢ	Ⓣ	Ⓤ	Ⓥ	Ⓦ	Ⓧ	Ⓨ	Ⓩ	ⓐ	
0	0	0	1	1		!	À	á	â	ã	ä	å	Ä	Å	Ÿ							
0	0	1	0	2	£	²	À	á	â	ã	ä	å	Ä	Å	Ÿ							
0	0	1	1	3	£	²	À	á	â	ã	ä	å	Ä	Å	Ÿ							
0	1	0	0	4	⊗	⊘	⊙	⊚	⊛	⊜	⊝	⊞	⊟	⊠	⊡	⊢	⊣	⊤	⊥	⊦	⊧	
0	1	0	1	5	⊗	⊘	⊙	⊚	⊛	⊜	⊝	⊞	⊟	⊠	⊡	⊢	⊣	⊤	⊥	⊦	⊧	
0	1	1	0	6	⊗	⊘	⊙	⊚	⊛	⊜	⊝	⊞	⊟	⊠	⊡	⊢	⊣	⊤	⊥	⊦	⊧	
0	1	1	1	7	⊗	⊘	⊙	⊚	⊛	⊜	⊝	⊞	⊟	⊠	⊡	⊢	⊣	⊤	⊥	⊦	⊧	
1	0	0	0	8	Σ	∏	∑	∏	∑	∏	∑	∏	∑	∏	∑	∏	∑	∏	∑	∏	∑	
1	0	0	1	9	∑	∏	∑	∏	∑	∏	∑	∏	∑	∏	∑	∏	∑	∏	∑	∏	∑	
1	0	1	0	10	∑	∏	∑	∏	∑	∏	∑	∏	∑	∏	∑	∏	∑	∏	∑	∏	∑	
1	0	1	1	11	∑	∏	∑	∏	∑	∏	∑	∏	∑	∏	∑	∏	∑	∏	∑	∏	∑	
1	1	0	0	12	∑	∏	∑	∏	∑	∏	∑	∏	∑	∏	∑	∏	∑	∏	∑	∏	∑	
1	1	0	1	13	∑	∏	∑	∏	∑	∏	∑	∏	∑	∏	∑	∏	∑	∏	∑	∏	∑	
1	1	1	0	14	∑	∏	∑	∏	∑	∏	∑	∏	∑	∏	∑	∏	∑	∏	∑	∏	∑	
1	1	1	1	15	∑	∏	∑	∏	∑	∏	∑	∏	∑	∏	∑	∏	∑	∏	∑	∏	∑	

THE CHARACTERS OF THE EVEN-PARITY MOSAIC SET ARE TO BE DEFINED. NUMERALS 0 TO 9, POSSIBLY WITH 'DISTANCED' CODES, MAY BE INCLUDED. THE SET OF 48 CHARACTERS SUCH AS

MAY BE INCLUDED, TOGETHER WITH LINE-DRAWING ELEMENTS SUCH AS

code of one data line is rigidly linked with the position of the characters and symbols on a page row, 40 is the maximum number of characters on a row. The maximum number of rows is determined by the number of lines on a television screen capable of displaying information.

The teletext decoder is based on a 'fixed format' system. It contains a Read Only Memory (ROM) which stores all the patterns of the characters and symbols in a 5 x 9 point matrix. Each address in the page display memory is assigned a character site on the page. The 1 byte code determines if and which character or symbol appears on that site. With a 5 x 9 matrix, and at least one line to separate the rows, one row occupies 10 lines. Since 240 lines are used for teletext pages, the maximum number of rows is  $240 : 10 = 24$ . Each page can contain  $24 \times 40 = 960$  characters.

The pages of a teletext service (around 100 per BBC channel) are transmitted cyclically, e.g. 1-2-3... 99-100-1-2 etc. When a certain page is required, a counter in the decoder compares the page number of the transmitted pages with the required page. If the two numbers correspond, the relevant information code is captured and stored in the page display memory, and then displayed on the screen.

A field blanking occurs every 0.02 seconds — 25 complete pictures per second — so the transmission of 24 rows (1 page) requires  $24 \text{ (rows)} : 2 \text{ (data lines per field blanking)} \times 0.02 = 0.24 \text{ s}$ . In

\* b<sub>8</sub> is set to give an even number of 1's in the eight bit character code.

⓪ These characters have restricted use.

Ⓛ If additional characters are required it is recommended that they be substituted in these positions.

selektor  
2616101



the case of a 100 page service, maximum access time is 24 s, which can be considered as inconveniently long.

We now come to the improvements under study by the BBC team. Firstly there's the problem of access time. Chambers proposes to increase the capacity of the page display memory in the decoder, so that several pages can be captured and stored for ready access while a page is being viewed. This would eliminate the need to wait for a certain page until it appears in the transmission cycle. Since the UK system is already capable, technically, of offering over 2.5 million pages, using existing keyboards and decoders, access times can theoretically amount to almost one week without this facility. The main problem of a larger decoder memory, however, is the question: which pages should be stored? Chambers offers two solutions in his paper. One is to give the user the facility to preprogram a popular selection into the decoder via a non-volatile memory. When the set is switched on, the preferred set of pages is captured as early as possible, ready for viewing. One page can be read while the next few, depending on the capacity of the memory, are being captured.

Another technique involves so called 'linked pages'. The teletext is structured like a tree: while any page is being read, up to six related pages are captured. When a choice is made, this new page in its turn also has a number of related pages. With sufficiently large memories available - 64 k bytes can store around 65 pages - this system obviously makes great demands on the organisation of the teletext editing. But Chambers says that substantial memory price reductions will be necessary before these decoders take off commercially.

The character set of the present system also accounts for limitations. Using the 7 bit code, a total of 96 display characters is available. But a survey of the European Broadcasting Union revealed that around 220 characters will be

# selektor

needed if a European standard is to be established, due to the difference between the various languages.

In Chambers' proposal it is assumed that eight bit codes will be used, giving  $2^8 = 256$  possible characters. Of these, 32 will still be used for control characters, but a total of 244 display characters will be available. According to Chambers, this total is similar to the requirement for the languages using the Latin alphabet, and allows for languages to be mixed within a page. Table 2 shows the extended character set, this is now used in experiments at the BBC research department.

By using an eight bit code, the graphical symbol repertoire can be more than doubled, some of the characters that could be used are also indicated in table 2. Chambers claims that these mosaic patterns add greatly to the capabilities of the system. One major implication of using the full byte for character information is that the odd parity check - preventing generation of characters with 1, 3, 5 or 7 errors in the code byte - will have to be dropped. But the report says that in the vast majority of homes in the UK a properly functioning teletext installation suffers no errors at all on most days. If necessary, other error detection methods can be used, the information for which can be contained in rows 26 or 27, which do not appear on the screen. If the eight bit standard is internationally accepted, existing decoders will be outmoded. Chambers proposes to employ a 'fall back' system. Both sets of information, seven and eight bit code bytes, are transmitted, but only the decoders capable

of responding to the new characters will recognise the corresponding code.

Improving the picture resolution is undoubtedly technically the most complex problem. The jagged edges of a conventional teletext page are, as explained earlier, due to the fact that the screen is divided into 960 5 x 9 matrices, representing the alphanumeric characters. The graphic symbols, columns 02a, 03a, 06a and 07a in table 1, are based on the division of one of the 960 character sites into 6 cells. This explains that a teletext image has a maximum resolution of  $960 \times 6 = 5760$  squares/page. Although the extended graphic symbol set proposed by Chambers enhances the opportunities for an attractive page greatly, it also uses 5760 squares.

The only way to achieve a better resolution consists of increasing the number of addressable areas on the screen. This obviously makes the coding more complex, while more complicated decoders will be necessary. To store one teletext page, around 1k byte of memory is necessary, but 1M byte is required to hold a still television picture. The new system can be provided for the transmission of a sequence of still colour television pictures whose quality is limited only by the display device. Chambers suggests a method which is based on a grid composed of more than 250,000 picture elements (picture 2 and 3). Of the 576 horizontal lines, 512 are used. Per line, around 624 picture elements can be 'fitted in', this is 12 elements per microsecond of active line. This system can display one page partly in the conventional teletext format and partly in the high definition mode. According to Chambers however, any big advances in this area are some years away and would depend on corresponding advances in technology and memory price reduction.

The BBC team expects to have a pair of versatile demonstration and experimental units for the enhanced system completed before June. The next scheduled



Example of mosaic mode resolution



Example of picture-element resolution

presentations on this subject are a Royal Television Society meeting in London on 26th May and the IEEE Chicago Spring Conference on 4th June. But work on these enhanced teletext systems is steadily progressing, and the BBC expects to make additions to its teletext transmissions very soon. It might well be that in future, current teletext systems look as simple to us, as an abacus looks to users of programmable calculators.

#### References:

1. *BBC Research Report RD 1980/4, 'Enhanced UK Teletext Moves Towards Still Pictures', J.P. Chambers, M.A., M.I.E.E.*
2. *Broadcast Teletext Specification BBC/IBA/BREMA, September 1976.*

# selektor

## Extracting solar energy from vegetable matter

There is no shortage of energy on Earth, only a predicted shortage of fossil fuels. Yet, in any week of the year, the amount of sunlight falling on the Earth's surface has the energy equivalent of all the fossil fuel reserves known to man and — if it could be converted — the sunlight reaching an area of about 500 000 km<sup>2</sup> within the tropics would be enough to satisfy all the energy demands of mankind. That alone makes the search for methods of solar conversion crucial for it is evident that, given the appropriate technologies, an unending supply of energy is available for the taking.

There are, however, two major problems. The first is that, unlike present conventional energy sources, sunlight is diffuse: the second is that to replace fossil fuels (themselves the stored energy of former sunlight on Earth) the captured solar energy needs to be converted into a form which can itself be stored. This problem was solved by plants hundreds of millions of years ago when the process of photosynthesis emerged to transform the evolution of our planet.

#### Natural Replenishment

Photosynthesis in Nature depends on the activity of the chlorophyll molecule, working within the chloroplasts of plants, which strongly absorbs the visible and near infra-red parts of the spectrum of sunlight and uses the energy to combine water and carbon

dioxide from the atmosphere to create complicated organic molecules such as sugars. These provide the primary store of chemical energy on which all life is based.

No less important, when the sugars are burned with oxygen in the metabolic processes of living things, water and carbon dioxide are returned to the atmosphere for re-use, thus creating a closed and elegant non-polluting energy cycle. The question facing scientists is whether they can use, understand and modify this cycle so that it substitutes for current and very crude once-through energy systems.

In a world complicated by existing industries and by conflicts over resources we seldom have time to stand back and contemplate the real basis and the real driving force of life. Yet it is these tiny chloroplasts which actually make the world go round. It is their activity in green plants and algae which recycles all the carbon dioxide in the atmosphere once every 300 years or so, and all the oxygen about once every 2000 years, continuously replenishing the natural stockpile of stored solar energy in plant structures. This store is also, of course, one of man's traditional sources of energy, either as wood or peat.

#### Practical Applications

A first and simple approach to the use of stored sunlight is to examine natural growth cycles, plant systems and present agricultural and industrial systems to see what plant material can be produced for use as fuel, or already exists as wastes from forestry or other crops. Raw biomass of this kind, utilised either as a feedstock, for fermentation to alcohol as fuel, or as a source of methane either as fuel or as a chemical feedstock for hydrocarbon and other synthesis, may provide a significant

addition to resources even within a couple of decades. The current estimate for Europe, for example, is that about 10 - 15% of all energy needs could come from such sources, without disrupting agriculture, by the turn of the century. Some countries, Brazil for example and more recently Australia, already have biomass programmes intended to meet transport fuel needs on a wholly renewable basis over the next half century. But this direct use of plant materials, which necessarily involves some conflicts of land use and which will be limited by the overall efficiency of energy conversion within natural plant systems, is only a starting point. In agriculture or forestry the overall efficiency of energy conversion is rarely better than 1% although in some fast growing crops — sugar cane for example — an efficiency of about 3% may be reached.

#### Conversion In Laboratory

When looked at in the long-term as a potential source of most energy and chemical feedstocks, this solar conversion rate implies the utilisation of such vast areas of land that it is impracticable. But research carried out at Queen Elizabeth College, London, by Professor S.J. Pirt and his team over the past five years or so, has shown that very much higher efficiencies can be achieved when conditions are right.

By selecting specific algal types and sifting for high efficiency strains, and then providing these algae with ideal conditions for growth, an overall conversion efficiency of better than 20% has been claimed in laboratory systems. It is envisaged that, in the medium term and perhaps with the assistance of genetic manipulation, algal and microbial energy conversion reactors — solar driven and of an efficiency and com-

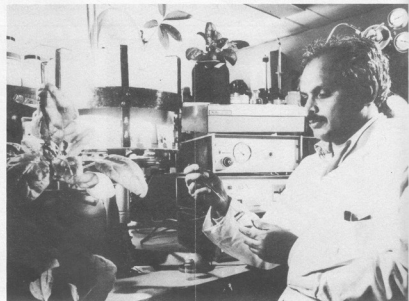

practise suitable for industry — could emerge as the basis for much of the future energy and chemical industry. In the laboratory, algal growth takes place within a flowing system which ensures an abundance of both light and nutrients at all stages — a sort of production line as compact as the tubes in a boiler. The systems already have a lean and industrial look about them, even though they still have some way to go.

But this approach, albeit practical, may not be ideal. The question being asked by research teams is whether it is possible to create in the laboratory relatively simple, efficient and stable analogues of the photosynthetic process in plants, but optimised for particular production purposes.

#### Reproducing photosynthesis

It has been shown already that bacteria and algae can be used as solar converters which produce hydrogen or ammonia from simple organic substrates. They are not fixing carbon dioxide as in classical photosynthesis, but these naturally engineered processes suggest that modification may be possible once they are properly understood. Even better from an industrial point of view, artificial photosynthetic processes which are capable of producing hydrogen (as a fuel), oxygen, fixed nitrogen or fixed carbon — a basis for almost all our needs — might be developed.

Some years ago it was shown that chloroplasts, extracted from living leaf structures and placed with suitable enzymes in water, would split water into hydrogen and oxygen under the action of light. This wholly (or mainly) natural biological system is relatively unstable and research, especially at King's College in London, has been aimed at identifying the various steps in the function of the chloroplasts to see whether artificial substitutions are possible.

In short, can stable synthetic chemicals be found to replace the biological molecules which are unstable outside plant systems? Various steps have been taken to stabilise the chloroplasts themselves — systems which worked only for minutes when first tried in the laboratory can now be made to work for many hours and various iron-sulphur and other compounds have been found which can take the place of natural compounds at some stages of the photosynthetic process.

#### Improving on plants

At the Royal Institution the research is seeking, not a direct understanding or analogue of the function of chloroplasts, but entirely synthetic systems in which the reaction takes place in an aqueous solution and is driven by light trapped

by the use of a dye. One of the first discoveries of recent research was a modified photogalvanic cell in which a light sensitive electrode (titanium dioxide) and a platinum electrode immersed in a solution of vitamin C (ascorbic acid) dyed blue, produced an electron flow with the simultaneous production of hydrogen and oxygen under the action of light. Efficiency was very low.

The question being asked is whether it is possible to carry out such a reaction directly in the solution — preferably using simple organic molecules as the substrate — while evolving hydrogen and oxygen. Using ketones, quinones and other compounds, low yields have already been achieved — an indication that much more may be possible. But there could still be a long way to go.

During the past five years the support for research of this kind, by industry and government, has steadily increased and progress has been made in the laboratory. But the overall effort is still small when compared with the ultimate goal.

(676 S)

selektor  
SELEKTOR

# farewell and welcome

*It is with regret that we have to announce the departure from the Editor's chair of Mr. Bob van der Horst. This will be felt as a great loss to the magazine as he not only founded the Elektor publishing company but spent many years of his life helping it to grow into the international corporation that now boasts six european language editions. All credit is due to Mr. van der Horst for his amazing abundance of energy and enthusiasm which 'rubbed off' on all staff and colleagues who worked with him. He will certainly be missed and we wish him well.*

*The successor to the 'front office' is a name well known in the English edition of Elektor, Mr. Paul Holmes. During the nine years that he has been with the company, P.H. not only started the English language edition but has been a driving force behind maintaining the high standards our readers have come to expect from Elektor. We wish him every success for the future.*

## JUNIOR COMPUTER BOOK 2 is available NOW!

the practical introduction  
to a powerful system



We know that your patience has been sorely tried, but we felt that 'high quality' was more important than 'high speed'. This book describes the I/O port (using a 6532), discusses the monitor routines in detail and explains the editor and hexadecimal assembler.

Book 3 is scheduled for September — give or take a month! — and Book 4 should appear a month or two later.

Book 2

Elektor

Speech consists of an ever changing, highly complex acoustic waveform. A multitude of factors are involved which we are unable to go into here, but the point is that even minor interference will affect speech intelligibility.

Scramblers are of course nothing new (007 has been using one for years!). They were extensively used by the military and other agencies during wartime before the advent of sophisticated codes made them somewhat obsolete. Early systems were designed with the discrete components available at the time with rather complicated results.

# scrambler

your own personal 'hot line'

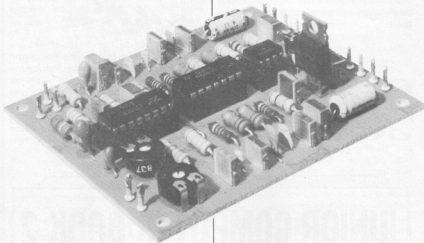

It may be useful on some occasions to be able to make use of a secure speech channel when messages of a 'delicate' or personal nature are to be passed to a friend or business associate. This is especially true where transceivers are concerned since its a virtual certainty that a number of silent listeners (or eawriggers) will be 'on the side'. The circuit described here will garble the speakers voice to such an extent that it will be entirely unintelligible to any unwanted listener.

It will be obvious that an unscrambler is also required and for this an identical circuit is used, it serves as both the scrambler and the unscrambler.

Scrambling is another word for distortion and this may give rise to some confusion. On the one hand distortion is often required for many specific musical purposes and a great deal of trouble is taken to create it with special effects devices. But on the other hand it is certainly not wanted in HI-FI equipment where designers go to extreme lengths to suppress it. Paradoxically, where scramblers are concerned, both requirements have to be met. The distortion process must be reversible. In other words, the scrambled speech must be able to be decoded or 'unscrambled' again afterwards.

The scrambler described here literally inverts the speech frequency spectrum. Thus, high frequencies are translated into low frequencies and vice versa. The result is totally unintelligible. The scrambler is shown in the form of a block diagram in figure 1. Since it was designed to distort speech it will only operate within the frequency range of the human voice. The low pass filter is therefore included to eliminate frequencies above 3200 Hz.

The filtered speech signal is fed to a linear ring modulator. This multiplies two signals with each other. It is a four-quadrant multiplier which means that the signals may assume both positive and negative values. The input signal is multiplied with an internal signal of 3200 Hz. The sum and difference frequencies of the two signals then appear at the output. An input frequency of about 300 Hz, for instance, would result in an output frequency of about  $3500 \text{ Hz} + 300 \text{ Hz} = 3800 \text{ Hz}$  and a difference frequency of  $3500 \text{ Hz} - 300 \text{ Hz} = 3200 \text{ Hz}$ . An input frequency of 3200 Hz would therefore give 6700 Hz at the output and a difference frequency of 300 Hz. The same formula applies to all the frequencies inbetween.

Figure 2 shows the principle in the form of a graph. The frequency spectrum of speech is shown at (A). If this spectrum is introduced into a four quadrant multiplier, two mirrored side bands will be obtained together with a frequency of 3500 Hz as shown in (B). The 3500 Hz oscillator frequency is derived from a permanently available 0 Hz ( $3500 \text{ Hz} + 0 \text{ Hz} = 3500 \text{ Hz}$ ; difference frequency  $3500 \text{ Hz} - 0 \text{ Hz} = 0 \text{ Hz}$ ). The permanent 3500 Hz will have to be filtered out as it will cause a 'whistle' in the scrambled signal. Filters have been included in the circuit, but as their turnover point is somewhere around 3500 Hz anyway, the oscillator frequency will not be sufficiently attenuated. The multiplier used here, in fact, is a balanced modulator with the advantage that the 3500 Hz oscillator will be missing from the output signal.

The multiplier is followed by a second low pass filter (speech filter) and it is here that the output signal will have its upper sideband removed. What now remains of the output will be a mirror image of the original speech spectrum. This is illustrated in (C). The speech output at this point will be totally 'garbled' and will remain unintelligible to any chance listener. Furthermore, the scrambler can be used to tape information of a classified nature.

So far so good, but to retrieve the information a decoder or unscrambler is required and since this is included in the scrambler itself, we can use the same block diagram to find out how it functions.

The unscrambler inverts the mirrored speech spectrum (C in figure 2) back to the original. Think of a set of two

mirrors in which the second reflects the image in its original form. Similarly, the inverted speech signal is merely inverted again. Whenever the unscrambler receives a scrambled message (A in figure 3), two side bands appear at the output of the four-quadrant multiplier. The result is shown in figure 3 B. As you can see, the lower side band has now reverted to its former state (figure 2 A). The upper side band is filtered out and the required, comprehensible result appears at the output (figure 3 C).

The unscrambler has to meet one important requirement - it must operate at an oscillator frequency that is identical to that of the scrambler. Any deviation and the frequency range will be shifted, so that the speaker's voice will end up sounding higher or lower. Obviously, this could have interesting 'Pinky and Perky' effects, but this is not the scrambler's main objective! If it is such effects that you're after, you might like to read the 'Talk funny?' article published in Elektor, December '79. By and large, the two circuits are based on the same principle.

### The scrambler/unscrambler circuit diagram

Figure 4 shows the circuit diagram for the scrambler/unscrambler unit. The first component to catch our eye is the familiar function generator IC XR 2206 (also used in the December '79 'Talk funny?' circuit). This IC contains, among other things, a four-quadrant multiplier that includes an oscillator which is really the heart of this circuit.

Opamp IC3 forms part of a preamplifier. The speech signal (whether scrambled or not) enters via the volume

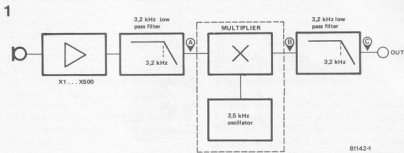

81142-4

Figure 1. The block diagram of the scrambler. The circuit can be used both to scramble and to unscramble speech. The most important component in the diagram is the four-quadrant multiplier. This not only manages to garble speech, it is also able to translate it back into its original, intelligible form.



81142-2

Figure 2. A stands for the speech spectrum which the scrambler receives. The four-quadrant multiplier converts it into two side bands (see figure B). A filter suppresses the upper side band and the result is unintelligible gibberish which is the exact 'mirror-image' of the original speech spectrum (figure C).

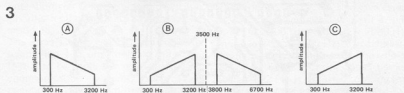

81142-3

Figure 3. If the unit is used as an unscrambler, the 'mirror-image' speech spectrum A will be inverted once again by the multiplier B and the original spectrum will reappear at the output (figure C).

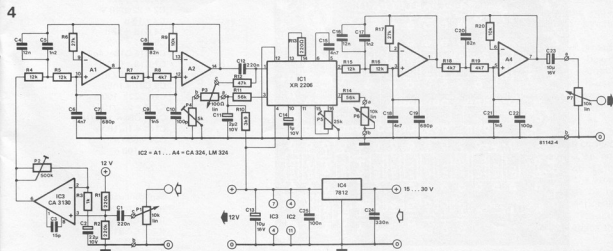

81142-4

Figure 4. The complete scrambler circuit diagram. Speech is garbled inside the XR 2206. IC3 amplifies the input signal until this reaches the required level. There is a low-pass filter at both ends of the four-quadrant multiplier (IC1). The first filter (A1/A2) defines the spectrum's range at the input of the multiplier, since excessively high frequencies are likely to cause interference. The second filter (A3/A4) suppresses the upper side band produced by the multiplier.

5

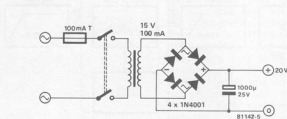

Figure 5. If the scrambler cannot be powered by the device to which it is connected this circuit diagram will provide a simple mains-powered solution.

6

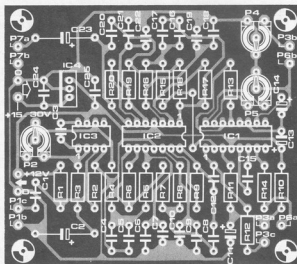
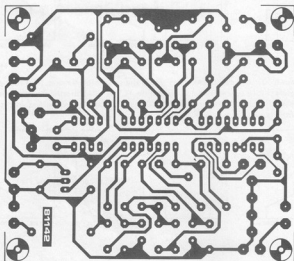
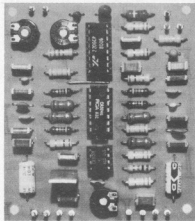

Figure 6. The copper track pattern and the component overlay of the scrambler printed circuit board. Two boards will be required unless the scrambler is to be used with a tape deck in which case one can be used for both record and playback.



#### Parts list

##### Resistors:

R1, R2 = 220 k  
 R3 = 1 k  
 R4, R5, R15, R16 = 12 k  
 R6, R17 = 27 k  
 R7, R8, R18, R19 = 4k7  
 R9, R20 = 10 k  
 R10 = 3k9  
 R11, R14 = 56 k  
 R12 = 47 k  
 R13 = 220  $\Omega$   
 P1, P6, P7 = 10 k lin.  
 P2 = 500 k (see text)  
 P3 = 100  $\Omega$  lin.  
 P4 = 5 k preset  
 P5 = 25 k preset

##### Capacitors:

C1, C12 = 220 n  
 C2 = 22  $\mu$ /10 V  
 C3 = 15 p  
 C4, C16 = 12 n  
 C5, C17 = 1n2  
 C6, C15, C18 = 4n7  
 C7, C19 = 680 p  
 C8, C20 = 82 n  
 C9, C21 = 1n5  
 C10, C22 = 100 p  
 C11\* = 2 $\mu$ /10 V  
 C13\*, C23 = 10  $\mu$ /16 V  
 C14\* = 1 $\mu$ /10 V  
 C24 = 330 n  
 C25 = 100 n

##### Semiconductors:

IC1 = XR 2206  
 IC2 = CA 324, LM 324  
 IC3 = CA 3130 (D1L)  
 IC4 = 7812

\* = Tantalum or electrolytic, for vertical positioning

control (P1). When the circuit is used to scramble a message, the input signal may be produced by a microphone. To unscramble a message, the input of the circuit must be connected to a source (telephone, receiver, amplifier or tape recorder). Preset P1 adjusts the gain between 1 x and 500 x. The best results are obtained when the signal at pin 6 of IC3 is in the 200 mV ... 1 V (effective) range. Using an opamp, such as the CA 3130 for instance, guarantees plenty of bandwidth even when amplification is as much as 500 x. R1 and R2 enable the output of IC3 to be offset by a DC level of about 6 V. This DC level is necessary to ensure that the filter following IC3 will operate correctly. For this reason, it is well to wait for a couple of seconds after switching on the supply voltage until the output of IC3 stabilises. It takes capacitor C2 a while to charge up to the required 6 V via P2.

On either side of the four-quadrant multiplier (IC1) is a low-pass (Chebishev) filter of the 4th order (24 dB per octave), which is built up around several opamps and features a turnover frequency of 3200 Hz. As we mentioned before, the DC offset of the first filter is supplied by the output of IC3 and that of the second filter by the DC voltage at pin 2 of IC1. The frequency of the oscillator inside IC1 can be adjusted by P6. Preset P5 controls the oscillator signal, ensuring this is symmetrical. This is necessary to prevent the original input from breaking through at the output. P3 and P4 are used to adjust the DC level of the input stage in the multiplier. When the latter is properly balanced, the oscillator frequency (3500 Hz) will be suppressed. It can always be corrected externally later, if required, with the aid of P3.

Any fluctuation in the supply will immediately unbalance the multiplier and so a well stabilised supply voltage is an absolute 'must' here. Use has been made of an integrated voltage regulator, type 7812. The DC input in the stabiliser may have a value between 15 and 30 V. Figure 5 indicates how to derive a voltage of some 20 V from the mains. If necessary, the scrambler may also be powered from the device to which it is connected. Current consumption is about 30 mA.

### Construction and calibration

Figure 6 shows the etching pattern and the component overlay of the printed circuit board. All the components indicated in figure 4 can be mounted on the board. It is advisable to use sockets for IC1 ... 3, as having to desolder them later, if for any reason they have to be replaced, can be a tedious job.

Since dissipation in the voltage stabiliser (IC4) is low, the IC does not need to be provided with a heat sink. If the scrambler is merely going to record speech in a coded form on tape, only one printed circuit board is required. It does mean, however, that P2 will have to be an externally adjustable potentiometer - not a preset. Then the circuit's input sensitivity can always be modified.

The same circuit can be used for both scrambling and unscrambling purposes. If it is to be applied in connection with communication systems, such as a telephone or a transmitter, a descrambler will have to be installed in the receiver as well. In other words, two boards are needed.

Once all the components have been soldered into place, the power supply

may be connected and it is time to calibrate the unit. The wipers of P1, P4 and P7 are turned to ground, whereas those of P3, P5 and P6 are set in a central position. P2 is turned to minimum resistance. The output of the scrambler is now connected to a combined amplifier/loudspeaker. Then P7 is turned until the oscillator signal is clearly audible. Now adjust the signal's frequency with P6 to 3500 Hz. Readers who do not have an oscilloscope or frequency counter at their disposal should set P6 in the middle position. The calibrated position of P6 should be marked on the front panel. Whenever signals are being scrambled, this is the position that P6 should be in. During an unscrambling operation, it is possible to readjust P6, should this prove necessary.

When the block diagram was described, it was mentioned that the 3500 Hz tone should be eliminated from the output signal. It will have to be suppressed with potentiometer P4. Unfortunately, it hardly ever happens in practice that the interference is 'tuned' out altogether; however, it can be reduced until it is barely audible. Once the suppression is optimally set (the multiplier will then be balanced), any 'relapse' due to a change in temperature can be corrected with P3.

Now connect a 600 Hz sinewave signal to the input and turn P1 until a high tone (= 3500 Hz - 600 Hz = 2900 Hz) and a low tone (600 Hz) can be heard simultaneously. If necessary, the gain of IC3 may be further increased by adjusting P2. P5 is adjusted to suppress the 600 Hz tone as much as possible, so that, in the end, only the 2900 Hz tone will be left.

Don't worry if your generator cannot produce a 600 Hz sinewave signal. Figure 7 gives the circuit diagram for a suitable test generator that can be mounted on a piece of Veroboard. This generator can be fed with the stabilised 12 V voltage produced by the scrambler.

After calibration, the scrambler is ready for use. Now that the two boards (including a mains-powered supply) have been built, they can be checked quite simply by connecting them in series. The first board will then act as the scrambler and the second as the unscrambler. Connect a microphone to the input of the first board and connect the output of the second to an amplifier/loudspeaker unit. Provided the circuit is properly calibrated, the voice of the speaker should at least be recognisable ... but don't expect HiFi quality. You may have to readjust P6 in the unscrambler and/or adapt the unit's sensitivity with P2.

Now remove the second board (unscrambler) and the 'language' uttered by the amplifier/loudspeaker unit should not be recognisable!

7

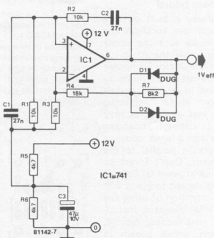

Figure 7. Readers who do not have a generator at hand that is capable of producing a 600 Hz sinewave signal, will find this straightforward test oscillator quite a handy solution.

# the junior reaches maturity

This is the final article on a very important stage in the development of the Junior Computer — the extension boards. All constructional details will be covered together with modifications to the main board and the power supply. It will be apparent that Junior will become too big for its original case and will therefore require a new one — many readers may welcome the change!

As in the previous two articles on the extension card this can only be a relatively brief summary of the constructional details required to build and fit the boards to the Junior Computer. The subject will be covered at length in the forthcoming Junior Computer Book 3 but sufficient information is presented in this article to enable readers to get to grips with the hardware now.

The addition of the extension card will involve a few minor alterations to other areas of the computer.

— certain modifications have to be made to the main board (some are optional);

— the power supply will have to be adapted to allow it to cope with the added current required;

— the interface card can then be mounted and linked to both the main board and the bus board and finally

— the PLL must be calibrated.

There are in fact further extension possibilities which will not be discussed here but will be considered at length in Book 3.

## Preparing the main board

When an upper storey is built on to a house, it is a good idea to check the foundations and make sure the whole lot won't collapse under the strain... Actually, as far as the Junior Computer is concerned, there isn't that much to do (see Table 1) and, in any case, people who feel wary about removing components may rest assured, as they have the choice between changing resistors (for ones with a lower value) or connecting resistors in parallel to the ones already present. Don't forget to modify the wire link at point D! Point D should now be connected to point EX. Readers with the intention of using the Printer Monitor (PM) program, including the step by step reading facility, should include the circuit shown in figure 2b. This is a special module which can be mounted on the main board in the manner indicated in table 2. The module's component overlay and printed circuit board are shown in figure 1. Figure 3 shows how to mount

and wire the module.

The need for the circuit in figure 2b was explained in the 'Junior Cookbook' article (Elektor, April 1981, p. 4-28/29). Two ports belonging to IC10 which were not used before, now come into their own. This supplementary circuit is mounted 'piggy-back' on top of the main board.

There will be no problem here if IC10 is mounted in a socket. If not, a socket will have to be installed after first removing the IC by careful application of pencil point soldering iron and a good quality 'solder sucker'. Alternatively, the pins of the IC can be 'snipped' off and removed with a pair of needle-nose pliers. Operate with care and a steady hand!

The module that is to be mounted contains a substitute for IC10, two resistors and two solder pins to connect the K lines. On the copper track side, only pins 1, 2, 4... 7 and 14 will be used. These act as links with the socket which has just been mounted on the main board in place of IC10. Pins 3 and 8... 13 are not used and can be cut off. As an alternative seven pieces of wire may be used to link the module directly to the main board.

Now the K lines are dealt with. If the PM program is desired, K4 (together with K5, as will become apparent) and

Table 1.

Modifications to the main JC board
R5 = 470 $\Omega$ (or 560 $\Omega$ in parallel to 'old' R5) — indispensable
R14, R15, R16 = 470 $\Omega$ (or 560 $\Omega$ in parallel to 'old' R) — optional
1 wire link D-EX

Table 2.

module EPS 81033-3
R21, R22 = 1 k (continuation of numbers on main JC board)
IC10 = 7401, 74LS01 (only if original IC10 has to be desoldered)
1 printed circuit board EPS 81033-3
1 IC socket 14 pins (provided IC10 was not already in socket)
1 IC connection socket (see text)
2 solder pins

1

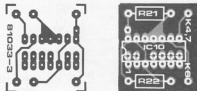

Figure 1. The 'piggy-back' board, which includes the circuit shown in figure 2b, replaces IC10 on the main board.



K6 will be connected to IC10. The module will enable decimal calculations to be carried out without any problem, even without the use of the PM program. In the latter case, K7 and K6 are linked to IC10.

### Boosting the supply

*How to get a few more (milli) amps ... and minus 12 V*

The circuit diagram of the modified power supply is shown in figure 4a and the printed circuit board for the -12 V circuit is drawn in figure 5. The parts required are listed in table 3 and the constructional details are given in figures 4b and 6.

'Feeding the five thousand' does not apply in electronics. There may well be enough power for two boards, but not necessarily for three! Especially where EPROMs are concerned, as they are particularly greedy components. In addition, there will have to be a -12 V supply for the RS 232 interface. The 'revised' Junior Computer power supply produces:

- +5 V, 4 A max.
- 5 V, 400 mA max.
- +12 V, 400 mA max.
- 12 V, 400 mA max.

This will amply feed the main board,

the extension card and 5 additional memory cards (the Elekterminal has its own power supply). What is needed therefore is to add a separate -12 V supply on a suitable printed circuit board, modify the existing supply, include another transformer, provide the larger +5 V voltage regulator with a heat sink and adapt the wiring. Figure 6 gives the necessary ingredients to 'cook up' this extra bit of power.

On the existing printed circuit board D1 and D2 are removed (they can now be used for D7 and D8) so are IC1 ... IC3 along with the heat sink. After virtually demolishing the board it is time to build it up again: C19 is connected in parallel to and above C1. It is also possible to replace C1 by a 680  $\mu$ F/40 V electrolytic capacitor. Likewise, C21 is mounted in parallel with C6. Again, C6 may be substituted for an electrolytic 4700  $\mu$ F/25 V capacitor. It all depends on what happens to be available.

Next, the new ICs 1 and 3 are introduced to replace their predecessors and are mounted on the board. Read and reread the following very carefully: *the metal face of each IC is situated to one side of C2*. In other words, don't take any notice of the component overlay. The two ICs should be provided with a heat sink, as shown in figure 4b. The centre pin of each is linked internally to

the metal face and therefore to the heat sink. It is quite obvious from the pin assignments in figure 4b that *the heat sinks of IC1 and IC3 should not touch*. The solution is to bend the pins of one of the ICs while keeping them vertical and then mount the two heat sinks so that they face in opposite directions.

The new IC2 is mounted on a pre-drilled TO3 heat sink which can be fixed to the back of the case. The pin assignment of the 78H05 is identical to that of the LM 309K. There is no need to insulate the IC, as its case is grounded. The whole supply case will therefore automatically be earthed as well, provided it is made of conductive material! Watch out for shorts between the case and conductive components (caused by metal spacers, for instance!). The supplementary power supply board is very easy to construct. IC4 should have a heat sink as well (see figure 4b). With respect to the +5 V, this will require an additional transformer (Tr2). The bridge rectifier B1 is a newcomer too. This can be mounted (without being insulated) at the bottom of the power supply case. It is best to use four terminal connectors when wiring B1.

Time to wire the board. Things get slightly more complicated here, but the drawings should be clear enough. The power supply is connected to the

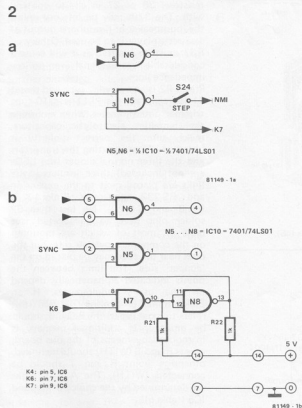

Figure 2. The Junior Computer: before (2a) and after (2b): additional electronics on the main board as an alternative to the step-by-step facility in some cases.

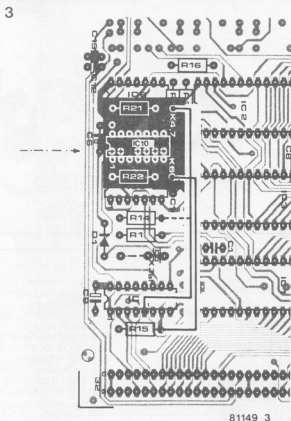

Figure 3. This is how the board in figure 2 is connected to the main board. Two wire links are involved: one leading to K6 and one to either K4 or to K6.

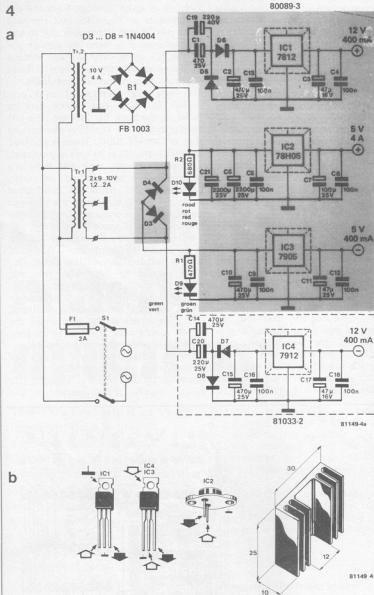

Figure 4. The 'revised' power supply (4a) and various practical considerations (4b).

Table 3.

Parts list for revised power supply  
(additional board: EPS 81033-2: -12 V  
power supply)

NB. '%' stands for 'modified'  
'&' for 'new' (numbers run on)

Capacitors:

C1, C2, C10, C14(&), C15(&) = 470  $\mu$ /25 V  
C3, C11, C17(&) = 47  $\mu$ /16 . . . 25 V  
C4, C5, C8, C9, C12, C13, C16(&),  
C18(&) = 100 n MKH  
C6, C21(&) = 2200  $\mu$ /25 V (C21//C6)  
(of C6(%) = 2200  $\mu$ /25 V; C21 is left out)  
C7 = 100  $\mu$ /25 V  
C19(&), C20(&) = 220  $\mu$ /40 V  
(C19//C1; C20//C14) (C19 and C20  
are omitted when C1(%), C14(%) =  
680  $\mu$ /40 V)

Semiconductors:

IC1 (%) = 7812 (TO - 220)  
IC2 (%) = 78H05 (TO - 3)  
IC3 (%) = 7905 (TO - 220)  
IC4 (&) = 7912 (TO - 220)  
D1, D2 are omitted; see D7 and D8  
D3, D4, D5, D6, D7(&), D8(&) = 1N4004  
B1 (&) = FB 1003  
Tr1 = existing transformer  
Tr2(&) = 1 x 10 V 4 A transformer  
S1 = existing mains switch  
F1 (%) = 2 A-fuse  
(&): heat sinks for IC1, IC2, IC3, IC4

indicators:

D9 = green LED; R1 = 470  $\Omega$   
D10 = red LED; R2 = 680  $\Omega$

extended Junior Computer system by way of the five solder pins on the interface card provided for the purpose.

## The interface card

### The main connection

Last month the circuit diagrams were published in the article on the hardware. The parts list is indicated in table 4 and the printed circuit board is illustrated in figure 7. Both sides are shown in the same drawing to save space! The wire links for ICs 4 and 5 must be installed according to table 5 and details concerning the connectors are presented in figure 8.

The printed circuit board is double-sided with plated-through holes like the main board. There is, however, one fundamental difference between the two boards: the interface card has a component overlay on one side only. This does not mean the components are all mounted on that side. Most of the connectors will in fact be placed on the other side (not on the component overlay!)

Generally speaking, the component overlay is considered to be the upper side. Well, we'll have to break with this tradition, as we're going to make a sandwich with the upper 'slice' being the interface card. Watch your fingers, because the 'battered' side is going to be on the outside! First of all, there are the resistors, 36 or 37 in all, to contend with. The 37th may be left out unless the loudspeaker or headphone output of a cassette player is to be used. Otherwise R37 must be omitted as it will cause a considerable loss of signal even on low impedance lines.

Preset P2 is an everyday type and preset P1 (to calibrate the PLL) is a 10 turn trimmer potentiometer. When mounting the tantalum electrolytic capacitors, make sure the correct polarity is observed. After inserting the transistors and the three normal diodes (the LEDs are not included) three insulated wire links are placed next to the expansion and RS 232 connectors (links 4 & 5, 5 & 8 and 6 & 20). No less than 62 solder pins have to be located (see table 4), most of which are mounted on the component overlay side, but the ones near the edge may be placed on the 'copper' side. The links between the points indicated alphabetically depend on the user's requirements. If an Elektterminal or a printer is used (this refers to most types) the P-Q link should be omitted. If additional memory is introduced by means of the bus board, points R and S (WITH) should be linked, otherwise points R and T should be connected (WITH). The A . . . O links are determined by the choice of IC4 and IC5 (table 5).

It is advisable to provide the 17 ICs and the two Reed relays with good quality sockets. When mounting the ICs in their corresponding sockets, first check their position and then make sure the 8, 14, 16, 18, 20, 24 or even 40 pins have well

and truly penetrated into the socket. Very often pins get twisted and flattened underneath the ICs ... leading to irate telephone calls on Monday afternoons, quite unnecessary if due care is taken!

At least one IC will have to be programmed: this is the PROM IC17. Provided it is an 82S23 type, it can be programmed using the PROM programmer which was published in the 1980 Summer Circuits' issue. If IC4 is to be an EPROM, this will have to be programmed as well.

If a 2716 containing the TM program is not used, everything that refers to the cassette interface may be omitted. The same is true of IC5. If the G and S functions that are involved in the PM program are used, the TM routine must also be available. (see the 'sophisticated software' article in the May issue). On the other hand, relays Re1 and Re2, their corresponding sockets and J3 and J4 are rendered superfluous, if software control using a cassette recorder is deemed unnecessary.

### The connectors and other links

The interface card requires at least three connectors (not counting the 'connector' belonging to the VIA). The input connector is mounted on the component overlay side. This is the nucleus of the entire connection network between the interface card and the main board (see figure 8a). The output (expansion) connector is mounted on the copper track side of the board (figure 8c). This is only employed if the memory is to be further extended. Alternatively, the two boards may be linked with wires, in which case the connectors will not be needed at all. The wire option carries a certain amount of risk, as it may lead to shorts, but of course you are welcome to give it a try!

Then there is the RS 232 connector (figure 8e). This is also mounted on the copper track side, in fact it has to be, as otherwise the line network would be inverted. If the chassis connectors J1 ... J4 are mounted to the side or back of the case instead of on the copper side of the board, screened cable will have to be used.

### Put your cards on the table

#### Bird's eye view of the system

The full constructional details are shown in figure 9 and the connectors can be found in figure 8. With regard to the latter there is a small problem ... The output connector cannot be mounted in the normal manner by inserting it and then soldering the 64 pins. In view of the position of the two rows of 32 holes, the connector cannot be placed on the edge, but must be placed on the board itself. The pins pass through to the other side at a pinch and could in fact be soldered, but it is

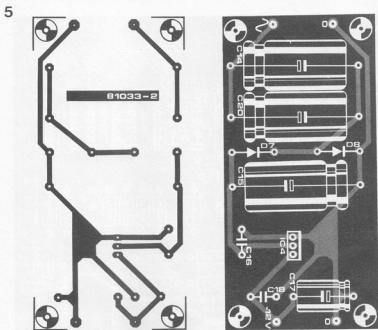
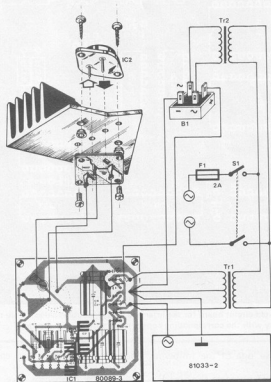

Figure 5. The -12 V power supply board.

6



81149 6

Figure 6. The constructional drawing for part of the revised power supply.

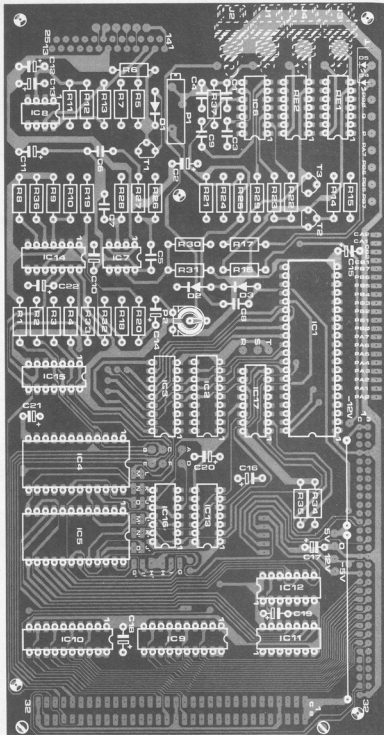

Figure 7. The printed circuit board for the interface card is 'doubled-sided'. Only the component overlay with the corresponding copper track pattern is illustrated.

better to choose one of the following solutions:

- Using a pair of tweezers the pins can be bent to gain a few extra millimetres (see figure 8c).
- Take a connector of the type shown in figure 8b with pins that are at least 13 mm long (wire wrap type) and again

bend them so that they easily fit into the holes.

- Take a connector like the one in figure 8b and connect it to the board by means of 64 wires (hardly ideal!).

The parts list is printed in table 6. The interface card is exactly the same size as the main board, enabling the two cards

Table 4.

Parts list for the interface card

Resistors:

- R1, R2, R3, R4, R32, R33, R34, R35 = 1 k
- R5 = 22 k
- R6, R10, R11, R14, R15, R24, R26, R27, R28 = 10 k
- R7, R8, R36 = 8k2
- R9, R18, R22, R23 = 4k7
- R12 = 6k8
- R13, R25, R31 = 2k2
- R16 = 100 Ω
- R17 = 330 Ω
- R19 = 470 Ω
- E20 = 1k2
- R21 = 15 k
- R29 = 33 k
- R30 = 4M7
- R37 = 33 Ω (see text)
- P1 = 5 k (4k7) multiturn preset
- P2 = 1 k preset

Capacitors:

- C1 = 220 n MKH
- C2, C11, C12, C13 = 10 μ/16 V tantalum
- C3 = 22 n MKH
- C4 = 1 n MKH
- C5, C6, C7 = 6n8 MKH
- C8 = 100 n MKH
- C9 = 47 n MKH
- C10, C14... C22 = 1 μ/16 V tantalum (total 10)

Semiconductors:

- T1 = BC 547B
- T2, T3 = BC 516
- D1, D2, D3 = 1N4148
- D4 = LED green
- D5 = LED red
- IC1 = 6522 (Rockwell, Synertek)
- IC2, IC3 = 2114
- IC4 = 2716, 2708, 8114
- IC5 = 2716, 2708, 8114
- IC6 = 565
- IC7, IC8 = 311
- IC9, IC10 = 74LS241
- IC11, IC12 = 74LS243
- IC13 = 74LS27, 7427
- IC14 = 74LS01, 7401
- IC15 = 74LS30, 7430
- IC16 = 74LS00, 7400
- IC17 = 82S23, 74188

Miscellaneous:

- Re1, Re2 = DIL reed relays (Günther 1301, 3802)
- 28-pin IC sockets
- 9 14-pin IC sockets
- 1 16-pin IC socket
- 2 18-pin IC sockets
- 2 20-pin IC sockets
- 2 24-pin IC sockets (see text)
- 1 40-pin IC socket
- 5 wire links on board (in addition to ones marked alphabetically)
- J1... J4 = cinch chassis connectors
- 1 25-pole D connector (RS 232), mounted at right angles to board (see figure 8e)
- 20 solder pins (VIA 'connector')
- 29 solder pins (marked A, B, C, etc.)
- 1 input connector (64-pin) placed at right angles, DIN 41612, male (is identical to expansion connector in standard JC) — see figure 8a
- 5 solder pins (links to port connector)
- 5 solder pins (links to power supply)
- 3 solder pins (LED connections)
- 1 output connector (64-pin) placed at right angles, female (see figure 8c and text)

to be 'sandwiched' together, which saves a lot of space. There is one important consideration to bear in mind, however; the main board contains the keyboard which will obviously have to be within finger-tip reach, thus with the interface card below it, but with as little space between them as possible. The links will have to be kept short!

Now let us consider the interface card from the following angle: the component overlay facing downward, the input connector facing west, the RS 232 connector facing east and the output connector facing north. The next 'floor' consists of the main board with the keys facing you, which is logical. The space between the two cards depends on the size of the two switches S24 and S25. The whole unit will be more compact if these and the RS 232 connectors are removed and placed elsewhere on the case.

This brings us to the case. Ideally, it should be in the form of a lectern or desk with enough room in it for the main board/interface card sandwich, the power supply and the bus board and memory extensions. However, this is just a suggestion, as of course the number of equally suitable possibilities is legion. Please inform us if you come up with any original ideas!

Figure 9a provides an elegant solution towards linking the interface and main boards. The connectors are equipped with one female connector each, as shown in figure 8b. These will be interconnected either by means of part of the bus board described in January 1980 (EPS 80024) or by means of ribbon cable. Using the bus board mentioned above will involve a rather delicate operation: it will have to be cut to size. Thus, the distance between the two connectors on the bus board will largely determine the space between the two cards.

N.B. The copper tracks on the bus board are asymmetrical. Points 3 and 4 are joined by wide tracks. If the bus board is used the other way around, lines 30 and 29 will act as lines 3 and 4. These are not wide, however. Looking at the sandwich as drawn in figure 9a, point 32 is in the foreground and point 1 is in the background.

The interface card has five mounting holes, just like the main board, so that the two boards can be sandwiched together with ease and precision. It is advisable to use fairly solid spacers (metal ones can cause short circuits — beware!). The interconnections between the two boards are illustrated in figure 9b. The use of the bus board mentioned above is highly recommended, but it is also possible to make your own.

If the ready-made bus board is employed, note the asymmetrical copper tracking. Holding the double-decker sandwich in the position described earlier (figure 9a), point 32 of the bus board will face west and point 1 will face east.

That by no means covers all there is to

Table 5.

Wire links around IC4 and IC5

IC	memory	type	G...O G'...O'	A...F	memory range
IC4	1K-RAM	8114	O - M	A - B	0800 ... 0BFF
	1K-EPROM	2708	O - N G - H J - K	A - B	0800 ... 0BFF
	2K-EPROM	2716	O - N G - I J - L	A - B - C <sup>1</sup>	0800 ... 0FFF <sup>1</sup>
IC5	1K-RAM	8114	O' - M'	D - C <sup>2</sup> D - E <sup>4</sup>	0C00 ... 0FFE <sup>2</sup> 1000 ... 13FF <sup>4</sup>
	1K-EPROM	2708	O' - N' G' - H' J' - K'	D - C <sup>3</sup> D - E <sup>4</sup>	0C00 ... 0FFE <sup>3</sup> 1000 ... 13FF <sup>4</sup>
	2K-EPROM	2716	O' - N' G' - I' J' - L'	D - E - F <sup>5</sup>	1000 ... 17FF <sup>5</sup>

1) Meant for system program TAPE MONITOR (TM)

2) Preferable if IC4 = 8114 (continuous RAM range)

3) Preferable if IC4 = 2708 (continuous EPROM range) of if IC4 = 8114 (continuous memory range)

4) When IC4 = 2716

5) Meant for system program PRINTER MONITOR (PM)

NB. Various other K connections are possible, only the most logical choices are mentioned in the table.

8

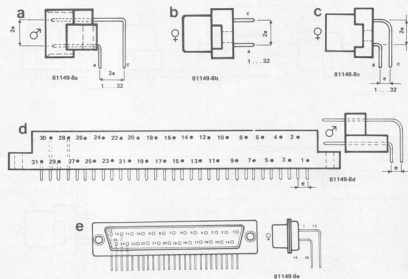

Figure 8. Data for all the connectors involved in the extension of the Junior Computer.

Table 6.

Electrical connections for the entire unit

- a. between main board and interface card
  - 2 64-pin connectors, female (see figure 8b)
  - 1 printed circuit board EPS 80024 (partly used) or 1 piece of Veroboard (2.54 mm hole pattern)
  - 1 31-pin male connector (see figure 8d)
- b. between interface card and bus board
  - 1 64-pin male connector placed at right angles (see figure 8a)
  - 1...5 64-pin female connector(s) (see figure 8b)
  - 1 printed circuit board EPS 80024 or 1 piece of Veroboard (with 2.54 mm hole pattern)

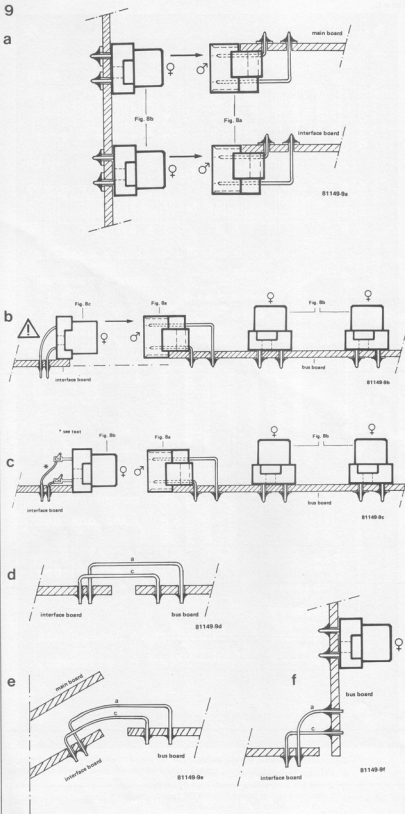

Figure 9. Detailed view of the electrical connections between the main and interface boards (9a) and between the interface and bus boards (9b, 9c and 9d).

say about the bus board. According to what is marked on the connectors, pins 'a' will be on the edge of the card and so the 'c' pins will be towards the middle. Watch out for the misprint on the component overlay of the bus board, near the connectors, where 'a' and 'c' have inadvertently been swapped round. N.B. The reference to the 'a' and 'c' pins in figure 8 are quite correct, but do not correspond to those on the component overlay!

If the interface card and the bus board are linked by ribbon cable, in other words, without using connectors, it is particularly important to make sure 'a' and 'c' do not get mixed up. The wires leading to both points will be equal in length (see figure 9d). (If the component overlay were correct in this respect, the 'a' wire links would be much shorter than their 'c' counterparts).

The bus board is best positioned with point 1 facing right (east) as seen from the interface card.

Figure 9b shows how the output connector of the interface board is mounted on the card: the bus board will not be level with the interface card. Figure 9c, on the other hand, shows the connector mounted against the interface card and here the two cards are level with each other, which is preferable as it saves having to adjust the spacers, etc. The two cards are also linked by way of the port connector. For this either a male connector or terminals are used (the connector pin assignments are provided in figure 8d).

## The PLL control

### Reading data without spelling mistakes

So far the interface card is mounted, the 'new' power supply is ready and IC4 is a 2716 containing the TM program. Get set... Depress RST to jump to the standard monitor routine, then enter AD 0810 (start address of TM) and depress GO: 'id 00' will appear on the display. Now to calibrate the PLL to allow data transfer from the cassette tape to take place without a hitch. We have already explained how the PLL works. The VCO frequency must be adjusted to about 3 kHz with the aid of P1, when no input signal is available. Nevertheless, it will be seen that calibration does not necessarily have to take place without an input signal.

Two routines (table 7) co-operate in the procedure. The first (0200...0250) uses a TM subroutine and provides about 4 minutes' worth of synchronisation characters which are recorded on tape. The second (0251...0283) monitors the synchronisation character reading from the tape, with the assistance of four TM subroutines.

P1 should be adjusted in such a way that these characters are read on tape correctly. This can be seen on the display: the configurations that are likely to appear were published in figure 3 in last month's issue in the

article on the 'sophisticated software'. P1 will be properly adjusted when the situation, as shown in the second drawing in figure 3, is stable. That is to say, when the display does not flicker between drawings 1 and 2.

The calibration procedure takes place in the following steps:

1. The machine is switched on and the programs given in table 7 are entered.
2. The cassette recorder is connected. P2 is turned fully on and the recording level of the cassette recorder is set in the mid position.
3. The recorder is switched to 'record' and is started. Enter: AD 0200 GO. The red LED lights and the synchronisation characters are recorded.
4. After about 4 minutes the write operation will have been completed. The red LED will go out and 0200A9 appears on the display. The cassette recorder is stopped and the 4 minutes' tape is rewound.
5. Start the recorder on 'play' (read) this time and enter: AD 0251 GO. If the headphone of the cassette recorder is used, turn the volume up half-way. The green LED lights. If we have reached the tape section that precedes the synchronisation characters drawing 1 in figure 3 belonging to the software article will now be displayed. This will flash! However, once the synchronisation characters are being read, the PLL can be calibrated.
6. Turn P1 (with a screw-driver) until the second drawing appears on the display. *If this does not alter for the entire synchronisation character reading, P1 is sure to have been properly adjusted.* To be absolutely sure this procedure should be repeated a few times. We are not going to tell you in which direction to turn P1, as this depends on certain parameters which are rather complicated and cannot be dealt with here.

Table 7.

The hex dump of the two test programs used to calibrate the PLL.

```
M
HEXDUMP: 200,250
  0 1 2 3 4 5 6 7 8 9 A B C D E F
0200: A9 7D 8D 6C 1A A9 C3 8D 6D 1A A9 03 8D 76 1A A9
0210: 02 8D 77 1A A9 47 A2 FF 8D 82 1A 8D 78 1A 8E 83
0220: 1A A9 00 A2 7F 8D 80 1A 8E 81 1A A9 DD 8D 00 1A
0230: 8D 01 1A 18 A9 01 6D 00 1A 8D 00 1A A9 00 6D 01
0240: 1A 8D 01 1A B0 08 A9 16 20 A3 0A 4C 33 02 4C 1D
0250: 1C
```

JUNIOR

```
M
HEXDUMP: 251,283
  0 1 2 3 4 5 6 7 8 9 A B C D E F
0251: A9 32 8D 82 1A 8D 78 1A A9 7E 8D 83 1A A9 7F 8D
0261: 81 1A A9 FF 8D 6B 1A 20 C2 0B 6E 6B 1A AD 6B 1A
0271: 20 E8 0B C9 16 D0 F0 20 36 0C 20 5D 0C C9 16 F0
0281: F6 D0 DF
```

JUNIOR

## EOT

*End Of Text . . . end of the road or turning point?*

Right, it's up to you now! We hope the trilogy on the interface card has supplied readers with enough information. Obviously, there are plenty of details to fill in. Judging by the letters that we've been receiving lately people seem to think the sun rises and sets out of PASCAL and BASIC! But what about machine language? Assembler, for instance, is a very interesting proposition so why not make the effort? It's boring wanting to do everything the easy way! As for the ASCII keyboard and the Elekterminal, readers are recommended to read the following articles:

- Elektor, November 1978, p. 11-06, ASCII keyboard.
- Elektor, December 1978, p. 12-16, Elekterminal.

Your soldering irons must be white-hot by now, so it's high time you got started. There should be plenty to keep you occupied and off the 'phone until books 3 and 4 are available. **M**

# coming soon...

## Summer circuits

The next issue of Elektor will be the July-August Summer Circuits double issue with its usual quota of over 100 circuits.

Some circuits are basic design ideas, others are complete with printed circuit board layouts. With subjects ranging from audio to microprocessors every reader will find something of interest. Just to whet your appetite, here is a list of a few of the proposed articles;

- audio level meter
- proximity detector
- loudspeaker overload indicator
- frequency and phase detector
- temperature alarm
- Hi-Fi siren
- EPROM light organ
- binary keyboard
- crystal tuning fork
- digital alarm for car
- 50 Watt car booster
- digital sine wave oscillator
- over 90 other circuits

## September

- TV games: the TV games extension board didn't fit in this issue. We're holding it for September. A TV games book and two more tapes will also be available at that time.
- Teletext, Elektor-style. For this type of construction project to be practical, connections to the TV set must be considered. Manufacturer's application notes make interesting reading, but they are of little value to the home constructor.

We seem to have reached the point where our hands have grown virtually useless. First mechanics and then electronics took over. Even the simplest of manual jobs now have an electronic alternative. The pre-electronic era now strikes most members of the younger generation as belonging to the distant past, like the Stone Age. This is hardly surprising, considering that such 'ordinary', everyday devices as sewing machines and cameras are all controlled by a built-in computer these days and are even designed to check every possible (and often impossible) error on the part of the operator. Thermometers 'won't work' unless they provide a digital reading and irons are likely to be computerised any minute, in which case you will no longer be allowed to burn a decorative hole in your own shirt . . .

C. Nötzel

# water level indicator

## electronic 'flower power'

Did you know electronics had green fingers? With a little current and water, potted plants can be encouraged to grow and blossom. A row of LEDs are used to indicate the level of water in the pot, so that the gardener knows exactly when to water the plants.

Anyway, there is no point in leading readers up the garden path, for, as everyone knows, there are plenty of positive aspects involved in electronics. Surrounded as people are by all sorts of electronic home comforts, taking them for granted is easier said than done. For one thing at Elektor we earn our bread and butter from chips!

### Interesting and so easy

Electronics can be fun. What's more, it does not have to be complicated. This water level meter circuit, for instance, is a perfect example of both.

Using a couple of ordinary logic gates and a row of LEDs, an amazing amount of 'flower power' can be generated. This is particularly useful for hydroculturists (owners of special hydroculture pots), as the circuit consists of a water level indicator with LEDs to indicate how much water there is in the pot and when to add more.

Readers who can stand up to flower power, but find it irresistible, should look at figure 2. The sensor is shown towards the bottom of the circuit diagram in the form of a long copper strip

with ten smaller segments alongside it. When the 'gauge' is dipped into water, the resistance between the small copper areas and the long strip will decrease and the meter will be activated. The exact procedure is as follows:

When the pot has sufficient water, the low transitional resistance between the contacts of the 'gauge' will cause all the

1

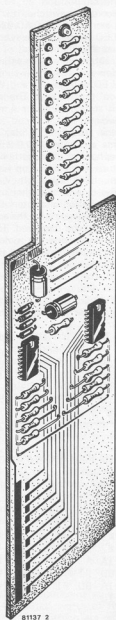

Figure 1. How to construct the meter board. The length of the sensor will have to be empirically established. In the prototype model this was about 5 cm.



inputs of inverters N1...N10 to go 'low'. Their outputs will then be 'high', so that the LEDs, D1...D10, will be confronted with two high logic levels and will therefore *not* light. Only D11 will light, for its anode is connected to the high output level of N10 by way of R24, but at the same time its cathode is directly linked to the supply's ground. Its light indicates that the pot has sufficient water.

If the water level drops until the upper segment of the sensor is left high and dry, the resistance in this area will suddenly rise considerably. The input of N10 will now go high via resistor R10 and its output will accordingly go low. As LED D11 now hovers between two low logic levels, its light will go out. D1...D9 will remain unchanged, that is to say, they will stay unlit. D10, however, will light under the influence of the high output level of N9 at its anode and of the low output of N10 at its cathode. Thus, the procedure is really quite straightforward: whenever the water level drops a 'rung' on the meter, the next lowest LED will light and so on, enabling the soil's moisture to be very easily monitored.

In addition, the meter includes a 'luxury item'. If the 'gauge' is allowed to dry up, the lowest LED in the row (D1) will light and the configuration at D13...D16 will cause the AMV around N11 and N12 to be activated. LED D12 will then flash to indicate that it is high time the plants were watered. Since D16 is linked to the output of N10, LED D12 will continue to flash until the water level has reached the highest copper segment but one.

Unfortunately, there was no time to design a printed circuit board for the water level indicator. The circuit is not difficult, however, and most readers should be able to make a board themselves. Figure 1 illustrates what the meter looks like after construction. Of course, the correct length of the sensor and the amount of space between the copper segments will depend on the size and shape of the flower pot. **M**

2

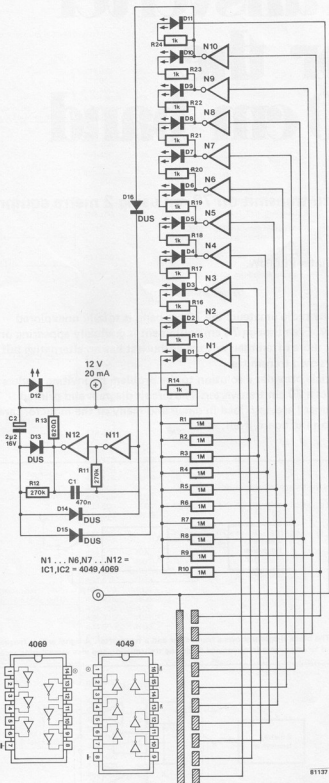

Figure 2. Electronic flower power. The water level can be read on an LED scale; an LED will flash to indicate when the plants need watering.

# transverter for the 70 cm band

## how to transmit on 70 cm using 2 metre equipment

P. de Winter PE0PJW

For many radio amateurs the 70 cm band is totally unexplored territory. Even though 70 cm equipment is gradually appearing on the market, more often than not the enthusiast has no alternative but to build his own transmitter.

This article provides a solution to the problem by inviting readers to construct a 70 cm transverter. The circuit diagram and printed circuit board are described in detail and many of the inductors are etched on the board itself.

1

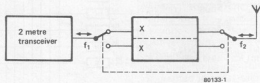

Figure 1. The block diagram shows a transceiver and a transverter. A signal with a frequency  $f_1$  is converted to one with a frequency of  $f_2$  during transmission and vice versa during reception.

2

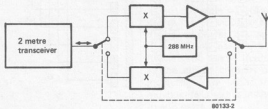

Figure 2. The simplest form of transverter mixes a signal of 288 MHz with one of 144 MHz (during transmission) or with one of 432 MHz (during reception).

Radio amateurs who wish to make use of the various bands in the VHF/UHF range are faced with the choice of either buying a complete transceiver for each band, or of buying a single unit, such as a 2 metre set for instance, and operating it with a collection of converters. The latter option is much cheaper, especially if the converters are 'home-constructed', and is therefore preferable. The transverter described here allows a 2 metre (144...146 MHz) transceiver to be operated on the 70 cm band (432...434 MHz).

As can be seen from the frequency spectrum shown in table 1, this particular frequency range occupies most of the portion of the 70 cm band that is available for use by radio amateurs. This is important as both telephone and telegraph communications also take place in this band.

Compared to the busy 2 metre band, the 70 cm band is a welcome relief. This is because the majority of people do not feel particularly up to constructing their own set in order to be able to transmit on UHF. The 70 cm band is not nearly as crowded as the 2 metre band and its few occupants therefore very enthusiastically welcome newcomers to their midst. Everyone is very keen to offer their help, which is of great importance when the transverter receiver section needs to be calibrated.

The 70 cm band plays a significant role in amateur satellite communications. Communications via OSCAR 7 and OSCAR 8 are partly carried out on this band. Although OSCAR 7 is beginning to show signs of age and is likely to give up the ghost in the near future, a replacement is probably already being prepared for launch. In any case, several geostatic satellites are due to be launched for amateur purposes as well and these will also operate on the 70 cm band. Such satellites (like the TV satellites to be launched shortly) are immobile with respect to the earth's surface and so they cover a certain fixed area of the globe. As opposed to their amateur counterparts, geostatic satellites have the advantage that they can provide contact between, say, the United States and Europe 24 hours a day (provided, of course, they are 'suspended' somewhere above the Atlantic Ocean). In other words, the 70 cm band is ideal for the radio amateur!

### The tripler

The first tentative steps on the 70 cm band are usually taken with the aid of a so-called tripler circuit. A tripler literally trebles the frequency of the input signal. As part of the 70 cm is exactly three times the 2 metre (144...146 MHz) band, a tripler will enable signals to be produced on 432...438 MHz by using an existing set.

However, there are a few drawbacks involved. Firstly, the tripler is only

suitable for use on the transmitter section and so a separate converter will have to be added for reception. Secondly, the tripler can only be used on FM (Frequency Modulation) or CW (Carrier Wave) transmissions and, to make matters worse, it features a rather large power reduction (about 70%). Supplying a tripler with 10 W will therefore give an output in the region of 3 W. Even though 3 W is quite powerful on the 70 cm band, it does mean the tripler has very limited modulation characteristics.

If amplitude modulated (AM) signals are to be transmitted, this also includes single sideband (SSB), the transmitter will have to operate linearly. The tripler can only manage to do this within a very limited range, so that AM signals become very distorted. A clean signal can be obtained by utilising a more refined method.

### The transverter

By using the available 2 m transmission signal and the 70 cm reception signal, transverters mix the different frequencies to obtain the desired finished product. In every 'mixing process' one signal is multiplied by another. As a result, both 'sum' and 'difference' frequencies are produced. Sometimes the original frequencies will also be present in the output signal. Filters are then used to ensure that only one of the required products (sum or difference frequency) is finally passed to the aerial.

Figure 1 shows the block diagram. In the transmit mode the signal is converted from frequency  $f_1$  to frequency  $f_2$ . In the receive mode, on the other hand,  $f_2$  is converted into  $f_1$ . Obviously the easiest answer is to let the transmission converter act as the receiver converter as well. This is not possible in practice, but if a single mixing frequency is used the two converter sections will have quite a lot in common (a frequency of 288 MHz is used in the transverter described here). The communal section will then consist of the 288 MHz oscillator.

Figure 2 shows the block diagram of this type of transverter. In the transmit mode 288 MHz is added to the transmission frequency (144...146 MHz), so that the resultant output frequency will be in the range of 432...434 MHz. When the set is on 'receive' it is the difference frequency that is fed to the 2 m receiver. The 288 MHz signal is subtracted from the received 432...434 MHz input so that the required 144...146 MHz is left. Theoretically, the system should work quite nicely and it would seem ludicrous to select any other type. Unfortunately, a number of problems are involved in practice. As a result of the non-linear characteristics, not only are the frequencies already mentioned produced,

Table 1.

Frequency Spectrum (430-440 MHz)

	430.000		
	431.025	U69	RTTY relay
	431.050	U70	
	431.100	U72	
	431.150	U74	
	431.200	U76	
Input frequencies (FM) relay (7.6 MHz shift)	431.250	U78	
	431.300	U80	
	431.350	U82	
	431.400	U84	
	431.450	U86	
	432.000		432.000 EME
			432.010
			432.050 CW call-up frequency
			432.100 CW Random Meteor scatter
			432.125 OSCAR 7 UP-link mode B
			432.175
			432.200 SSB-Random Meteorscatter
			432.300 SSB call-up frequency
	432.500		432.500 SSTV call-up frequency
			432.600 RTTY-DX
			432.700 FAX call-up frequency
			± 432.900 Buoys
	433.000	RU0	
	433.025	RU1	
	433.050	RU2	
	433.075	RU3	
	433.100	RU4	
	433.125	RU5	
	433.150	RU6	
	433.175	RU7	
	433.200	RU8	
	433.225	RU9	
	433.250		433.250 ATV sound (6 MHz system)
	433.300		433.300 RTTY local
	433.400	SU16	
	433.425	SU17	
	433.450	SU18	
	433.475	SU19	
	433.500	SU20	433.500 (Mobile) international call-up frequency
	433.525	SU21	
	433.550	SU22	433.550 mobile international operating frequency
	433.575	SU23	
	433.750		433.750 ATV sound (5.5 MHz system)
	434.600	RU0	
	434.625	RU1	
	434.650	RU2	
	434.675	RU3	
	434.700	RU4	
	434.725	RU5	
	434.750	RU6	
	434.775	RU7	
	434.800	RU8	
	434.825	RU9	
	435.000		435.100 - 435.200 output range (link) OSCAR 8 mode J
	438.000		
	438.600	U68	
	438.625	U69	
	438.650	U70	
	438.700	U72	
	438.750	U74	
	438.800	U76	
	438.850	U78	
	438.900	U80	
	438.950	U82	
	439.000	U84	
	439.050	U86	
	439.250		439.250 ATV frequency
	440.000		

but also so are a number of unwanted harmonics.

Photo 1 shows the signal spectrum of a transverter constructed according to the block diagram in figure 2. The input frequency here is 144.5 MHz, but because 287.5 instead of 288 MHz was mixed with the signal, the output product will appear on 432 MHz exactly. A similar situation occurs when a 144.75 input frequency is added to a frequency of 288 MHz (find out for yourselves). The undesirable products shown in the photograph consist of the harmonics of the 287.5 MHz signal and the third harmonics of the 2 metre input signal. The lower the difference frequency of the signals, the less distance there is between the mixed products. This means this type of transverter can be heard at no less than ten different points on the 70 cm band wave! That is something you could perhaps live with, but, as the photo shows, the side products sometimes exceed the authorised 70 cm band as well.

When such products do in fact exceed the permissible range, they can be attenuated to a certain extent with the use of filters and the selectivity of the linear amplifier connected behind them. Obviously, however, not many benefits can be expected to be derived from this type of transverter.

The whole problem can be avoided by choosing another system, the principle of which is shown in figure 3. The output signal of the 2 metre transmitter is first divided to give a lower frequency, corresponding to the 10 metre amateur band, and then it is converted to the required frequency, which of course is the 70 cm band. This conversion is not required for the receiver section. The difficulties we have referred to just do not occur in reception. A receiver converter with a mixer frequency of 288 MHz provides very reasonable quality. In practice, the output signal of the 2 m transceiver is mixed with a 116 MHz oscillator signal.

The difference frequency 28...30 MHz (10 metre band) is then mixed with 404 MHz. The result is an output frequency of 432...434 MHz. The difference frequency of the two oscillators (404-116) is 288 MHz, so that an IF is now available for the receiver converter.

Nevertheless, even this system has its drawbacks. To start with, the 15th harmonics of the 10 metre band cover the 420...450 MHz range and this includes the 70 cm-wave band. Furthermore, it is very difficult to suppress image interference properly. In the 288 MHz to 432 MHz conversion image interference frequencies affect the 374...376 MHz range, in other words at barely 56 MHz from the output signal. This means a fairly steep filter is necessary. However, this system has the advantage that the crystal required for the 10 metre wave band is readily available, so that reception is possible.

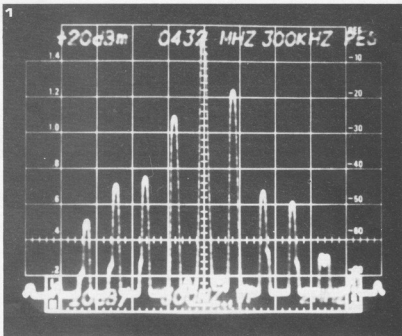

Photo 1. The frequency spectrum of the straightforward transverter shown in figure 2. Scale division: vertical = 10 dBm/division, horizontal = 2 MHz/division. The largest of the unwanted signals is only 20 dBm (= 100 mW) below the one required.

3

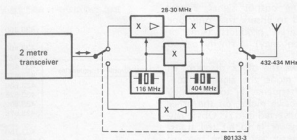

Figure 3. A block diagram of a transverter that uses the 10 metre band as an IF frequency for the transmitter section. The receiver operates by mixing the difference frequency of 404 MHz - 116 MHz = 288 MHz with the incoming 70 cm signal to produce the required 2 metre band output signal.

4

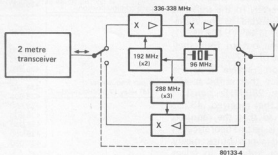

Figure 4. The block diagram of a transverter that uses an IF frequency of 336...338 MHz. Here again the receiver converts directly to the 2 metre band.

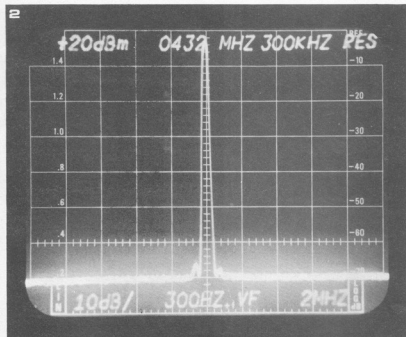

Photo 2. The frequency spectrum of the transverter described in this article. This covers the same frequency range as the one shown in photo 1. The entire waveband is now 'clean' and all undesired signals are attenuated by at least 64 dB.

If you decide on an additional mix frequency, you can always use a different IF, above 30 MHz for instance. The system in figure 4 gives an example of a transverter with a 'high IF'. Use is made of a 96 MHz oscillator frequency, which is doubled (192 MHz) and is then mixed with the 2 m signal. An IF of 336 MHz... 338 MHz is then created. When 96 MHz is added to this again, you're left with the required 70 cm signal. For reception purposes the 96 MHz signal can be tripled, which again leads to the very useful 288 MHz IF.

By mixing the signals twice, any problems with the third harmonics of the 2 metre signal are reduced considerably

and are nothing like as serious as when the frequency is directly mixed with 288 MHz. The system in figure 4 does however have one minor snag. As a simple addition shows, mixing the third harmonics of 192 MHz with 144... 146 MHz produces a differential frequency of 432... 430 MHz. The answer is to use a different crystal frequency. It is advisable to select 57.6 MHz for this, as the fifth harmonic of this frequency again produces the 288 MHz needed for the reception converter/transverter.

Figure 5 shows the slightly modified block diagram. Apart from the frequencies involved, its structure is virtually the same as the one in figure 4.

5

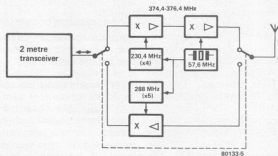

Figure 5. The block diagram of the transverter described in this article. The (transmission) IF ranges from 374.4 MHz to 376.4 MHz.

The fourth harmonic of the crystal oscillator (230.4 MHz) mixed with the 2 m signal gives an IF of 374.4... 376.4 MHz. By mixing another 57.6 MHz with that the required 70 cm signal may be obtained. Against all appearances, the crystal oscillators in figures 4 and 5 are in fact related to each other. At such high frequencies overtone crystals are usually used with a fundamental frequency below 20 MHz. 57.6 and 96 MHz crystals generally feature the same fundamental frequency, this being 19.2 MHz. Thus, a 96 MHz overtone crystal (= 5 x 19.2 MHz) is bound to oscillate equally well at 57.6 (= 3 x 19.2 MHz). The transverter described here works according to the principle shown in the block diagram of figure 5.

This type of transverter also produces undesirable interference within the 70 cm band range and so this has to be filtered out. By using well adjusted mixers, interfering signals can be attenuated and kept at more than 60 dB away from the required signal. This requirement is quite easily met by a signal level of +20 dBm (= 100 mW). The GPO requires transmitters of up to 10 W power to feature 60 dB rejection and those above 10 W to feature not more than 10 microwatts per interfering element. In order to be able to achieve a reasonable level or power a linear output stage should be connected behind the transverter and this improves suppression outside the 70 cm wave band considerably. By choosing a suitable IF and a good design, the spectrum can be 'cleaned up' fairly well. Even though this cannot be measured without the use of a spectrum analyser it can be done. The circuit is calibrated by adjusting a few test points to maximum deflection on a meter. It is virtually impossible to calibrate the circuit to a minimum of interference without using professional equipment. However, as we will see later, the circuit can be calibrated in such a manner that the best result is obtained almost automatically. Photo 2 shows the frequency spectrum of the transverter described here. Clearly it is very different from the one in photo 1.

### The crystal oscillator

The crystal oscillator (see figure 6) together with the associated circuitry produces signals to convert the 70 cm wave band (or at least the 432... 434 MHz section) to the 2 metre wave band (144... 146 MHz) during reception and vice versa. The crystal is connected to the base of T1 and to the junction of C1 and C3, a capacitive divider. The collector circuit (L1, C3 and C1) is tuned to 57.6 MHz so that the crystal will oscillate at the third harmonic of 19.2 MHz.

A voltage stabiliser IC (IC1) has been added to prevent any fluctuations in

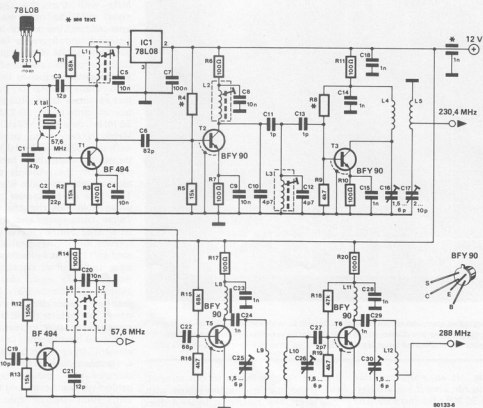

Figure 6. The circuit diagram of the crystal oscillator section including the frequency multipliers.

the power supply voltage from affecting the circuit. Transistors T2, T4 and T5 are provided with the 57.6 MHz signal by way of capacitors C6, C19 and C22, respectively.

A 288 MHz signal is required for conversion during reception. Transistor T5 therefore multiplies the crystal oscillator frequency by five. Since the 5th harmonic at the collector of T5 is relatively weak, an additional amplifier stage has been connected behind it which is inductively coupled by coils L9 and L10. The transistors used are the BFY 90 type and amplify so well on 288 MHz that the output (L12) ends up supplying between 5 and 10 mW of power. Part of this may be used as a master oscillator in a multiplier chain (4x) and eventually give rise to a signal on 1152 MHz. This serves to create a transverter for the 23 cm wave band (1296...1298). The placing of the 'tap' on L12 depends on what the circuit is used for. If the output is to be connected to several circuits it is best to position the tap near to ground. If only the reception mixer is to be connected, the tap should be placed in the centre of the coil. The coil will

then be under a fairly heavy voltage, but at least the circuit will be less likely to oscillate.

If in spite of these measures the circuit starts to oscillate, this can be suppressed by connecting a resistor in series with either C24 and/or C29. A value of 100  $\Omega$  should usually be enough, but it is better to take a smaller value, as the chances are that a lot of output power will be lost. As it happens, there was no need to connect a resistor to any of the three tested prototypes.

The transmitter features two conversions. First 144 MHz is mixed with 230.4 MHz (= 4 x 57.6 MHz) to produce 374.4 MHz and then this is converted into 432 MHz by mixing in another 57.6 MHz. Obviously, the sum of the mixing frequencies will once again be 288 MHz.

The 230.4 MHz signal is produced by doubling the oscillator signal twice. The frequency is first doubled by transistor T2. A critically coupled band pass filter is connected to the collector of T2 (via C11) and this is tuned to 115.2 MHz (twice the frequency of the oscillator signal). When T3 doubles the frequency again, the required 230.4

MHz signal will finally be available at the output of the band pass filter made up of L4, L5, C16 and C17.

The 57.6 MHz signal which also plays a part in transmission is not derived directly from the crystal oscillator but is first amplified and filtered by transistor T4. The coupling coil (L7) ensures that the signal (about 10 mW here) has a low impedance.

### The reception converter

Before a transverter can be put to full use, the reception unit needs to meet a few requirements:

- It should feature low noise.
- A fair amount of gain, about 10 x (20 dB). More gain than this would only create havoc, such as intermodulation, jamming, etc., in the receiver connected to the set. On the other hand, if the gain were too low the receiver's contribution to the total noise factor would be too high.
- The set must suppress image interference. This depends entirely on the selectivity of the filters in the receiver

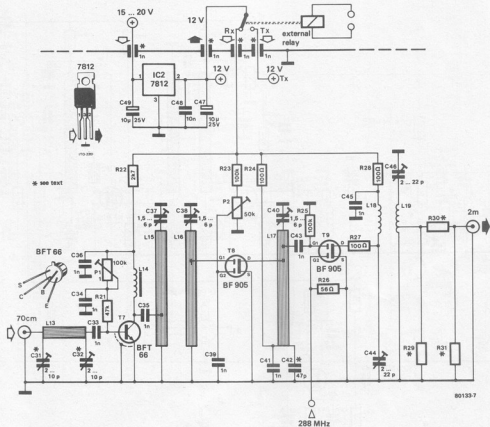

Figure 7. The circuit diagram of the receiver converter. The integrated strip-line inductors provide excellent input selectivity.

front end. For signals on image frequencies (2 metre band!!) to be reduced to a minimum, they will have to be attenuated by more than 60 dB.

Low noise is exactly what the BFT 66 has to offer and this transistor is therefore included in the circuit (see figure 7). The filter consisting of C31, C32 and L13 make sure the aerial (50... 75 Ω) is properly adjusted to the input impedance of the transistor (T7). Photo 3 clearly illustrates how the filter is structured. In this case 'trimmer' capacitors have been used, but it is also possible to use ordinary foil capacitors. After being amplified by T7 the signal is filtered via L15 and L16, C37 and C38 (strip-line band pass filter) and is then further amplified by the MOSFET T8.

Transistor T7 receives its collector (DC) current from the RF suppression choke L14. This enables the band pass filter to operate without a DC voltage, which is much better. MOSFET T2 is connected as a mixer. The output signal is filtered by the band pass filter L18, C44, L19 and C46, so that only the required conversion product remains at the output (144... 146 MHz).

3

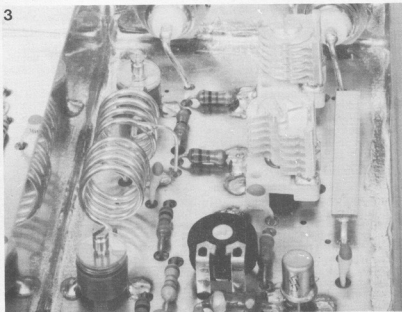

Photo 3. A detailed view of the receiver converter section. The strip-line inductor in the input filter is the only one of this type to be mounted on the board rather than being etched out of the copper laminate.

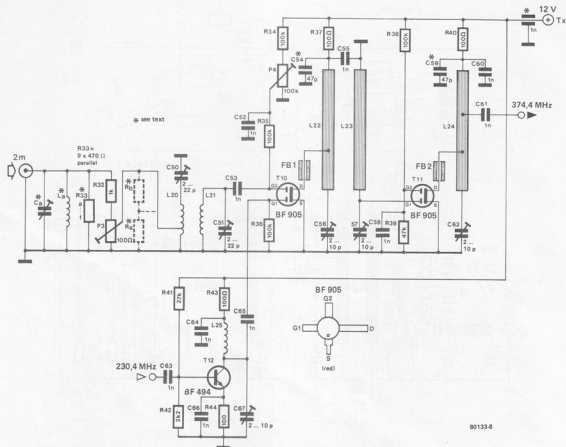

Figure 8. The 'front end' of the transmission converter including the dummy load. If necessary, an additional attenuator can be connected to the wiper of P3 (Ra and Rb), enabling the control circuit to be properly adjusted even if the input power is higher than 10 W.

As a result of the amplification the signal strength meter in the 2 m transmitter will indicate a level that is 20 dB too high. To compensate for this difference in signal level another attenuation network can be connected after the output band pass filter. This reduces part of the excess output signal. It has the added advantage that the receiver is provided with an almost optimum load at its aerial input.

### The transmission converter

The 144...146 MHz transmission signal is converted to a frequency of 432...434 MHz with the aid of two converters. The first converter mixes the signal to produce an IF of 374.4...376.4 MHz (see figure 8). The circuit is supplied with a dummy load (R33) to avoid having to modify the existing transmitter. This resistor converts most of the incoming power into heat. The input power using the values here should not be more than 10 W (the impedance is about 50  $\Omega$ ).

Photo 4 shows the dummy load which has been incorporated inside a separate

compartment to prevent interference from the 2 metre band signal. The printed circuit board also allows the dummy load to be adjusted with the aid of a parallel tuned circuit and so obtain an optimum Standing Wave Ratio (SWR). Using the parallel inductor (3 turns) on the photo the SWR was found to be better than 1.1:1. Where the inductor is placed on the board is a rather critical matter. It is not, for instance, a good idea to solder it directly to the BNC connector. In the prototype a parallel trimming capacitor was not needed.

After the dummy load 10% of the input power is fed to the mixer (T10). If the input power is 10 W, this would be too much, but P3 can be used to attenuate it further. It is not possible to reduce the power completely due to slight interference. In practice, P3 produces an adjustable range of 10...15 dB, depending on the quality of the screening. More details on this subject will be given in a subsequent chapter on construction and calibration.

A band pass filter consisting of L20, C50, L21 and C51 again ensures that as much interference and noise as possible

is suppressed so that the  $g_2$  electrode of the mixer FET T10 receives as clean a signal as possible. Transistor T12 amplifies and filters the 230.4 MHz signal derived from the oscillator board before this is fed to  $g_1$  of T10. The mixer products are filtered by L22, C56, L23 and C57 and the resultant 374.4...376.4 MHz signal is further amplified by transistor T11.

In the final section of the transverter the 374.4...376.4 MHz signal is once again mixed with the oscillator frequency of 57.6 MHz. This produces the required frequencies of 432...434 MHz. This 70 cm signal is again filtered and amplified to a level of about 50 mW, which is adequate to drive most output stages without any difficulty.

The circuit diagram of the output section of the transverter is shown in figure 9. Inductor L26 and capacitor C68 constitute a tuned input circuit operating at a frequency of 374.4...376.4 MHz. The input impedance is about 50  $\Omega$  so that this particular circuit can be connected to the first transverter mixer board by a 'normal' piece of screened cable, or even by means of a wire link in view of the



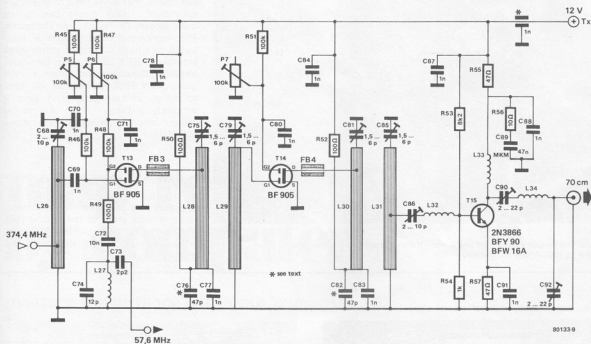

Figure 9. The circuit diagram of the output stages of the transmission converter. Again, integrated strip-line inductors have been incorporated wherever possible.

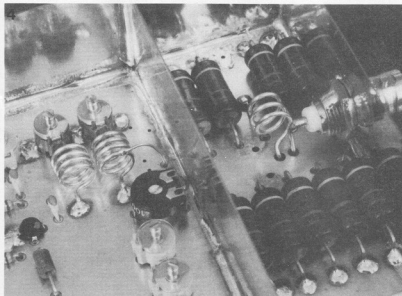

Photo 4. A close-up of the dummy load. The nine resistors involved can easily cope with an input power of 10 W during SSB operation. During AM and FM operation, however, the circuit can get rather warm. The inductor provides an optimum SWR (Standing Wave Ratio) - about 1.1:1 in the prototype.

very short distance between the two boards. Exactly how this can be accomplished will be fully explained in the subsequent article on construction and calibration.

The input power here is about 1 mW, which is more than enough. More power than this would only cause a great deal of interference. However, the mixer MOSFET, T13, requires a little more power at its second gate ( $g_2$ ). This is connected to the output of the 57.6 MHz section via capacitor C73. The amount of power available at this point is around 10 mW.

The band pass filter consisting of L28, C75, L29 and C79 forms the first 70 cm section of the circuit at the drain of T13. The signal is then amplified by T14 before being fed by way of another band pass filter (L30, C81, L31 and C85) to the output stage.

The output stage (T15) can (only) produce about 50 mW rf power. It may be possible to get a little more out of it, but this could affect the linearity and noise suppression of the circuit. If the circuit is calibrated as indicated (see subsequent article) it should operate correctly with no problems whatsoever.

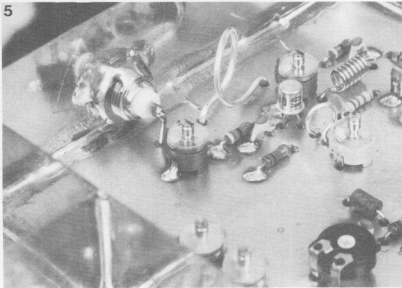

Photo 5. The output stage of the transverter. Various types of transistor may be used, such as the BFY 90 shown here for instance.

Various types of transistor may be used in the output section without having to alter the values of any other components. The following types have been tested successfully: BFY 90, 2N 3866, BFW 16A and BFR 96. The last one in that series has a different pin assignment, which means that is not quite so easy to mount it on the board. The completed output stage is illustrated in photo 5. This is constructed around a BFY 50 in this particular instance. If readers can obtain a good quality 2N 3866 (tolerances do tend to differ, so take care), this type is definitely a better choice due to its greater attenuation of signals above 500 MHz.

### Construction and calibration

A detailed description of the construction and calibration of the transverter will be given in the second part of this article. This will include the printed circuit boards shown in the photographs in this issue. **M**

10

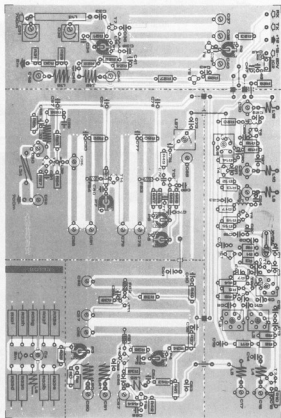
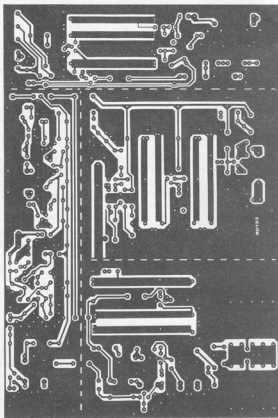

Figure 10. Just to give an idea of what the (double-sided!) p.c. board will look like . . . In the second part of this article the board will be given full-size.

# map reading by computer

## measure the distance with your computer

Personal computer owners are always on the look-out for new applications, new 'tricks' they can teach their electronic pets. This article describes a small but powerful sensor which enables distances between two points on a map to be measured with a fair degree of accuracy. A computer program then converts the number of centimetres measured into the actual distance in kilometres.

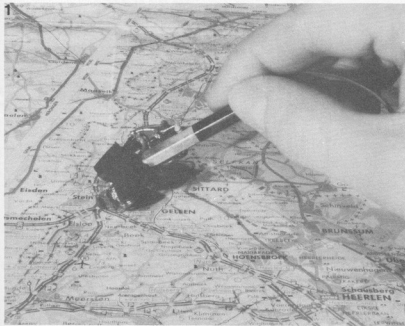

Photo 1. An alternative solution towards constructing the sensor. This does not operate on the light interruption principle, but uses the light reflected by the black-and-white squares. That is why this particular sensor must be 'light-proof'.

With the ever increasing cost of motoring, the driver tends to keep close track of his car's mileage and, if possible, reduce the distance to be travelled down to an absolute minimum. Holiday makers, in particular, need to know the exact (and shortest) distance from one place to another, so that they do not end up stranded in the middle of nowhere with an empty petrol tank. Usually, a map is spread out on a table and the number of centimetres from A to B is measured with a ruler and then converted into kilometres according to the scale of the map.

The calculation involved is really quite straightforward, but if the route is full of twists and turns it is very easy to miss out or add on a couple of centimetres, so why not let the computer take the problem off our hands? Instead of the ruler, a sensor is attached to a tiny wheel and is rolled along the intended route on the map. The distance it covers is transformed into a series of pulses which are counted by the computer thereby enabling it to calculate the actual distance in kilometres.

### The sensor

As can be gathered from the above paragraph, the vital element in the system is the sensor. This ensures that the number of centimetres to be measured is converted into a corresponding number of pulses which are then processed by the computer.

Operation is as follows. On the front of the sensor there is a small wheel which can turn freely. At certain points slots have been cut into the wheel. On one side of it there is a lamp and on the other side there is a photo transistor. Every time the wheel turns round, the photo transistor is illuminated for a split second by the lamp through one of the slots that passes between them. During that split second the transistor and the lamp can 'see' each other, so to speak, and so the transistor will start to conduct. If the wheel carries on turning, the light beam will be interrupted and the transistor will stop conducting until another slot appears. Depending on the number of slots in the wheel, the photo transistor will emit a certain quantity of pulses per revolution.

The pulses generated by the photo transistor are fed to a Schmitt trigger which is constructed around IC1. This produces a signal that is TTL-compatible and is in turn fed to the computer. Figure 1 shows the sensor circuit diagram.

To simplify the mechanical job as much as possible, a printed circuit board has been designed for the sensor (figure 2) and this also contains the wheel. The latter section can be cut out and the wheel can be filed into shape. After this, slots are cut in the places indicated on the wheel. In addition, a hole is made in the middle to allow the axle to be inserted.

1

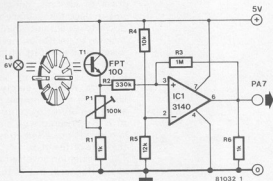

Figure 1. The sensor circuit diagram. A Schmitt trigger converts the light beam interruption into a TTL-compatible signal.

2

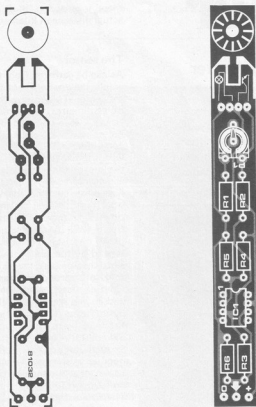

Figure 2. The printed circuit board and component overlay for the sensor.

#### Parts list

##### Resistors:

R1, R6 = 1 k  
R2 = 330 k  
R3 = 1 M  
R4 = 10 k  
R5 = 2 k  
P1 = 100 k preset

##### Semiconductors:

T1 = photo transistor, e.g. FPT 100.  
If the sensor is based on the reflection principle, it is better to use a photo darlington type (e.g. 2N5777 Motorola)  
IC1 = 3140

##### Miscellaneous:

La = miniature light bulb 6 V

The component board is now provided with a slightly wider slot at one end. This is where the wheel is to be mounted. A piece of wire may be used as the axle which is inserted through the hole in the middle of the wheel. The wheel is then fitted to the printed circuit board and the axle is soldered on both sides of the board. After this, the components may be mounted on the board. The lamp and the photo transistor should be positioned with care. Another view of the sensor is given in the drawing in figure 3.

The supply voltage is now connected up and preset P1 is adjusted until the output voltage at pin 6 of IC1 alternates between logic one and logic zero when the wheel is turned slowly.

The printed circuit board is small enough to be inserted inside a plastic tube. Of course, what we have just described is just a suggestion and there are various other ways in which to construct the mechanical section of the circuit. The home-made wheel described above is fairly thick and therefore not always very accurate when the route on the map follows twists and turns, or when 'distances' of a few millimetres are involved. An ideal solution in this respect would be to use part of the workings of an old (mechanical) watch. Figure 4 shows how to go about the construction. Since reflection plays an important part in the circuit's operation, make sure that this part of the sensor is as 'light proof' as possible. The finished product is shown in the photograph.

#### The software

Once the mechanical section has been taken care of, a program will have to be written to take care of the calculation work. In principle, the sensor can be connected to any computer that is provided with a port connector. The following description refers to the flow chart which allows a suitable program to be written in any programming language required. The example used here was written specifically for the Junior Computer and is listed at the end of this article.

Figure 5 shows the basic flow chart of the mapping program. The computer starts at subroutine INITS. This makes sure that the correct initial information is stored in the data buffers. In addition, the EDET register is addressed once, so that the flag of the port input to which the sensor is connected (the PA7 flag in the Junior Computer) is set when there is a positive edge at this input. This is required to detect the subsequent input pulses that are generated by the sensor. After subroutine INITS the main routine is continued from the label SCAFAC.

Provided the plus (+) key is not depressed at this stage, the program will now enter a wait loop and will keep returning to the SCAFAC label. During the loop the number of pulses emitted

3

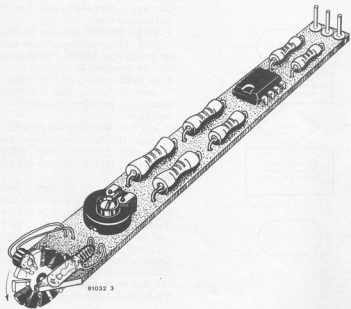

Figure 3. This is what the mounted sensor should look like. The photo transistor can best be painted black apart from a small area on the light-sensitive side.

4

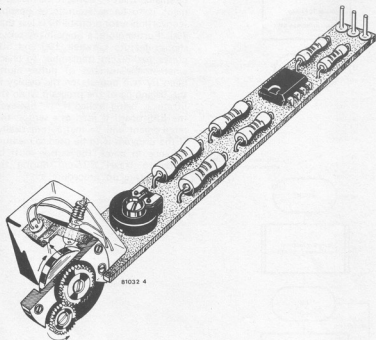

Figure 4. A home-made sensor prototype. It was made from the bits and pieces of an old watch.

by the sensor is counted. The sensor must now cover a distance of exactly 50 cm. The pulse count is multiplied by two and the result is shown on the display. The display will therefore show how many pulses were counted per metre. This number is of vital importance for the rest of the program, since it indicates the conversion factor: distance-pulses. If the plus key is depressed

during the wait loop the loop is left and the computer checks whether pulses were counted during the preceding program section, or not. If so, the program jumps straight to TRSFER. If not, the operator has the opportunity of keying in the number of pulses per metre manually at this point. This is done during the KEYSEL subroutine. The program is structured so that the

sensor only has to cover 50 cm once. The number will then be known and so the next time that it is needed it can be keyed in by the operator, which saves a lot of time.

The number is now stored in memory locations (SCALE(B...D) and is subsequently moved to SCAF(A...C). Locations SCALE(B...D) are now vacant and can be used to store the scale. The scale is again entered during KEYSEC. After entering the scale and then depressing the plus key, the scale is checked to see whether it is equal to or smaller than 99999. If this is the case, the count is updated in metres on all six displays. If, on the other hand, a larger scale is used, the first four displays keep track of the count in kilometres.

At this stage in the program, the computer is in for a 'real' piece of calculation work. Subroutine DIVDEC is called and the entered scale (SCALE) is divided by the number of pulses per metre (SCAF). The result of the division, which is carried out in decimal, is stored at locations KM(A...D). This figure indicates the distance between two sensor pulses, expressed in terms of the entered scale. That covers most of the computing work. Now the display is cleared and the computer can concentrate on the actual measurement involved.

This brings us (and the machine!) to the program loop CO. This adds the figure stored at memory locations KM(A...D) to the figure indicated on the display, whenever a pulse is generated by the sensor. The result represents the actual distance to be travelled, provided, of course, the same route is taken as shown on the map.

### The listing

Figure 6 gives the listing for the program as written for the Junior Computer. Now that the flow chart has been dealt with in detail, the program should be easy to follow.

As can be seen, the program runs from address 0200 to 0329. It only needs to be typed in once, after which it can be stored on cassette and can be loaded into the machine whenever required. Alternatively, the program may be stored in (E)PROM, but then the absolute jump addresses and the NMI vector will have to be adjusted to the address range where the PROM is located.

### How to work with the program

Once the program has been typed in and the sensor has been connected to the port connector (+5 V, GND and PA7), the program can be started. Provided no typing errors were made, 000000 will appear on the display. Now the sensor is made to cover 50 cm and the figure that appears on the display is noted for another occasion. After this, the plus key is depressed and

5

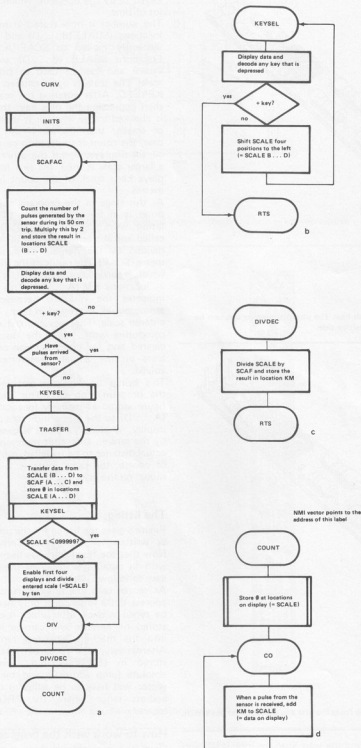

Figure 5. The flow chart of the program.

000000 appears on the display. The map's scale may now be entered and the plus key is depressed again. Two things can happen now:

- either 000000 appears on the display. The entered scale was equal to or smaller than 99999. The distance will then be measured in metres.

- or 00000 appears on the display. The scale was greater than 99999 and the distance is therefore measured in kilometres.

If you have finished measuring but wish to take another measurement on the same map (starting from 0000 (00) again), depress the NMI key and off you go!

The next time the program is used the sensor does not have to cover another 50 cm, as the number of pulses for that distance is already known... that is, if you remembered to write it down! Then the plus key is depressed, the pulse figure is entered and the plus key is depressed again. Now the scale is keyed in, the plus key is pressed yet again and the computer is 'ready to measure'.

### At the end of the road . . .

Just a few final remarks to get you on your way. The entered scale should not be smaller than 1 : 2500, if the measurement is to be as accurate as possible (conversion error probability is less than 1%). Furthermore, a home-made sensor should feature between 100 and 500 pulses per 50 cm (remember to check whether the number of pulses multiplied by two appears on the display at the beginning of the program when the 50 cm is being 'rolled'). If, however, the EPS board is used as a sensor, this requirement will be met automatically. If the program is to be used to measure distance in *miles*, the sensor must be made to travel *80.5 cm* during the initial 'setting up' procedure. ■



```

TEMPORARY DATA BUFFERS
0200 NEM1  * S0NE5
0200 NEM2  * S0NE7
0200 RES3  * S0NE9
0200 RES4  * S0NE9
0200 RES5  * S0NE9
0200 RES6  * S0NEA
0200 RES7  * S0NEB
0200 ADEL  * S0NEC
0200 ADDR  * S0NEE
0200 SCAPA * S0NEE
0200 SCAPB * S0NEF
0200 SCAPC * S0NEF
0200 SCAPD * S0NEF
0200 IMA   * S0NF3
0200 IMA  * S0NF3
0200 IMA  * S0NF3
0200 IMA  * S0NF4
0200 IMA  * S0NF5
0200 IMA  * S0NF6
0200 IMA  * S0NF7
0200 SCALZA * S0NFB
0200 SCALB * S0NFB
0200 SCALC * S0NFB
0200 SCALD * S0NFB
0200 SCALZ * S0NFB

NM1 VECTOR
0200 NM1L  * S1ATB
0200 NM1R  * S1ATB

WRITE EDGE DETECT CONTROL
0200 SETH  * S1AES FOR RESET DISABLE PA7-IRQ

READ FLAG REGISTER AND CLEAR TIMER & IRQ FLAG
0200 NOFLAG * S1ADS BIT# = PA7-FLAG

EXTERNAL SUBROUTINES
0200 SCANE * S1DSE
0200 GETKEY * S1DFF

*****
MAIN PROGRAM
*****

0208 20 83 #3  CBN  JSR  INITS
0209 A9 F9      SCAPC LDXM SCALZ
0209 85 E5      STAX NML
0209 A9 E8      LDXM R5SA
0209 85 EC      STAX ADEL
0209 20 8F #2  JSR  ANMULS TEST PA7-FLAG; IF SET, INCREMENT
                   SCALE BY TWO
0209 20 FA #2  JSR  KI   DISPLAY DATA; IF KEY DERESSED, DEBOUNCE IT
                   BND  SCAPC KEY RELEASED?
0211 20 F9 3D  JSR  GETKEY DECODE KEY, RETURN WITH VALUE IN ACC.
0212 C9 12      CMPIR #12
0212 D8 E9      BNE  SCAPC PLUS KEY?
0214 A3 FA      LDWZ SCALZC PULSES COUNTED?
0212 D8 #3      BNE  TRAPFR
0218 20 56 #2  JSR  KEYSEL DISPLAY KEYS-IN DATA

0221 A3 #2     TRAPFR LDXM #82

0223 85 F9     TRA  LDXM SCALER TRANSFER DATA FROM SCALE TO SCAP
0225 95 E8     STAX SCAPA
0227 CA      SXR
0228 10 F9     BRL  TRA
0228 20 1A #3  JSR  INITSA
0228 20 56 #2  JSR  KEYSEL
0230 A9 09     LDXM #89
0232 C5 F9     CMPIR SCALZD IS SCALE LESS-EQUAL #99999?
0234 88 09     BCS  DIV
0236 C4 F6     DECB BYTES ENABLE FIRST FOUR DISPLAYS
0238 A3 F8     LDXM SCALZA
0238 A4 #4     LDXM SCA
023C 20 E8 #2  JSR  DRIFTR DIVIDE SCALE BY 10

023F 20 87 #2  DIV  JSR  DIVSEC

0242 20 1A #3  COMPT JSR  INITSA

0245 A9 F8     CO  LDXM SCALZA
0247 85 E6     STAX NML
0249 A9 F2     LDXM IMA
0248 85 EC     STAX ADEL
0240 20 8F #2  JSR  ANMULS
0250 20 8E 1D  JSR  SCANE
0253 4C 45 #2  JMP  CO

*****
SUBROUTINES
*****

0256 20 EC #2  KEYSEL JSR  KEYIND DISPLAY DATA, RETURN WITH KEY-VALUE
0259 C9 12      CMPIR #12 PLUS KEY?
0259 F8 20     BND  RPN
025D C9 0A      CMPIR #A ILLEGAL KEY?
025D 1F F5     BRL  KEYSEL
0261 A3 F5     LDXM SCALZB
0263 88 04     LDWZ SCA
0265 20 C4 #2  JSR  DRIFPL SCALE 4 POSITIONS TO LEFT
0268 85 F9     STAX SCALZB
026A 85 F9     STAX SCALZB STORE KEY-VALUE INTO LOWER NIBBLE
                   OF SCALER
026C 4C 56 #2  JMP  KEYSEL

026F AD D5 1A  ANMULS LDXM NOFLAG
0272 0A      ALIA
0273 10 11     BRL  RPN 15 PA7-FLAG RESET?
0275 10      CLC

0276 F0      SED
0277 A8 #0    LDXM #88

ADD  LDXM NML  ADD DATA SPECIFIED BY ADL(IND Y)
         TO DATA SPECIFIED BY NML(IND Y)
0279 81 E6    ADD  ADLX ADL
0279 71 EC    ADDX ADL
027D 91 E6    STAX NML
027F CA      LDXM #C
0280 90      TRA
0281 49 04    LDXM SCA
0283 D8 F4    BNE  ADD Y LESS EQUAL 3?
0285 D8      CLD

0286 60      RPN  RTS

0287 A9 #0    DIVSEC LDXM #88
0289 85 F7    STAX SCA

028A A9 F0    SETB LDXM SFB
028D 25 F1    ANDX SCAPD IS LEFT NIBBLE OF SCAPD NOT EQUAL ZERO?
028F D8 00    BNE  SUBTR
0291 A3 E6    LDXM SCAPA
0293 A8 04    LDXM SCA
0295 20 C4 #2 JSR  DRIFPL SCAP 4 POSITIONS TO LEFT
0298 E6 F7    LDCX TEMP
029A 10 82    BPL  SETB BRANCH ALWAYS

029C A3 #0    SUBTR LDXM #88
029E 20 D8 #2 JSR  SUBSEC SUBTRACT DECIMAL SCAP FROM SCALE AND
                   STORE RESULT AT RES
02A1 90 8D    BCC  SETB RES NEGATIVE?
02A3 10 F2    LDCX #8A INCREMENT IN BY 1
02A5 A3 #3    LDXM #3

02A7 85 E8    TRANSF LDXM RESA
02A9 95 F8    STAX SCALZA TRANSFER DATA FROM RES TO SCALE
02AB CA      LDXM #A
02AC 10 F9    BPL  TRANSF
02AE 10 EC    BPL  SUBTR BRANCH ALWAYS

02B0 C6 F7    SUBTR DECB TEMP
02B1 8D 82    BND  RPN
02B4 A3 F2    LDXM #FA
02B6 A4 #2    LDXM SCA
02B8 20 C4 #2 JSR  DRIFPL IN 4 POSITIONS TO LEFT
02BA A3 E6    LDXM SCAPA
02BC A4 #4    LDXM SCA
02BE 20 E8 #2 JSR  DRIFPL SCAP 4 POSITIONS TO RIGHT
02C0 F8 D8    BEQ  SUBTR BRANCH ALWAYS

02C4 16 80    DRIFPL ASLXZ #8000
02C6 36 #1    ROLXZ #8001
02C8 36 #2    ROLXZ #8002
02CA 36 #3    ROLXZ #8003
02CC 36 #4    ROLXZ #8004
02CE D0 F5    BNE  DRIFPL
02CF 6A      RTS

02D0 F0      SRTXSEC SEC
02D1 10      SED

02D2 85 F8    SD  LDXM SCALZA SUBTRACT DECIMAL SCAP(IND X) FROM
                   SCALE(IND Y) AND STORE RESULT AT RES
02D4 F5 #0    INDXZ SCAPA
02D6 95 E8    STAXZ RESA
02D8 00      TRX
02D9 0A      TRA
02DA 49 04    LDXM SCA
02DC C4 F4    BNE  SD X LESS EQUAL 3?
02DE D0      CLD
02DF 6A      RTS

02E0 56 #3    DRIFPL LDXM #8003
02E2 76 #2    ROLXZ #8002
02E4 76 #1    ROLXZ #8001
02E6 76 #0    ROLXZ #8000
02E8 00      DEY
02EA D8 F5    BNE  DRIFPL
02EB 6A      RTS

02EC 20 8E 1D  KEYIND JSR  SCANE
02ED D0 F9    BNE  KEYIND KEY DERESSED?

02F1 20 FA #2  KIN  JSR  KI
02F4 F8 F0    BEQ  KIN NO KEY DERESSED?
02F6 F8 F0 3D  JSR  GETKEY
02F9 60      BND  F8

02FA 20 8E 1D  KI   JSR  SCANE
02FD F8 #3    BEQ  KEY NO KEY DERESSED?
02FF 20 8E 1D  JSR  SCANE

0302 60      RET  RTS

0303 A9 #0    INITS LDXM #88
0305 A4 #F    INITS LDXM #FF

0307 95 E6    IN  STAX NML
0309 CA      DEY
030B 10 F0    BPL  IN
030C A0 A2    LDXM COUNT LOAD NM1 VECTOR WITH COUNT-ADDRESS
030E 8D 7A 1A STX  NML
0311 A9 #2    LDXM COUNT /256
0313 8D 7B 1A STX  NMIS
0315 A0 #2    LDXM #82
0318 00 #3    STAX RESA

031A AD D5 1A  INITSA LDXM NOFLAG
031D 8D #5 1A  STX  NMIS
031F A9 #0    LDXM #88
0321 A3 #3    LDCX #83

0324 95 F9    INA  STAXZ SCALZA CLEAR SCALZA
0326 CA      DECA
0327 10 F0    BPL  INA
0329 60      RTS

```

Figure 6. The program listing.

Readers who use oscilloscopes on a regular basis will know how difficult it is to examine a low frequency signal of, say, 10 Hz. Not to mention the problems of checking the degree of relay contact bounce! Either the signals take so long to be written onto the screen that the first portion of the signal has disappeared before the end of it has been displayed (in the case of the 10 Hz signal) therefore it is impossible to obtain a clear view of the overall spectrum. Alternatively, the signal has entirely disappeared before we could get a chance to look at it (contact bounce).

In last month's issue it was seen that a great deal of the required circuitry is in fact already provided in the logic analyser. All that is needed now is to add the two converters and the associate input circuitry and the whole unit can be mounted on a module which can be connected to the main board of the logic analyser.

# storage scope

## first catch your signal . . .

Sometimes it is very useful, if not necessary, to be able to 'freeze' very fast or very slow signals that are to be examined on an oscilloscope screen. For this the oscilloscope will have to be provided with a memory. The solution offered in this article is to use a standard oscilloscope and combine it with the digital memory of the logic analyser (described in last month's issue of Elektor). Included is a circuit which converts the analogue signal into a digital counterpart which can then be stored in the memory. As mentioned last month, the logic analyser main board already caters for the storage scope addition.

Fortunately, there is a solution in the form of a 'memory' scope. This uses a fluorescent screen which allows signals to be observed by 'freezing' them for a relatively long period of time. The concept is similar to what happens when you look up at the sun on a bright day. Close your eyes and you will still 'see' the fiery glare for some time.

However, the 'memory' scope has one disadvantage — the picture gradually deteriorates in quality as time passes. The effect can be compared to a jet flying overhead. Its vapour trail lingers in the sky for a while before fading away.

As far as the storage scope under consideration here is concerned, it is yet another example of digital technology infiltrating into traditionally analogue territory. For here a digital memory in conjunction with an analogue-to-digital (A/D) converter and a digital-to-analogue (D/A) converter plus control circuitry ensure that signals can be permanently displayed (provided, of course, that the power supply is not switched off).

## Screen 'photography'

If you have read the previous articles on the logic analyser, you will have been confronted with enough block diagrams to last you a life time, or at least plenty for this particular application! Without further ado therefore, let us see how the storage scope works by examining the circuit diagram shown in figure 1.

First let us examine the input circuitry shown at the top left-hand corner of figure 1. The analogue input signal enters the circuit at the AC/DC switch S1. While this switch is open any DC in the input signal will be blocked by capacitor C1.

After this, the input signal is attenuated by resistors R1 . . . R5. The sensitivity of the circuit can be selected by switch S2. The signal is then limited by resistor R6 and diodes D1 and D2 before being fed to the buffer amplifier IC1. Potentiometer P1 acts as the variable V/div control of the unit: the signal level at the wiper of P1 is inverted and amplified by opamp A1.

The next opamp, A2, adds the DC voltage present at the wiper of potentiometer P2 (DC shift) to the output signal of A1. This enables the operator to ensure that the input voltage to the A/D converter is positive, as it should be at all times. When the wiper of P2 is in the centre position, about +0.5 V will be added to the signal via the non-inverting input of A2. At the heart of figure 1 is a sample-and-hold circuit which is constructed around an operational transconductance amplifier (OTA) together with transistor T2. In actual fact, the output of the OTA constitutes a voltage controlled current source. The output current depends on both the differential voltage at the input (between pins 2 and 3 of IC5) and on the control current flowing into pin 5 of IC5 (transistor T1 is a PNP device). According to the polarity of the output current, capacitor C10 is either charged or discharged in proportion to the size of the output current independently of any resistance. The presence of the high impedance FET buffer T2 guarantees this. The output of T2 is fed back to the non-inverting input of IC5 (pin 2), so that the voltage at the source of T2 will follow the output voltage of A2 for as long as T1 conducts.

The output of T2 is then fed to the input of the A/D converter (pin 6 of IC3) via resistor R35. The eight data outputs of IC3 are connected directly to the RAM inputs of the logic analyser. Gate N21 in the logic analyser provides

### Technical specifications storage scope

- input sensitivity: 100 mV/div.
- memory: 256 x 8 bit
- sampling time:
  - 25  $\mu$ s . . . 5 ms (internal clock)
  - long without limitations (external clock)
- highest input frequency (component): 2 kHz
- functions: — AC/DC
  - V/div.
  - V/variable
  - DC-shift
  - trigger level
  - trig+ or trig-



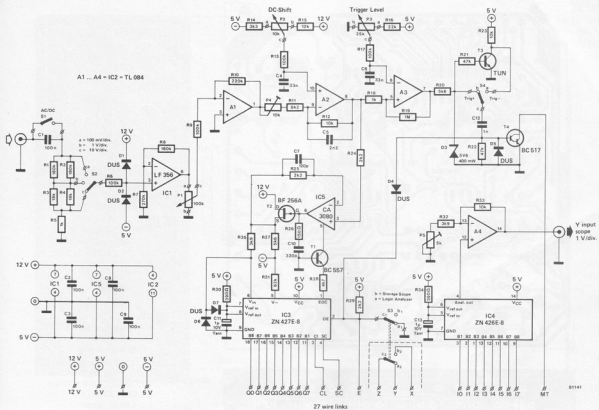

Figure 1. The circuit diagram which, in combination with the logic analyser, converts an ordinary oscilloscope into a storage scope.

the circuit with a 2.5  $\mu$ s or 5  $\mu$ s clock signal (CL) and gate N17 produces start pulses for the SC (Start Conversion) input. Switch S3 has been included to allow the operator to select between the storage scope and the logic analyser. When the output enable (OE) is connected to ground, the data outputs of IC3 are effectively disconnected from the RAM and the logic analyser can be operated as normal.

During the actual conversion from analogue (pin 6 of IC3) to digital (pins 12...18 of IC3) the end of conversion output (EOC) will be logic zero. This means that T1 will not conduct and that the sample-and-hold circuit mentioned earlier will be in the hold state. At the end of the conversion, EOC will change to logic one, causing T1 to conduct and the sample-and-hold circuit to enter the sample state.

Part of the signal at the output of A2 is fed to the sample-and-hold circuit via R24, and part to the Schmitt trigger formed by A3. The voltage level at which the Schmitt trigger operates can be adjusted by means of potentiometer P3. The output of A3 has the purpose of triggering the logic analyser whenever the input signal goes positive or negative. Switch S4 and transistor T3 are included so that the operator can select whether the logic analyser is to receive a

positive (S4 in position b) or negative (S4 in position a) trigger pulse (MT).

So far so good. The input signal has now been stored in memory, that is, it is held in RAM. Therefore, it has to be read from RAM before it can be displayed on the oscilloscope screen. If an A/D conversion is necessary for a signal to be stored in RAM, it follows that the reverse (D/A) is required for the signal to be read from RAM. For this reason the D/A converter IC4 (IC3's opposite number) is included in figure 1. The amplitude of the analogue output signal at pin 4 of IC4 is determined by the logic levels of all eight data inputs (pins 10...17). Opamp A4 further amplifies the resultant analogue output signal by a factor determined by the setting of potentiometer P5. The output of A4 then becomes the input signal of a conventional oscilloscope, which, together with the circuit just described, adds up to a first class storage scope.

### Construction

Figure 1 shows what the storage scope looks like on paper; the practical version can be seen in figure 2. The storage scope module can be joined to the main board of the logic analyser with the aid of a pair of 31-way connectors, or, alternatively, by using 27 individual wire links. The storage scope module is

positioned in such a way that the component overlays of the two boards are facing each other.

Two wire links on the main board have to be removed when the storage scope is added. These are links E-1 and Y-Z and are shown as dotted lines in the logic analyser circuit diagram. It is a matter of life and death to the circuit, so don't forget! Then the printed circuit board must be linked to the front panel. To minimise interference problems use screened leads for S1, S2, P1 and the BNC input socket. On the printed circuit board side the various screens should of course be grounded. Remember to ground the input socket as well. It is advisable to mount resistors R1...R5 directly on switch S2 itself, as this simplifies wiring considerably. Contacts a2, b2 and c2 of switch S3 are connected directly to solder points Y, X and Z, respectively, on the main board.

### Calibration

Once wiring has been completed, it is time to make the circuit ready-for-use and this involves a few adjustments here and there. Connect the output of the storage scope circuit to (one of) the Y input(s) belonging to the oscilloscope to transform it into a storage scope. With the timebase set to about 256  $\mu$ s/

2

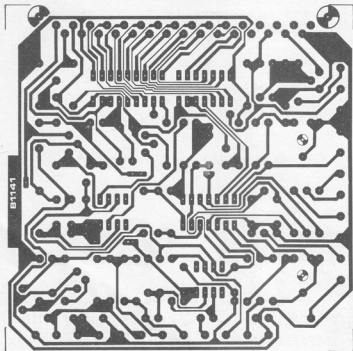

## Parts list

## Resistors:

R1, R2, R8 = 180 k  
 R3, R4 = 18 k  
 R5, R18 = 1 k  
 R6, R9, R13, R17 = 100 k  
 R7 = 270 k  
 R10 = 220 k  
 R11 = 8k2  
 R12, R23, R33 = 10 k  
 R14 = 3k3  
 R15 = 12 k  
 R16 = 22 k  
 R19 = 1 M  
 R20, R27 = 5k6  
 R21, R22 = 47 k  
 R24, R25, R29 = 2k2  
 R26 = 150  $\Omega$   
 R28 = 4k7  
 R30, R34 = 390  $\Omega$   
 R31 = 82 k  
 R32, R35 = 3k9  
 P1 = 100 k linear  
 P2 = 10 k linear  
 P3 = 25 k linear  
 P4, P5 = 5 k preset

## Capacitors:

C1, C2, C3, C8, C9 = 100 n  
 C4, C6 = 33 n  
 C5 = 2n2  
 C7 = 120 p  
 C10 = 330 p  
 C11, C13 = 1  $\mu$ /10 V tantalum  
 C12 = 1 n

## Semiconductors:

T1 = BC 557  
 T2 = BF 256A  
 T3 = TUN  
 T4 = BC 517  
 D1, D2, D4, D5, D6, D7 = DUS  
 D3 = zener diode 5V6/400 mW  
 IC1 = LF 356  
 IC2 = TL 084  
 IC3 = ZN 427E-8  
 IC4 = ZN 426E-8  
 IC5 = CA 3080

## Miscellaneous:

S1 = single pole switch  
 S2 = 3 position wafer switch  
 S3 = double pole toggle  
 S4 = single pole toggle

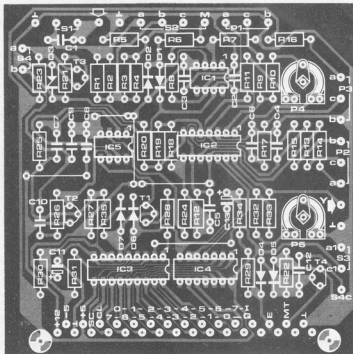

Figure 2. The component overlay and copper track pattern of the storage scope printed circuit board. Remember to remove the dotted wire links on the main board of the logic analyser.

div, turn P1 anti-clockwise (towards -5 V). Then press the analyser's reset button and, immediately afterwards, the 'manual trigger'. A horizontal line will then appear on the scope. This line must be moved down to the bottom of the screen by means of the DC shift control on the oscilloscope. Next, P2 is turned fully clockwise and after reset-

ting and manually triggering the circuit once again, another line will appear, which now has to be shifted up to the top of the screen with the aid of potentiometer P5.

Connect the Y input of the oscilloscope to pin 6 of IC3 and adjust P2 until the line is in the lower position (the circuit must be reset).

The Y input of the scope is now reconnected to the output of the storage scope circuit. P1 is turned clockwise, S1 is switched off and S2 is switched to 100 mV/division. Now connect the storage scope input to a 400 mV DC voltage. Adjust P4 until a line appears in the middle of the screen. Whenever P4 is adjusted the circuit should be reset and

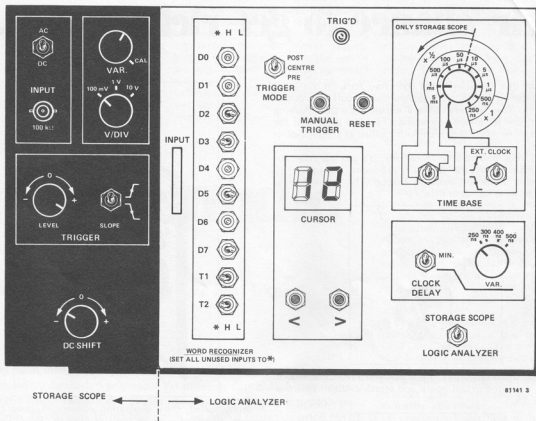

Figure 3. A front panel design (not to scale) for the logic analyser and the storage scope.

triggered manually.

Finally, link the scope's Y input to pin 6 of IC3 and turn P1 anti-clockwise this time. Now adjust P2 until the line on the screen is in the middle. That completes the calibration process.

### A few practical suggestions

There are two connections between the logic analyser/storage scope and the oscilloscope. First, the storage scope output (A4) is linked to (one of) the Y input(s) of the oscilloscope. Second, the oscilloscope's external trigger input must be connected to the logic analyser's trigger output. Furthermore, the time base must be set to about 256  $\mu$ s per division and S3 should be in the 'storage scope' position.

If you are familiar with standard oscilloscopes, the various controls and switches on this particular circuit should be easy to operate.

For the trigger circuit to work properly either S5 or S6 of the word recogniser must be in the L position. The corresponding trigger input must be activated. Apart from the delay switch and the word recogniser, all the controls and switches apply to the storage scope operation as well. Switch S2 of the logic analyser enables the operator to select

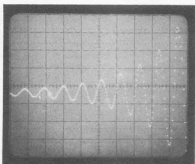

Photo 1. Changing the frequency of a sine-wave generator causes it to behave in a 'strange', non sinewave manner for a short time. By using the Z modulation input of the oscilloscope the cursor can be brought into view.

between two different conversion times. In the a position the A/D converter takes 22.5  $\mu$ s and in the b position it takes 45  $\mu$ s.

The sampling time may be set with the switches S1 and S2 of the logic analyser. An external clock signal is of course another possibility.

In this particular application it is rather difficult to make the cursor visible on the screen as no modulation input is

available. Fortunately this can be remedied. In a dual channel oscilloscope one channel is connected to the output of the storage scope circuit and the other is linked to the Z modulation output of the logic analyser. The 'DC shift' control belonging to the second channel is adjusted until the corresponding horizontal line disappears from view. Now only the cursor point can be seen. The hexadecimal value of the analogue signal is shown on the two seven segment displays.

As mentioned above, operation is very similar to that of an ordinary oscilloscope. It is best to try out a few signals and so test the various controls and switches. It's much easier, and certainly far more effective, to see what happens for yourself than to read reams of well-meant instructions!

Finally, a design for the front panel, as promised. This is shown in figure 3. Note that all the parts involved in the storage scope are located on the left-hand side of the 'dashboard'. Feel free to change the position of the switches and controls, if you have other ideas. Which reminds us, virtually every signal is likely to catch your eye from now, but they are not necessarily all input signals meant for your storage scope! ■

# to all elektor readers who missed their chance to get rich quick . . .

We tipped you off some time ago. Way back in the 1975 'Summer Circuits' issue, we suggested making cuff-links out of power transistors. We even gave a circuit for a LED flashing ornament; one IC, a capacitor and a LED. The ideal basis for an attractive necklace that is currently selling at a high price in Germany.

That was your chance and, regrettably, it's too late now. An enterprising manufacturer is already producing them and they are available in certain shops in Europe. The following is a selection of what he has to offer.



One IC, tantalum capacitors, one preset and a red LED. Mount them on a printed circuit board and attach a chain. This one sells for £ 10.

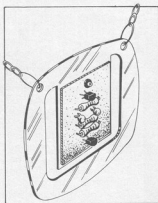

A truly artistic creation. It just goes to show what can be done with a two transistor multivibrator! With a little experience the wearer's body temperature may be deduced from the flash frequency of the (green) LED. Price £ 11.

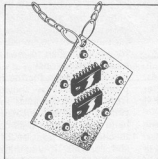

A highly avant-garde design with two ICs. This eight LED 'running light' will burn a slightly larger hole in your pocket at £ 30.

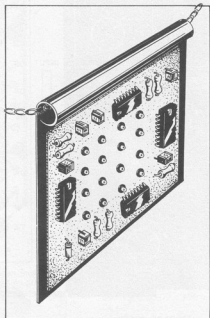

A sophisticated, third generation concept. Sixteen LEDs in various colours, appear to flash at random. Four ICs are required to produce this effect, no less than seven resistors, six capacitors and a diode. Obviously, the price for such space-age technology is bound to be high. Components are forever . . . at £ 40!

'We've obviously chosen the wrong job' was a comment voiced by a number of world famous audio experts as they passed on their way to the AES convention in Hamburg for a series of lectures on digital audio. These 'ornaments' were on view in a show case in the adjacent hotel and available at the reception desk. What is more, we were assured that they were proving to be very popular.

Jogging aids were also on sale in Hamburg: small devices which will indicate your heartbeat on a meter when a finger is inserted. Remember the heartbeat monitor?

On another front, solar energy is 'in'. In fact we were a little late with our 'camping c(l)ock'. On display in Hamburg: a solar alarm clock (with or without radio), a solar lighter (gas), or solar ventilator (a bit on the small side, probably meant for mice), a solar compass (a magnetic compass with a disc underneath, revolving on solar energy) and various mobile midgets, cyclists and other works of art. The best of all: a cigarette lighter, consisting of a concave mirror with a spiral in the centre. Insert a cigarette in the spiral and point it at the sun . . . and it will light the cigarette. (One presumes that smoking is out on dull days!) This twenty-first century technology is available now, at prices that vary from £ 10 to over £ 100.

To many people, modern technology is akin to magic. Technicians are far too prosaic, saying: 'There's nothing to it really. Look, this is how it works . . .'. Interesting, but silly. Don't explain it! A slick tongue and commercial insight can easily sell components for ten times their value. Today, Components are a girl's best friend!

Several years ago, the main topic in audio circles was 'Four channel sound'. At Audio Engineering Society conventions, for instance, half the lectures were dedicated to the subject. Heated discussions arose, with everyone explaining why their system was obviously the best choice. In the end, it all bogged down — no final agreement was reached. Work is still going on behind the scenes, admittedly; we may yet see the day when ambisonics rises like a Phoenix from the ashes.

# digital audio

## Here today, gone tomorrow? Not likely!

Cutting Bach into bits may sound like a heathen ritual — but it's being done by dedicated engineers. At present, digital audio equipment covers the whole range from the Philips Compact Disc to a prototype Mitsubishi 32-channel 16-bit tape recorder with a tentative price tag of \$ 200,000. And there's a lot in between.

Several years ago, we dealt with the basic principles — and problems — in this field (Elektor, September 1979, 'One-nil for audio'). Now, it's time to have another look, to see how things are coming on.

Meanwhile, experts have found a new field in which to exercise their powers of conviction: digital audio. Two years ago, in Brussels, 25% of the lectures at the AES convention were related to this subject and last year, in London, the percentage was even higher. The main bone of contention was the sampling rate: one group wanted 50 kHz, another claimed that 50.4 kHz was much better; 44.1 kHz was proposed; and somebody closely associated with Dutch broadcasting boldly stated that the issue was settled: "The EBU has already standardised 32 kHz, so there is no point in discussing the matter further" . . . Oh dear — shades of the quadrophony controversy?

No! A surprisingly hopeful atmosphere pervaded the recent AES convention in Hamburg. The discussion of sampling rates was dealt several killing blows right at the outset. To put it bluntly, the manufacturers of digital audio recorders are quite happy to go along with almost any standard between 44 kHz and 50 kHz or so: "We'll just have to swap quartz crystals in the

time base. No problem!". Then a brief discussion started on what rate would make for 'easy' conversion to the EBU's 32 kHz, while at the same time maintaining compatibility with NTSC and PAL video recording, motion picture sound and digital audio discs in the consumer market. Quite a tall order, it would seem! The proponents of the various rates were just beginning to warm up when Dr. R. Lagadec of Studer pointed out that he had a system that can convert between *any* two sampling rates. End of that discussion? Not really. Cost is an important factor, and a good choice of sampling rate will make a huge difference to the future of digital audio.

However, the experts soon agreed that there was little point in letting the discussions go on and on around the same loop. The optimum sampling rate depends in part on future developments, and for the present there are enough other important matters to discuss. The general consensus of opinion was: "Let's agree to differ on this point, for the present, and spend our time on more profitable discussions."

A beautiful illustration of the new mentality was given in a brief paper by Dr. T. Doi of Sony. "The author does not believe that the harmonization of sampling rate is an urgent matter." . . .

"The sampling rate on professional side will be greatly affected by that of domestic side, because the final target of professional machines is no doubt to distribute sources into consumer field. Thus the sampling rate will be automatically decided when digital audio discs are marketed, and one of the systems gain the major position in the field." . . . "It is impossible to decide one rate because there are three horses in the race" (the Philips/Sony Compact Disc, the JVC AHD system and the Telefunken Mini Disc — Ed.) "Only thing we can recommend is to advise all the users to prepare master sources on the horse he believes. If this horse loses in the race, he will lose greatly — but it is natural in horse races."

Noteworthy in the above is how the professional world is seen to be closely linked to the final consumer. This insight was also expressed, very strongly, by several others. It was sadly lacking, only a few years ago, in the discussions on four-channel sound. In those days, four or more huge studio monitor loudspeakers were beamed at a few upright chairs in the 'ideal listening position' in order to demonstrate what a given system could achieve. Even a confirmed bachelor would hesitate to do that sort of thing in his living room . . .

However, even in this friendly atmosphere there were problems. With each manufacturer using his own sampling rate, coding system and whatever, it can be extremely difficult to interconnect various machines. It's like English and Americans: they use the same basic language, but communication can still



### Digital recording

At present, the cheapest way to get into digital audio recording is to add a 'PCM audio processor' to an existing video recorder. Aimed at the professional market, the JVC processor shown here costs approximately £ 600. If it were to penetrate the consumer market, with the vastly larger quantities involved, the price could well drop to £ 300 or even less!

This particular version provides 16-bit linear quantization of a stereo signal, at a 44,056 kHz sampling rate. A highly effective error correcting code is used. During playback, this allows for automatic correction of up to three errors in each field. For recording, the analogue input signal is converted into a pseudo-TV signal compatible with VTRs, with a bit-rate of 3.084 Mbit/s.

At the other end of the price scale, Mitsubishi are introducing the X-800 32-channel PCM studio tape recorder. It uses 1" tape and runs at 30 inches per second — a 14" reel gives one hour playing time. A 16-bit linear code is used, and the sampling frequency is 50.4 kHz. The frequency response is flat from 20 Hz to 20 kHz (+ 0.5 dB, -1 dB); the dynamic range is better than 90 dB and distortion is less than 0.05%. The total power consumption is 2.8 kW, and the tentative price tag is \$ 200,000. There are no plans to introduce it into the amateur market.

be quite a problem. As Dr. Lagadec put it: "We must provide a universal interface, to interface between interfaces!"

### What's it all about?

Before going any further, it is perhaps a good idea to give a brief summary of 'what it's all about'.

Audio signals (speech, music, etc.) are recorded and transmitted as continuously changing ('analogue') voltage levels. The rate of change — the frequency — can be anything between 20 Hz and 20 kHz, roughly speaking. The ratio between the highest peak levels and the quietest sounds can be as much as 50 . . . 60 dB — that is, 1000 : 1. To

ensure top quality reproduction, distortion products and noise should be 30 dB or so below the lowest signal level. This means that we want a total signal-to-noise ratio of some 80 dB or more, which takes some doing. However, conventional 'analogue' electronics can do the job — provided there aren't too many copying and transmitting steps involved. But there's the rub: at each step in the chain from original performance to final listener, the quality deteriorates. If this could be avoided, we could provide really top quality reproduction in the living room. Digital signals, on the other hand, can tolerate an enormous amount of abuse. In essence, only two signal levels are involved (+5 V and 0 V, say). This means that, at each step in a digital

recording and transmission chain, you only need to work out which of the two levels was meant; it is then possible to reconstruct the original signal with absolute accuracy.

The idea behind digital audio is to use the extreme reliability of digital techniques for the recording and transmission of audio signals. Without going into too fine detail — we've done that before — the basic idea is as follows. The audio signal is 'sampled' at a fairly high frequency: at least twice the upper limit of the audio bandwidth (somewhere in the 40 . . . 50 kHz range). The signal level found for each sample is then converted into a corresponding digital 'number'; this rapid stream of digital numbers (or 'words') is then recorded on tape or transmitted. At the playback or receiving end, the digital numbers are converted back into corresponding signal levels and — hey, presto! — out comes your audio. If the job is done properly, the output signal will be virtually identical to the original input: the tiny differences between the two are precisely defined by the initial analogue-to-digital and the final digital-to-analogue conversions. The complete digital chain in between has no adverse effect on the signal.

Very neat, you would think. However, when you try to put the idea into practice you discover all kinds of problems and — more to the point — a whole range of alternative options from which to choose. What sampling rate? 50 kHz is a nice, round number for the moment (although 44.1 kHz, 48 kHz and 50.4 kHz are more likely candidates). How many bits? The desired 80 dB signal-to-noise ratio can be achieved if you use 14 bits. However, since most digital systems use multiples of eight bits, it seems more logical to opt for a 16-bit system. That way, it is possible to achieve a signal-to-noise ratio of more than 90 dB, which gives comfortable headroom.

But just think of that for a minute. A 50 kHz sampling rate means that you have 50,000 samples per second, each coded into 16 bits, flying down your cables. That's 800,000 bits per second — for just one audio channel! In a recording studio, you would need to add some control bits (bringing the total per channel up to, say, 24 bits instead of 16) and you might want to use a big 30- or 40-channel mixing desk. Pretty soon, you find that you have to handle something like 50 million bits per second . . . That's rather a lot.

In fact, transmitting this type of bit stream down studio cables is the least of the problems. Recording it on tape is one step more difficult, but video tape recorders (or specially designed digital audio machines) can handle that job. Then you come to the problem of editing a digital tape. You can't just cut the tape and splice the ends together, as you would with an analogue tape: the digital recording will contain all sorts of

sync bits, error correction data and so on, that must be handled with utmost care. So manufacturers are offering an extensive range of electronic tape editing machines.

Then, think what happens if you want to do any fancy manipulation along the way. Modifying the sampling rate, for instance, or digital code conversion to enable two different machines to communicate. You have to handle millions of bits per second, without introducing any errors, while new data is continuously coming down the line. In no time at all you find yourself involved in very high speed micro-processor-based systems.

However, all this is actually being done. Professional recording studios are using digital recorders; broadcasters are using digital transmission lines; and prototype digital mixing desks are being demonstrated. At the consumer end of the scale, the Compact Disc is almost ready for full-scale launching. Digital audio is really on the way!

### So what?

What does it all mean, in practical terms? How will it effect sound reproduction in our living rooms?

Already, some gramophone records are pressed from digital recordings ('PCM' discs). If you've got top quality equipment, you can hear the difference — if you listen carefully. The more money you plough into your hifi system, the more chance you have of being rewarded by an audible improvement when listening to a PCM recording. But is it worth it?

At the recording studio end, digital audio makes it easier to obtain and retain high quality throughout all intermediate steps. In principle, this could lead to less expensive records — once the initial investment has been recuperated, that is. At present, PCM recordings tend to be more expensive than the conventional type.

So who stands to benefit? The engineers, who have a stimulating job exploring a new field? The manufacturers, who hope to supply a whole new range of equipment? Or the final listener, who can only hear the difference if he is prepared to buy the most expensive of audio equipment?

All in all, it might seem that digital audio is not such a good thing, from the consumer's point of view. So why are we devoting so much time and effort to it?

If you take the short-term view outlined above, the obvious conclusion would be that it's all a waste of time. On the longer term, however, the potential is enormous. At present, the weak link in the chain is the final product: an analogue vinyl disc or magnetic tape. A brand-new record may sound great, but once it's been played a few times the quality starts to deteriorate rapidly. This

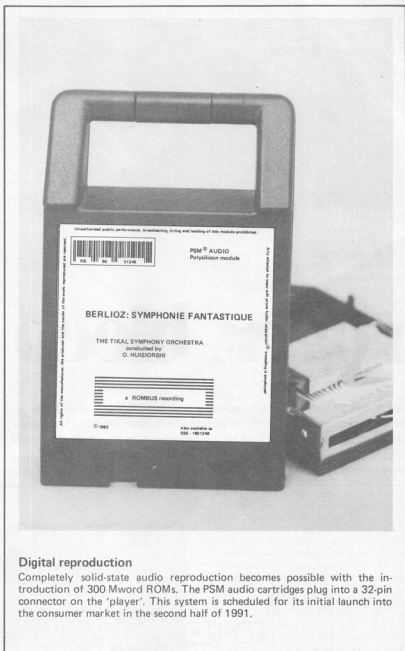

### Digital reproduction

Completely solid-state audio reproduction becomes possible with the introduction of 300 Mword ROMs. The PSM audio cartridges plug into a 32-pin connector on the 'player'. This system is scheduled for its initial launch into the consumer market in the second half of 1991.

is certainly true in the average home, where dust and less-than-perfect record players lead to fairly rapid wear and tear. Not to mention the accidental greasy fingerprint or scratch.

In the near future, digital discs will start to change all this. They can tolerate an enormous amount of abuse, and still offer 'brand-new' sound quality. Goodbye snap-crackle-pop, at least as far as the record is concerned! The same is possible in tape recording, although in that case it is unlikely to be cheap. You would need a video recorder, instead of a normal tape deck; and then, for another £ 600 or so you can buy a PCM converter — JVC make one, for instance. But all this is unlikely to be the final step. With all this sophisticated electronics, the primitive mechanical

motors, drive belts and pulleys are doomed to die an inglorious death. In the not-too-distant future — within 10 or 15 years, say — it should be possible to use a solid-state memory to replace the compact disc. And by 'possible' we mean more than 'technically feasible': it should be possible to do it at competitive prices, even! That'll be the day . . .

E.R. de Jager - PE1 DQL

# roger bleep

The Roger bleep is getting to be more and more popular with Hams and other transceiver users. Various versions have been available for some time but the circuit described here differs from its counterparts in that it gives a gonglike sound. This adds a personal 'note' to the end of transmissions.

The transistor is normally operated by the push to talk (or PTT) switch on the microphone. Usually, when this is pressed it will earth a pin in the microphone socket causing the transmit/receive relay to be operated. The PTT switch is shown as S2 in the circuit diagram. The connections to S1a and the bleep output can all be made at the microphone socket inside the transceiver.

Operation is as follows. Referring to the circuit diagram in figure 1, switch S1 will be in the 'b' position for the bleep to be selected. During a transmission the PTT switch will be closed and the transmit relay is operated via transistor T1. Capacitor C2 will become fully charged and its purpose is to hold the transmit relay on for a short period of time after the PTT switch is released. This is the bleep time period. When C2 has fully discharged the relay is released and the transceiver will revert back to receive.

It would be better perhaps to call this circuit a roger gong since that is closer

1

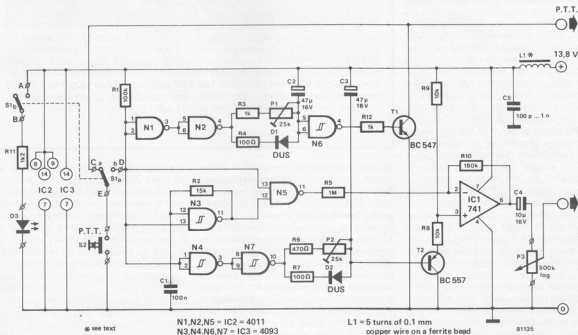

Figure 1. The circuit diagram of the roger 'gong'. In the switch positions shown here the circuit is not operative.



to the sound that it actually makes which explains the purpose of the rest of the circuit in figure 1. The gong tone is generated by gate N3, R2 and C1. The decay effect is created by C3 which was charged in exactly the same manner as C2. As C2 discharges, the amplitude of the square wave output of IC1 will gradually diminish to zero.

### In detail

With switch S1 in the 'b' position the PTT switch will take both inputs of

gate N1 to a logic '0'. The gates N1 and N2 are connected as a double inverter and therefore the output of N2 will also be low. When the PTT switch is released the input of N1 will taken high by R1. The output of N2 will follow suit and C2 will now charge via diode D1. This would happen very quickly if R4 had not been included to control the current and preserve the otherwise short life of the diode. As soon as C2 becomes fully charged gate N6 will produce a logic '1' at its output causing T1 to conduct. As a result, the transmit/receive relay in the transceiver will operate and 88's,

73's and all the high numbers will go out as usual.

Now what happens when the PTT switch is released? Both inputs of N1 and the output of N2 will be taken high. The charge on C2 will slowly decrease via the preset pot P1 and R3 and D1 will not conduct. Adjustment of the pot will determine for how long the transceiver will be held on transmit, that is, the length of time of the roger signal. The gong sound is produced by the gate N3 (a Schmitt trigger with an RC network) and its output takes the form of a squarewave. By changing the value of C1, the tone produced can be made higher or lower in pitch.

If by some chance switch S1 is operated while the PTT switch is closed, in other words during transmission, N5 will ensure that the oscillator output does not reach IC4. This is done by the logic '0' (via S1 and the PTT switch) on pin 13 of N5 thereby inhibiting its output. On the release of the PTT switch pin 13 will once more go high and the gong tone will reach the inverting input of IC1 via R5.

The non-inverting input, pin 3 of IC1 (a 741), will be held at half the supply voltage level when transistor T2 is conducting. When this transistor is not conducting at all, the input of the opamp will rise to virtually supply voltage and the amplifier will be switched off. However, a lot happens between these two levels as we shall see.

Capacitor C3 is charged by exactly the same method as C2. Its discharge, although at the same time as C2, does a slightly different job. When fully charged, C3 will hold the base of T2 down causing it to conduct. Pin 3 of the 741 will then have about half of the supply voltage appearing on it and the amplifier will produce an output consisting of the square waveform from the 'gong' oscillator. Capacitor C3 will now start to discharge via P2 and R6 and the base of T2 rise. This has the effect of slowly decreasing the modulation range of IC1. The result will be an output tone that begins fairly loudly and then gradually diminishes in volume. This creates the gong effect which is made even more impressive by selecting a lower frequency than is usual for roger bleeps. The discharge time of C3 is adjustable by means of preset P2.

Switch S1b is used to switch on LED D3 to indicate that the roger gong is selected.

As this type of circuit is highly sensitive to HF feedback from the transceiver, it will have to be fitted into a metal case which must be earthed. To prevent HF interference from entering via the supply lines, the choke L1 and C5 have been included. L1 is simply five turns of thin enamelled copper wire threaded through a ferrite bead.

As for the CMOS ICs, it will be necessary to use the UB series to make use of their higher maximum UCC of 18 volts.

### Parts list

Resistors:	Semiconductors:
R1 = 100 k, 1/8 W	IC1 = 741
R2 = 15 k, 1/8 W	IC2 = 4011
R3 = 1 k, 1/8 W	IC3 = 4093
R4, R7 = 100 $\Omega$ , 1/8 W	T1 = BC 547
R5 = 1 M, 1/8 W	T2 = BC 557
R6 = 470 $\Omega$ , 1/8 W	D1, D2 = DUS
R8, R9 = 10 k, 1/8 W	D3 = LED 5 mm
R10 = 180 k, 1/8 W	Capacitors:
R11 = 1k2, 1/4 W	C1 = 100 n MKM
R12 = 1 k, 1/4 W	C2, C3 = 47 $\mu$ /16 V
P1 = presetpot 25 k	C4 = 10 $\mu$ /16 V
P2 = presetpot 25 k	C5 = 100 p... 1 n
P3 = presetpot 500 k	Coils:
	L1 = 5 turns of 0,1 mm copper wire on a ferrite bead
	Miscellaneous:
	S1 = double pole toggle

2

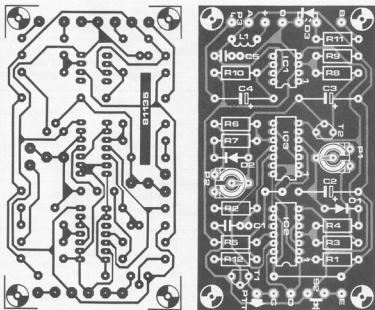

Figure 2. The track pattern and component layout of the printed circuit board. The finished board must be mounted inside a metal case.

Hans P. Baumann

# talk to computers (2)

— and let them listen to you

In the first article on this subject various methods of 'teaching' computers to talk were described. Of course, conversations would be rather one-sided unless the machine is also able to 'listen' and take note of the human operator's point of view. Unfortunately, however, hearing and understanding involves a far more complex process than speaking. When a computer 'talks' the human brain is quite capable of complementing the machines 'tinny' voice and lack of vocabulary and grammar. When the situation is reversed, however, and it is the computer that has to listen, the device is not capable of adapting so easily.

Experiments are currently being carried out in the field of speech recognition by computers. Since computers do not possess any inborn intelligence or experience, a speech recognition unit must learn all the faculties pertaining to hearing, step by step. This demands a much more powerful 'brain' than that which is required for speech synthesis.

Up until recently, speech recognition devices have usually featured an *analyser* to split up the entered speech signal into certain characteristic segments and a *classifier* to compare these characteristics with reference patterns stored in memory. When they

Word recognition systems, on the other hand, are much more flexible, as they do not have to follow a strict word order. Nevertheless, they too involve certain problems. If an individual word is to be picked out from a whole flow of speech, both the beginning and the end will have to be accurately defined. One method is to use a threshold value detector and this will then test the input amplitude. Alternatively, a detector with a filter connected to it will indicate the beginning or end of a word whenever the corresponding frequency band is exceeded. One disadvantage here is the system's sensitivity to interference: any noise that happens to exceed a

correspond — in other words, when the speech pattern is recognised — the 'sentence' can be printed out so that the computer's 'understanding' can be checked.

Speech patterns are processed by two main types of computer systems:

1. Sentence recognition devices and
2. Word recognition devices.

The first group is used for purposes requiring a very limited and precisely defined vocabulary, for example in monitoring or control tasks where the spoken command substitutes a simple manual operation such as pressing a button (for instance, remote control of a television set).

certain threshold will activate the classifier and so lead to errors.

A much more reliable system is one that continually compares patterns, but this of course complicates matters considerably as each input signal in turn will have to be compared with the reference patterns stored in memory.

## Signal segmentation

What are the criteria that determine how a speech signal should be segmented? Before we go into this it should be established whether in fact speech segments can be compared with

1

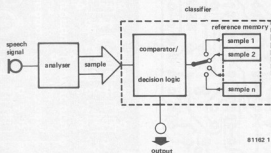

Figure 1. This block diagram shows the principle on which virtually every type of speech recognition device has been based up until now. An analyser splits up speech signals and defines the segments according to their characteristics. Such segments are then compared to reference patterns stored in memory. If they correspond, the pattern is recognised and the contents can be further processed, for instance, they can be printed.

those stored in memory. So many factors are involved, some of which may be purely arbitrary. To start with, there are the phonemes (individual sounds which make up each word). After dividing them into voiced and unvoiced they can be classified according to a whole set of different categories. Then they have to be seen in context, surrounded by other vowels and consonants which affect the pronunciation of a phoneme considerably.

The duration of individual segments should not be identical every time, as in certain contexts some words receive more stress than others, etc. This aspect will also have to be taken into account when the reference patterns are keyed in/recorded.

There are proven methods whereby voiced and unvoiced phonemes can be discerned without any difficulty:

a. Voiced sounds are usually periodic (they can be synthesised by using tone generators - see the article published in the May issue of Elektor). As they depend on the physical structure of the 'vocal tract', their vibrations are unable to exceed a particular frequency, which will be a lot lower than that of unvoiced phonemes and will not include nearly so much noise. Thus special filters can be incorporated to 'spot the difference' between voiced and unvoiced sounds.

b. Another method of determining whether a particular sound is voiced or unvoiced is simply to count the number of 'zero-crossings' during a certain period of time. The count at the end of the test period will be found to be directly related to the average fundamental frequency. If the sound was unvoiced, the count would be much higher than that for a voiced sound (see a.).

c. 'Auto-correlation': the entered signal is delayed and multiplied by the original signal to detect whether the sound is voiced or unvoiced. With the aid of a variable analogue delay line the speech signal can be delayed by a certain factor as compared to the original signal. By multiplying the original and the delayed signals together and then integrating the result, a peak level can be obtained at the output of the integrator by adjusting the delay time, provided that it is a voiced signal. The period of the delay thus achieved will correspond to the period of the voiced signal. Unvoiced, non-periodic signals, on the other hand, only reach a limited level at the integrator output and are, therefore, easy to distinguish.

## Memorising the reference patterns

Before the speech recognition device can be set to work on a particular signal, every single reference pattern pertaining to that signal must be stored inside the 'experience memory' of the

2

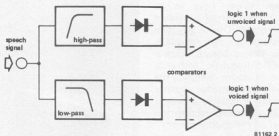

Figure 2. Filters are used to distinguish between voiced and unvoiced phonemes.

3

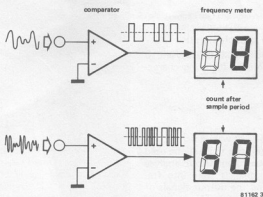

Figure 3. Sounds will be acknowledged as either voiced or unvoiced, depending on the number of zero-crossings during a certain, pre-determined period (about 10 ... 50 ms).

Figure 3a gives an example of a voiced speech signal and figure 3b that of an unvoiced signal. The frequency counters indicate how many zero-crossings take place within a certain period.

4

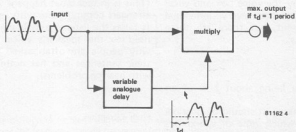

Figure 4. How periodic (voiced) signals are defined in auto correlation. The speech signal is delayed by a variable amount and multiplied with the original signal. The integrated output signal will be at a maximum when the delay time  $t_d$  is equal to the duration of the signal.

machine. One major drawback is the fact that speech patterns differ greatly from one person to another and so it is difficult to establish a norm. Instead, average values have to be chosen (either in the form of individual words or sentences). Obviously, this recognition system can not be 100% reliable, as the device has to operate within a specific linguistic tolerance range. To put it more simply: the machine can only acknowledge whether a certain segment is roughly identical to... Thus, in this case, recognition does not depend on the speaker.

If recognition is to be determined according to an individual speaker, the recognition tolerance range will have to be restricted. All the reference patterns will therefore belong to one person only, although here too the average values will be taken, as the individual's voice also changes constantly by using different inflexions, emphasis etc. to suit the particular occasion.

### Analysing the speech signal

The input speech signal is analysed to filter out data blocks featuring characteristic patterns.

#### Formant analysis

The 'Voder', which was described in last month's issue, can not only be used to synthesise speech, but also to analyse it. The input signal is split into frequency bands and the output signals of each filter are rectified. The resultant DC levels provide a reasonable idea of the entire signal spectrum. Vocoders work with between 10 and 20 frequency bands covering a continuous tone frequency range. In speech analysis, however, the entire range is not required, as of course the human voice can produce but a small part of it.

Three or four formant filters are enough to capture the main resonances of the spoken word and calculate the amount of vocal energy involved. Resonance is determined by the voice box and vocal tract and therefore every individual sounds different, but there are three average ranges:

500 Hz  
1400 Hz  
3300 Hz

the tolerance being about  $\pm 1/3$  of an octave.

Roughly speaking, it should be possible to calculate which type of sound was input by analysing the energy content of each formant channel. Additional information can be obtained by the number of zero-crossings of each signal inside the filter bands. Simple though this method may be, it does allow for 90% reliability in individual speech analysis and 80% when several speakers are involved. The system could be



Photo. The acoustic data reception system (ADES) by AEG-Telefunken is being used here to produce wiring diagrams. The operator can enter the data from the circuit diagram directly into the computer by means of a microphone. Afterwards, the computer has to 'read back' the data display via the headphones, so that any mistakes can be corrected.  
(Photo by AEG-Telefunken.)

further improved by adapting the signal processor to the pitch of the speaker. (This is in fact what happens when two strangers communicate with each other. It takes the listener a little while to get used to the speaker's voice, which is why people are often asked to repeat their sentences and has nothing to do with hearing problems).

#### Pitch extraction

Unlike continuous tone signals which feature constant amplitude and vibrations (such as a long vowel) a 'flowing' speech signal does not really have its 'own' frequency, as it is impossible to repeat the same signal in exactly the same way. Both the amplitude and the vibrations are very irregular and keep fluctuating. Never-

theless, there is a certain average or 'pseud' frequency which lasts a very short space of time and this is taken to be the pitch.

Pitch extraction takes place as follows: the peaks of the speech signal waveform are filtered out as much as possible after which the 'clean' signal is shaped into a series of pulses. As a result, only the pitch frequency will remain.

A programmable frequency divider is then used to synchronise the scan frequency to that of the pitch. Subsequently, the speech blocks can undergo a Fourier transformation and the 'spectral time sequences' are then compared by the allocation logic to the stored reference sequences. Considering the complexity involved, it is hardly surprising that this particular process can only be carried out by microprocessors or by minicomputers, if

higher speed and greater recognition reliability are sought.

### Problems involved in pattern comparison

The 'decision logic gate' has two inputs: one for the characteristic sample derived from the analyser and another input to which each reference pattern is fed in turn and scanned. The device has a hard time in making a decision, as no two patterns are *completely* alike. It must therefore decide first how much the input signal may deviate from the reference pattern before answering 'not equal'.

If the 'about the same' range is too wide, wrong decisions may be taken. If, however, this is too narrow, it will be overcritical. Finding the ideal compromise is a complicated procedure and will not be dealt with here.

As far as the reference patterns are concerned, these are not stored in a random order in memory, but are allocated according to their category. The heading for each category may be voiced, certain allophones (transitions between phonemes), etc.

5

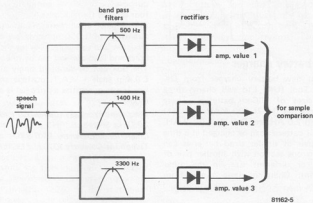

Figure 5. The block diagram of the formant analyser. It looks like the analysis section of a vocoder. By analysing the amplitudes of the various formant channels, the sound in question can be defined.

6

### Speech recognition today

As you may have gathered from the various problems discussed above, speech recognition is as yet in a fairly preliminary stage of development. It is very difficult to put present-day speech recognition devices into practice on a large scale for the following reasons:

- Such devices are extremely expensive. They require powerful microprocessors and special software. More linguistic information needs to be obtained before suitable programs can be written.
- Systems that are used to distinguish between several speakers are still very unreliable.
- Their main handicap: the speed at which existing systems operate is far too low. By way of illustration: the input to output ratio is 1:200, in other words, a short sentence lasting 6 seconds can be printed only after about 20 minutes in spite of the fact that the computer is comparing 100 patterns per second! Processing times should be reduced considerably in the future by using several computers.

Experts in the United States recently claimed that 'type writers with ears' would be available, rather optimistically, as early as 1983. In Japan, various manufacturers have introduced TV sets that can be ordered to switch on and off, change to another channel and adjust the colour and volume - a vocal remote control system. Although this is still a far cry from holding a conversation with a machine, it goes to show that research in this field is showing a certain amount

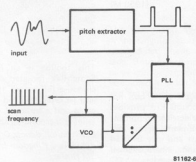
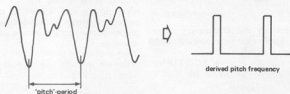

Figure 6. In addition to formant analysis, pitch analysis is also important. Pitch extraction is used to derive the (average) speech frequency from the signal. Subsequently, the scan frequency is synchronised according to the pitch frequency calculated. By analysing the pitch 'development' samples can be taken which are then classified.

of success already. By the turn of the century, computers will probably be operated by using spoken commands only.

Source:  
Flanagan, J.L.: *Speech Analysis, Synthesis and Perception*.  
New York, 1972.

# market

## NICAD battery charger

A compact new battery charger from OK Machine & Tool (UK) Ltd will charge three different sizes of NiCAD batteries. These include sizes AA (HP7) 500 MAH, C (U11) 1.0 AH and D (U2) 1.0-1.2 AH. Two or four batteries can be charged at a time and any pair of similar sized batteries can be fitted in one section with another pair of the same, or different size, in the other compartment. Charging times range from 10-16 hours.

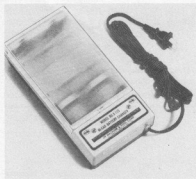

A safety catch on the transparent cover ensures that the charger only operates with the cover closed.

The charger is available as model BC-3-115 for 115 V operation or BC-3-230 for 230 V operation.

OK Machine & Tool (UK) Ltd,  
Dutton Lane,  
Eastleigh,  
Hants SO5 4AA.  
Telephone: 0703 610944.

(1953 M)

colours in large quantities are available on request).

They can be machined, engraved or silk screened and the maximum working temperature is 65°C. These extremely useful general purpose boxes come complete with lid and four self-tap fixing screws.

For original equipment manufacturers using quantities of 1,000 upwards, we can provide a customised tooling service for the lids, grills, holes and logo's which can be foil blocked.

The box can be supplied singly at a price of £ 0.49p each + V.A.T. postage and packing. For larger quantities a price list is available on request.

Electronic Products (Coventry) Ltd.,  
20 Duke Street,  
Chapelfields Coventry CV5 8BU,  
Telephone Coventry (0203) 713209 (2 Lines).

(1954 M)

## Free Scotchflex cutting tool and cable guide

A free hand cutting tool and cable guide are being offered by 3M United Kingdom Ltd with all initial orders for one roll or more of either Scotchflex 3603 jacketed or 3517 jacketed/shielded cable. The offer runs from March 1st to May 31st.

The 3430-7000 hand tool and 3507 cable guide have been specifically designed to prepare jacketed, jacketed/shielded and ground plane cables for termination. The hand cutting tool is used to score the pvc jacket, while the cable guide ensures a straight perpendicular cut and acts as a measurement reference.



This tooling is an important part of the Scotchflex jacketed cable system which includes a full range, 10-64 ways, of jacketed and jacketed/shielded 28 AWG stranded flat cable and a series of cable clamps for strain relief and grounding applications.

Electronic Products Group,  
3M United Kingdom Ltd.,  
3M House,  
PO Box 1,  
Bracknell Berks RG12 1JU.  
Telephone: (0344) 26726

(1957 M)



to fixed-station use. The new power-supply unit is supplied as an attractive, wood-encased, desk-mounted pack, and can be operated off conventional 220-240 V a.c. mains, 110 V a.c. supplies for site work, and from a local or vehicle-mounted 12 V d.c. supply. Facilities for plugging in a local or mast-mounted external aerial are also provided.

Dymar Electronics Ltd.,  
Colonial Way,  
Radlett Road,  
Watford,  
Herts.  
WD2 4LA

(1964 M)

## PCB repair kits

OK's new range of 2570 series printed circuit track repair kits will pay for themselves after just one 'on the spot' salvage job, it is claimed. Deluxe, standard and economy kits



are offered, all containing master frames with tracks and fingers, eyelets and eyelet setting tools. In addition both Deluxe and standard kits have consumable items such as acids, abrasives, epoxy, flux and cleaners plus tools, including clamps, tweezers and trimming knife. The Deluxe kit also has a temperature controlled fine point soldering iron and high quality pliers of varying types.

OK Machine & Tool (UK) Ltd.,  
Dutton Lane,  
EASTLEIGH,  
Hants SO5 4AA.  
Telephone: 0703 610944

(1968 M)

## Box n° 7544

The moulded high impact styrene box no. 7544 from Electronic Products Ltd. provides an excellent housing for electrical equipment such as, portable test instruments, alarms, etc. They are extremely robust and may be used in a variety of applications where a small enclosure or potting box is required.

The dimensions of the box are 75 mm x 75 mm x 44 mm depth, and can be supplied ex stock in two colours, grey or black; (other

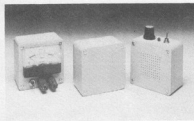

## Radiotelephone power supply

A new radiotelephone power supply from Dymar Electronics, the X2000PSU, converts the company's recently introduced Lynx 2000 portable/mobile radiotelephone system

# market

# market

## 19" steel case

This new 19" bench case from Daturr Ltd., designated 'Elprotec' meets the DIN 41494 specification.

Designed in sturdy, but attractive, sheet steel it has vertical extrusions provided, with T slots for the patented M5 Spring Nut, which allows for fixing of front panels and any additional units. As an alternative a threaded rail (full unit height) can be used.

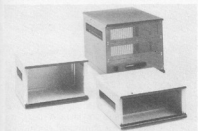

There is also a 3  $\mu$  connecting panel which has a connector and a rubber grommet for wiring protection. The rear panel, with or without ventilating slots, is completely removable.

The Chassis runners are made from high quality, strengthened aluminium extrusions, available for all depths of cabinet. A facility for fitting of telescopic slides is standard — maximum load capacity 380 N (38 Kg). Height is from 3  $\mu$  to 12  $\mu$  with a plug-in depth of 311, 411 or 511 mm. Units between 4  $\mu$  and 12  $\mu$  are fitted with handles.

The Elprotec style and design is aesthetically appealing — with protrusions at the front and rear to give protection to electronics mounted in 19" centres.

Elprotec is available in two tone colours. Basic colour is Azure Blue (RAL 5009) with black flashing at top and bottom. Handles are also finished in black.

Daturr Ltd.,  
Unit E, Roan Industrial Estate,  
Mortimer Road,  
Mitcham,  
Surrey CR4 3HS.  
Telephone: 01-646 2766

(1965 M)

## High-power, low-cost relay

Diamond H have introduced a power relay with a switching capability of 30 A, yet which costs, depending on its coil voltage, only around £3.00 in quantities of 100.

Designated the Class 88UKD, from Magnecraft, this relay is a single-pole, single throw device with normally open double-make contacts. The use of double-make contacts means that the relay exhibits significantly better arc extinguishing characteristics on contact break than is normally the case with a conventional, single-contact device. It is

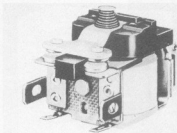

capable of switching 30 A at 230 V through its heavy-duty silver alloy gold glazed contacts, and is rated at 1HP. Both a.c. and d.c. coil versions of the relay are available.

The moving dual contacts of the Class 88UKD relay are secured onto a moulded phenolic insulator, while the two individual stationary contacts are assembled onto a glass melamine board with integral 0.25 in. quick-connect terminals. Power to the relay coil is similarly coupled via quick-connect terminals.

The Class 88UKD relay has been specifically designed for the U.K. market, and is available ex-stock from Diamond H.

Diamond H Controls Ltd.,  
Vulcan Road North,  
Norwich NR6 6AH,  
Telephone: Norwich (0603) 45291/9.

(1966 M)

## Night Owl, the D.I.Y. radar system

Night Owl is a radar controlled courtesy light and intruder detector built for the domestic market. Night Owl can protect with its radar a forward range of 100 feet.

When the radar system detects a moving vehicle or person the internal lights are automatically turned on. The lights stay on for an adjustable time period after the last movement has ceased. However if further movement is detected the lights will come back on. The unit is programmed to accept only continuous movements, the anti-flutter system rejects momentary and oscillatory movements (i.e., doors, curtains, trees etc.).

The detection range is adjustable from 6 to 100 feet and the light duration can be set from 1/2 to 10 minutes. (If an audible alarm or extra light is required an extra set of contacts are already built into the Unit).

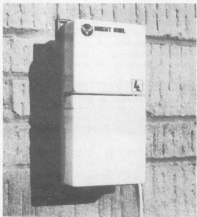

The compact unit is sealed against weather and can be installed by any competent 'do-it-yourself' enthusiast or electrician. A 220/240 V mains supply is required for operation. The simple and functional design is unobtrusive and may be placed wherever an automatic lighting system is required such as front and patio doors, dark passages and stairs, alleyways, courtyards, outbuildings, etc.

Loadpoint Ltd.,  
Chelworth Industrial Estate,  
Cricklade,  
Swindon,  
Wiltshire, SN6 6HE.

(1958 M)

## Light-sensitive coded magnetic tapes

This new concept has been developed to enhance the reliability of telephone answering machines and data cassettes. The process involves the removal of oxide from standard magnetic tapes to form precise and accurately coded light 'windows' in the tape. Existing light detectors and control circuits within the tape transport mechanism can then be used to respond to the coded message, for example 'end of tape' messages in telephone answering machines. The process does not in any way affect the strength or durability of the original tape nor does it affect the oxide coating above and below the window which can still be used to carry magnetically recorded messages.



The coded windows can either be circular or rectangular slots as require and can be situated anywhere along the length of the tape. Both reel-to-reel and 'Compact Cassette' tapes can be supplied. The cassette tapes are assembled in either screwed or press fit bodies and the complete assemblies are stress relieved and torque tested after manufacture. Cassette sizes C1 to C120 are available and all tapes can be supplied with, or without, leaders.

Monolith Electronics Co. Ltd.,  
5/7 Church Street,  
Crewkerne,  
Somerset,  
Telephone: (04060) 74321.

(1963 M)

# market

# market

## Miniature electronic brushless motors

Toko's new range of miniature electric motors were inspired by the micro HiFi cassette player's need for a drive system that provided a substantial advance on existing low voltage DC motor technology.

The SM 202 motor is controlled from a specially developed servo IC (KB4453) using a reflective tachometer system incorporated into the motor design. This system provides extremely accurate speed control from a low voltage (nominally 3 V) source. In fact, over an average battery supply range of 2 V to 3.5 V, the speed fluctuates by just 20 rpm in a nominal 2,600 rpm.



Wow and flutter is less than 0.02% RMS — with torques available in the range 4 to 14 gm.cm.

Maximum efficiency of nearly 75% is achieved at 1000 rpm with the SM202.

Ambit International Ltd.,  
200 North Service Road,  
BRENTWOOD,  
ESSEX CM14 4SG  
Telephone: (0277) 230909.

(1962 M)

## Book-shelf loudspeaker

The 'CECILIA' is a top quality book-shelf loudspeaker which can be 'built in a weekend' for around a total of £ 35 per pair (subject to finish and cost of raw materials).

One of the main contributing factors to the low cost is that there are no electronic components, such as crossovers etc., except for the drive units themselves, (one in each cabinet). The drive unit is the readily available Pioneer TS. 107, originally developed for the car. It can be purchased at most car radio centres throughout the country. It incorporates a strontium magnet and a compact dual cone which gives a full extended frequency range of 50-20,000 HZ!

The finished speakers are amazingly efficient, they will produce 91.5 dB at 1 watt/metre. With a power handling of twenty watts maximum they are ideal for most domestic Hi-Fi situations.



The complete step-by-step, easy to follow construction guides and full-size blueprint plans are very clear and easy to read, only the simplest of tools and skills are required to build these remarkable speakers. The whole construction guide package, including p & p, is good value at only £ 2.50.

D-I-Y Hi-Fi,  
York House,  
Swan Street,  
West Malling,  
Kent,  
ME196LB.

(1961 M)

## Timing analyzer with full probe set

The Gould 920-D timing logic analyzer is now being offered with a complete set of ten high-performance probes at a reduced price of £ 865 (plus V.A.T.). The probes, specifically designed for logic analysis work, have very short risetime characteristics for detecting pulses in the nanosecond region, and are designed so that widely separated circuit modes in the system under test can be accessed.

The Gould 920-D is a compact, lightweight instrument designed for use with an external oscilloscope for display purposes. It has nine input channels, and the ninth channel can be used as an extra signal input, as a trigger marker and qualifier, or as an external clock qualifier.

The triggering facilities provided allow combinational triggering on a preselected grouping of signal levels, or the selection of desired

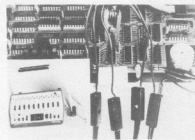

logic states from a bit stream. A latch input mode is provided to allow for the capture of pulses or 'glitches', down to 10 ns in width, irrespective of the clock or sample interval selected for data recording.

Both delayed and pretrigger modes of recording are available on the 920-D, and delayed recording may be specified in terms of clock periods or user-specified events. The instrument will accept an external clock at any rate from d.c. to 20 MHz, and clocking can be selected on the positive or negative edge of the clock. Moreover, the auxiliary (ninth-channel) input allows qualifying of the record clock so that only desired signals are recorded in memory.

Gould Instruments Division,  
Roebuck Road,  
Hainault,  
Essex.

(1956 M)

## VHF helical filters: CBW and CBT

The CBT and CBW filters represent an excellent 'stock' solution to many problems facing all types of VHF radio design that cover the range 135 to 200 MHz. A single two pole unit (the CBW as illustrated) can provide over 85 dB attenuation at the LF image point in VHF receivers using 21.4 MHz 1Fs — with a 2 dB insertion loss and 4.5 MHz nominal bandwidth centred on 170 MHz. The 3 pole CBT series is over 80 dB down at 10.7 MHz below the centre frequency, effectively preventing local oscillator radiation in receivers/synthesisers with 10.7 MHz 1Fs. The 3 dB bandwidth is 4 MHz centred on 170 MHz.

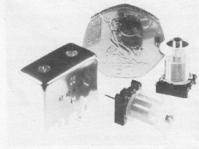

The basic design can be configured for a variety of bandwidths and LF trap points — and Ambit provides a custom design facility for specific applications. In transmitting applications, the CBT and CBW filters can be used to clean the output of synthesisers before amplification.

Ambit International Ltd.,  
200 North Service Road,  
Brentwood,  
Essex CM14 4SG.  
Telephone: (0277) 230909

(1970 M)

# market



# market

## Sealed DILswitch

The Erg 023 is a new range of totally sealed DILswitches. First in the series is an 8-module component comprising eight, single throw DILswitches. Total base and top sealing makes the entire unit impervious to flow soldering and solvent cleaning problems. Each switching contact has a minimum of 1  $\mu$ m of gold plating, making them ideal for very low level or high power load switching. Maximum contact resistance is 50 m $\Omega$ . Designed to exceed BS9565/6, MIL-S-83504 requirements,

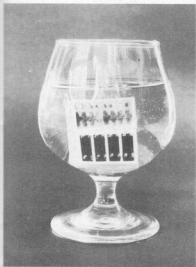

the Erg 023 components can each reliably switch 1  $\mu$ V to 100 V, 1  $\mu$ A to 1 A, up to 10 VA. Non switching ratings are 100 V a.c. 5 A max. Each switching member is both numerically and colour coded. Some 15 make, changeover and ganged styles are to be available.

*Erg Components,  
Luton Road,  
Dunstable,  
Bedfordshire LU5 4LJ.  
Telephone: 0582 62241*

(1998 M)

## Resistor selectors from Delpak

Delpak found an internal need for resistor boxes containing preferred values for use in the production test and calibration department. The usual decade boxes were too cumbersome and time consuming to use, causing difficulties when selecting on test.

The solution to this problem was an internal version of the C.S. units; these migrated rapidly into the development laboratory where they were found ideal for circuit optimisation. To keep up with this migration, the units have now been put into production.

Each C.S. Resistor Selector contains two decades of 2% 1/2 Watt resistors in the standard E12 range. These two decades can be

used individually, in series or in parallel. The output is on terminals to enable a further component to be connected to the circuit if required. The boxes overlap their ranges to give a maximum flexibility to the system; the four units available are from 10R to 820 R, 100 R to 8K2, 1 K to 82 K and 10 K to 820 K. Price is from £ 24.89 for 10 off and delivery is currently ex-stock.

*C.R.P. Electronics Ltd.,  
13 Hazelbury Crescent,  
Luton LU1 1DF.  
Telephone: (0582) 415832*

(2000 M)

## Portable recorder

The recently introduced type Y.E.W. 3057 recorder provides the accuracy and sensitivity of laboratory instruments in a portable recorder, with a versatility previously unavailable. Powered externally by mains or 12 V dc, or internally by dry or rechargeable batteries, the recorder can be operated in a flatbed, angled, or upright position with Z-fold or roll charts. Chart width is 150 mm with 8 chart speeds from 2 cm/hr to 60 cm/min, 12 input ranges span 10 mV to 50 V full scale, with 0.5% accuracy and 1 megohm impedance.

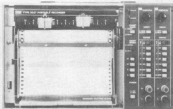

Inputs are floating and will withstand a maximum common mode voltage of 180 V with 130 dB rejection at dc or 50 Hz.

Available in 1 or 2 pen version, the instrument uses felt tip pens of a quick change design and an option provides for remote control of chart speed.

*Martron Ltd.,  
20 Park St.,  
Princess Risborough,  
Bucks.  
Telephone: (08444) 4321*

(2001 M)

## Terminal block

Designated the Series 250AE terminal block, this versatile connector offers up to eight channels. It is rated at 25 A per channel, and meets the requirements of B.S. 3456 for 16 A operation.

The 250AE terminal block is moulded in flame retardant, glass-filled polyester, and contains connector tabs of nickel- or tin-plated brass. Its design enables each channel to provide up to six terminations, and these can be combined to satisfy individual user requirements. Sixteen different termination tab styles are available and these meet virtually every interconnection standard.

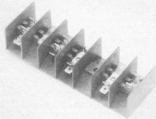

The only limit to the combinations in a given channel is governed by the use only of tabs that are physically compatible. Saddle tabs can also be provided, if required. The Series can be supplied for either end fixing or single-screw centre fixing, in conjunction with an anti-rotation pip.

*Crowdy's Hill Estate,  
Kembrey Street,  
Swindon,  
Wiltshire SN2 6BN.  
Telephone: (0793) 693681-7*

(2002 M)

## Interconnection of double-sided PCB's

Strip form track pins, which were developed and introduced by Harwin, mean PC board assemblers and home constructors can interconnect their double-sided printed circuit boards without the need for plated through holes. Now Harwin Engineers have developed a new hand tool for the quick and easy insertion strip form track pins in double-sided printed circuit boards.

The new tool feeds out the strip form track pins, exposing them one at a time so they are ready to be located in the PCB hole. When the pin has been located correctly, it is broken off the strip, leaving it in place in the hole, ready for soldering. At the press of a button, the tool exposes another pin and the process is repeated in the next hole to be connected through.



Apart from making the pin insertion process a lot quicker and easier, the new tool also ensures consistent insertion of the pin. Until now, the normal method of using the pins in strip form has been by holding the strip in the fingers. Another advantage of the new method is that the pins are kept clean during assembly prior to soldering.

*Harwin Engineers SA,  
Fitzherbert Road,  
Farlington,  
Portsmouth,  
Hants. PO6 1RT.  
Telephone: (0705) 370451*

(2004 M)

# INTRODUCING - from Elektor

## sc/mputer (2)

build your own  
microcomputer system

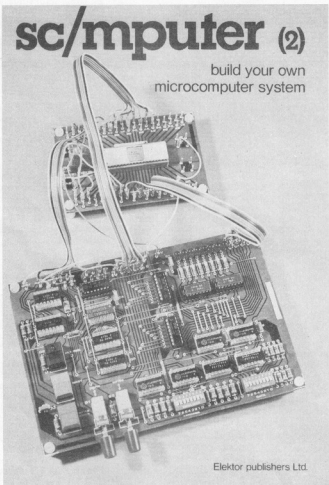

Elektor publishers Ltd.

This is the second in a series of books describing the construction and operation of a personal computer system that can be as large or as small as the constructor desires.

An updated version of the monitor program (Elbug II) is introduced together with a number of expansion possibilities. By adding the Elekterminal (ASCII keyboard and video interface) to the system described in Book One the microcomputer becomes even more versatile.

Book Two continues with a description of a BASIC interpreter (NIBL-E) and gives complete details of a basic microcomputer card which can be either incorporated into the system described in Book One or used separately.

The final chapter of the book gives all the information required to enable the Elektor computer to be programmed in the BASIC language.

## **ORDER YOUR COPY NOW**

*(available at a special low price until June 1st)*

UK .....	£3.00 inc. P&P	(after June 1st 1981 .....	£4.00)
Overseas surface mail. ....	£3.20 inc. P&P	(after June 1st 1981 .....	£4.20)

When ordering please use the Order Card in this issue

# MAPLIN make it easy...



in  
**SOUTHEND**  
284 London Road  
Westcliff-on-Sea  
Essex  
Tel: (0702) 554000  
(Closed Mondays)



in  
**HAMMERSMITH**  
159-161 King Street  
Hammersmith  
London W6  
Tel: 01-748 0926  
(Closed Mondays)

For personal service visit one of our stores.  
Our new store at Hammersmith is conveniently situated near the end of the M4 and the North and South Circular Roads.  
There is excellent street parking on meters a few steps away and Hammersmith Underground Station is nearby. Call in and see us soon.



in our  
**CATALOGUE**

320 big pages packed with  
data and pictures of  
over 5,500 items

Over 100,000 copies sold already!  
Don't miss out on your copy.  
**On sale now in all branches**  
**WH Smith price £1.**

In case of difficulty check the coupon below.

## make it easy... with MAPLIN

The  
**Maplin Matinee**

Amazing value for  
only £229.95 plus £39.50  
for cabinet if required

Easy to build,  
superb specification.  
Comparable with organs selling for  
up to £1,000. Full construction details  
in Electronics & Music Maker commencing  
March, 1981 issue. Back numbers available.



**MAPLIN** ELECTRONIC SUPPLIES LTD.

by  
**MAIL ORDER**

A fast service  
You can rely on

- ✳ Same day service on in-stock lines
- ✳ Very large percentage of our stock lines in stock
- ✳ All prices include VAT
- ✳ Large range of all the most useful components
- ✳ First class reply paid envelope with every order
- ✳ Quality components—no rejects—no re-marks
- ✳ Competitive prices
- ✳ Your money is safe with a reputable company

On price, service, stock, quality and security it makes sense now more than ever to make **MAPLIN** your first choice for components every time!

### Post this coupon now.

Please send me a copy of your 320 page catalogue. I enclose £1.25 (incl. 25p p&p). If I am not completely satisfied I may return the catalogue to you and have my money refunded. If you live outside the U.K. send £1.68 or 12 International Reply Coupons. **E6/81**

Name: \_\_\_\_\_

Address: \_\_\_\_\_

\_\_\_\_\_

\_\_\_\_\_

All mail to: P.O. Box 3, Rayleigh, Essex SS6 8LR. Tel: Southend (0702) 554155 Sales: (0702) 552911