

# elektor

up-to-date electronics for lab and leisure

62  
june 1980

ISSN 0308-308 X  
U.K. 55p.

pest pester

elektor's mosquito  
rejektor.

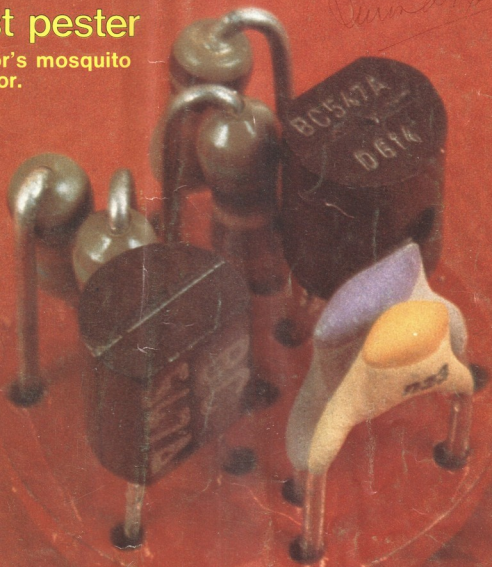

Australia \$ 1.50\*  
Austria \$ 38  
Belgium F. 63  
Canada \$ 1.75  
Denmark Kr. 10  
France F. 8  
\* recommended

Germany DM. 4.40  
Netherlands DFL. 3.75  
New Zealand \$ 1.50  
Norway Kr. 10  
Sweden F. 4.60  
Switzerland F. 4.60  
U.S.A. \$ 1.75

<b>selektor</b> .....	6-01
<b>pest pester</b> .....	6-04
Is your body itching for summer sun, while twitching at the thought of those dreaded holiday fiends: mosquitos? Do you find a couple of nights 'in the bush' are enough to turn your skin into a lunar landscape? Not to mention the sleepless hours spent wrestling with the sheets in a vain and exhausting effort to shut out that sky-diving drone? This article describes a circuit to solve your insomnia!	
<b>disco lights controller</b> (F. Op 't Eynde) .....	6-06
Disco colour light systems have been on the market for some time now. The modules have certain advantages: they're not expensive, they're easy to handle, and above all, they're safe. There is however one disadvantage: since the module is a single unit it cannot be expanded. This may be remedied by adding an extra module, as described in this article.	
<b>Ω aerial</b> .....	6-08
Readers with an interest in short wave reception, such as DXers, often have difficulty in finding a suitable aerial. The Elektor design staff have been working on this problem for some time. The result is an aerial which can be placed practically anywhere, an active aerial, which can compete with much bigger and more expensive types in the 1.8 MHz to 30 MHz range.	
<b>luxury transistor tester</b> (R. Storn) .....	6-14
<b>timbug II</b> .....	6-18
The initial design requirements for this 'bug' were that it be able to 'see' objects in its path and take avoiding action. It should also be as inexpensive and as simple as possible. As the circuit was designed around the ever popular 555 timer IC, and the circuit shown here is the Mk II version, it is not difficult to realise how it came to be christened Timbug II.	
<b>coming soon</b> .....	6-19
<b>musical cube</b> .....	6-20
<b>narrow band IF strip</b> .....	6-22
<b>more on TV games</b> .....	6-26
In earlier articles ('I played TV games', Elektor October and November 1979) we asked for our readers experiences with the joysticks — and promised to come back on the subject when we had enough data. We received several interesting reactions to this request, often including other suggestions and comments. By now, we feel that it is high time to bring all other interested readers up to date!	
<b>variable logic gate</b> (M. v. Kerkwijk) .....	6-30
<b>applikator: smoke detector</b> .....	6-32
<b>noise at high frequencies</b> .....	6-34
Noise in UHF/VHF receivers can be determined by using extensive and expensive test equipment. However, tests with a noise generator can give usable results at a much lower cost.	
<b>morse trainer</b> .....	6-35
<b>the SC/MP as a mini organ</b> (H.W. Wytes) .....	6-37
<b>the Elekterminal width extender</b> (W. Menzel) .....	6-38
<b>more on junior computer and fuel consumption meter</b> .....	6-38
<b>missing link</b> .....	6-39
toppreamp, elekterminal, active car aerial	
<b>market</b> .....	6-39
<b>advertising index</b> .....	UK 26

# contents

conten  
cont  
con

*Sum de Jongh*

**EDITOR:**  
W. van der Horst

**UK EDITORIAL STAFF**

T. Day  
P. Williams

**TECHNICAL EDITORIAL STAFF**

J. Barendrecht  
G.H.K. Dam  
P. Holmes  
E. Krempelsauer  
G. Nachbar  
A. Nachtmann  
K.S.M. Walraven



# selektor 2010101

Table 1.

	conventional incandescent lamp	Philips 'SL'	incandescent lamp with heat reflector
power rating ('wattage')	75 W	18 W	40 W
light output	900 lumen	900 lumen	900 lumen
efficiency	12 lumen/watt	50 lumen/watt	< 25 lumen/watt*
life expectancy	1000 hours	5000 hours	2000 hours*
retail price	65 p	£ 7.50	£ 2.50 ... £ 5.00
cost of lamps for 5000 hours	£ 3.25 (= 5 x)	£ 7.50 (= 1 x)	£ 6.25 ... £ 12.50 (= 2½)
electricity cost (at 3.43 p per kWh)	£ 12.86	£ 3.09	£ 6.86
total cost, 5000 hours	£ 16.11	£ 10.59	£ 13.11 ... £ 19.36

\* Theoretical maximum!

## A look on the bright side

How would you like to knock 10% off your electricity bill? It can be done, by using new lamps recently introduced by Philips!

The basic idea is quite simple. It is well-known that fluorescent lamps ('TL', in Philips parlance) are more efficient than normal filament bulbs. So what do you do? You take a miniature fluorescent lamp, fold it up, mount it in a bottle (with choke, starter and all), and add a standard bayonet (or screw) cap that fits into a normal light socket. The result (figure 1) is a direct replacement

for conventional lamps, that uses only a quarter of the electricity to give the same amount of light.

There is rather more to it, of course, but before going into technical details it is interesting to see what the new lamps can do. An 18 watt 'SL' (for 'Super Lamp?') gives the same amount of light as a conventional 75 watt bulb, and it has a useful life of more than 5000 hours - five times that of the filament type. It gives the same type of light as a normal lamp - not that nasty 'cold' white often associated with fluorescent lamps - and it starts after only the briefest of pauses, without all that irritating on/off flickering. All in all, a good and efficient replacement for conventional bulbs. But what about the price? Hold on to your seat: about £ 7.50 each!

Which brings us to the economics. You

can look at this in all kinds of way (energy saving, pounds-out-of-pocket, practical examples), but in each case the new lamp turns out a winner!

The energy aspect is illustrated in figure 2. The total energy used in an average household is shown at the left (assuming that heating, hot water supply and cooking run on gas or oil), and the electricity consumption is given in greater detail at the right. The shaded portion at the top of the 'electricity' column is what can be saved by using the new SL lamps instead of the conventional kind: more than 15%, in this case!

All right, so you can save energy. What about saving pounds - with a lamp that costs ten times as much as the normal type? This requires a little calculation, as shown in Table 1, to compare the total costs when using a normal filament

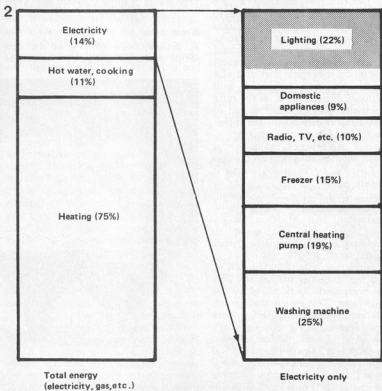
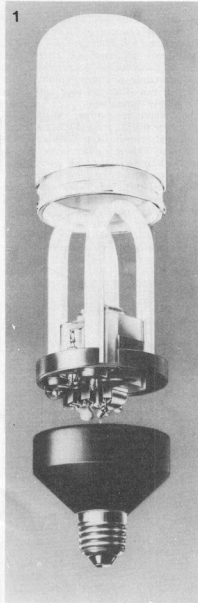

# selektor SELEKTOR

lamp, the new SL, or another new alternative proposed by Durotest and General Electric in America (amongst others): a fairly conventional filament lamp with a heat-reflective coating inside the glass. In each case, the total cost over 5000 hours is calculated — based on an electricity price of 3.43 p per unit (kWh).

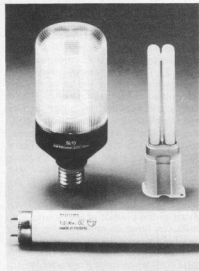

Even though the calculations are weighted against the SL (we have yet to find the filament lamp that lasts 1000 hours in a normal domestic light fitting, and the life expectancy and light output of the lamp-with-heat-reflector represent the theoretical maximum that might be achieved!), the new lamp still wins hands down. Furthermore, as the price for electricity goes up and the cost of the new lamp comes down, the difference will become even more striking. Philips give two practical examples that also shed an interesting light on the new lamp. First, as far as saving energy is concerned:

Around 1500 million incandescent lamps are sold in Europe annually. Approximately half of these are for domestic use, the rest going to 'professional' sectors (industrial, hotels and restaurants, schools, etc.). Let us now assume that, after a certain period, 10% of the consumer market and 25% of the professional is occupied by the new SL lamp. This means that, in all, 250 million incandescent lamps have been replaced by SLs — saving approximately 14.5 thousand million kilowatt hours each year, worth roughly £ 500 million! To put it another way, every family in London could light their home free of charge for 7 or 8 years, with this saving.

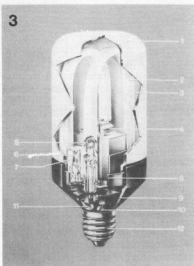

1. Outer bulb
2. Discharge tube
3. Fluorescent powder
4. Choke/Ballast
5. Electrode
6. Bi-Metallic strips
7. Starter
8. Mounting plate
9. Housing
10. Thermal cut-out
11. Capacitor
12. Lamp cap

A further example illustrates the pounds-in-pocket principle. In an average hotel, with 4000 incandescent lamps installed, about 75% of these could be replaced by 18 W SL lamps. This would give a total saving of some £ 30,000 each year!

#### A look inside

A cutaway view of one of the new lamps is shown in figure 3. As can be

seen, the fluorescent lamp itself is folded into a double U-shape, and the choke is mounted between its legs. Obviously, folding up a fluorescent lamp is no easy feat — especially since the fluorescent powder must be applied to the inside of the glass tube *before* it is heated and bent. Admittedly, Philips have a lot of experience in circular and W-shaped lamps, but even so a completely new coating had to be developed for this particular application. The fluorescent layer had to be 'strong' enough to withstand the severe bending required; it had to produce the same 'colour' as a normal incandescent lamp; and it should have the highest possible efficiency. Apparently, the designers have succeeded: the lamps are now in production!

A further problem is associated with the design target: a direct replacement for normal lamps. This limits the permissible size and weight rather drastically! As far as size is concerned, they are already quite close — as shown in figure 4. The diameter of the SL (18 W version) is 72 mm, as opposed to 60 mm for the equivalent 75 W filament lamp; the SL is 160 mm long, compared to 108 mm for its conventional counterpart. Not bad, certainly when you consider that the SL can often be used without a 'decorative' lamp shade.

The weight is another matter: 520 grams for the SL, and only 35 grams for a normal filament lamp. Over a pound! However, Philips assure us that this is still within the weight limit set by international standards for lighting fittings. One other difference, when compared to normal lamps, should be noted: SL lamps can not be operated off lamp dimmers! As with any other fluorescent lamp, they don't take kindly to a mains supply that has been chopped up by a thyristor or triac.

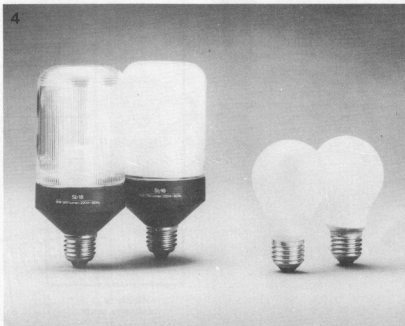

# selektor 2010

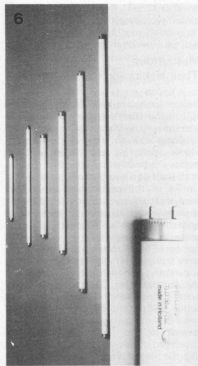
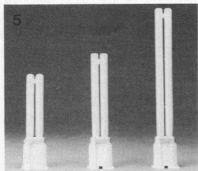

Some other lamps

At the same time, Philips have introduced some other new types of fluorescent lamp. A thing that looks for all the world like two lamps glued together at top and bottom (figure 5) goes by the name of 'PL' ('Paired Lamp?'). It is even more efficient than the SL - a 13 watt version gives the same amount of light as a conventional 75 watt bulb - and it gives the same 'warm' light.

Then there is the 'TLD' (the D stands for 'Dun', the Dutch word for thin!), once again available with the same 'incandescent lamp colour' - referred to as colour 82 (figure 6).

However, enough is enough: there is little to be gained by discussing these other types in depth.

## Design and the silicon chip

The world's first major exhibition recalling the origins of the silicon chip and tracing its development and influence in design is now open at The Science Museum, London. Intended to entertain and inform all age groups, the exhibition will continue until the end of 1980. Co-sponsored by the Science Museum, the Design Council and the Department of Industry, this is probably the first exhibition of its type to show the significance of the silicon chip in improving the quality of life for everyone.

Visitors to the exhibition will enter the first of the two halls devoted to 'The Challenge of the Chip' through a display featuring a microprocessor which is 60 times life size. Exhibits in this hall have been assembled by The Science Museum and deal with the history of the silicon chip and show its development to meet increasingly sophisticated electronic requirements.

The Design Council has selected products and systems which are impressive examples of silicon chip applications to show in the second of two halls. Products from about 60 companies are displayed in ten sections covering shopping, offices, transport, communications, production and control, education, music, medicine, home and toys.

### The chip in the home

In the future one microprocessor may control the heating and ventilation systems in the average home as well as lighting, cooking, washing, radio and television equipment. In addition, it could answer the telephone, maintain a record of telephone charges, control an alarm system, operate the curtains and do all the household accounts. For the present time designers have concentrated on utilising the inherent reliability and low cost of the microprocessor to improve existing designs of domestic appliances. The world's first computerised washing machine is on display and it uses a microprocessor to provide a more comprehensive range of washing and rinsing programmes to suit the variety of natural and man-made fibres in current use.

There is a section of the exhibition devoted to microchip controlled games and toys which will appeal to children of all ages. A popular exhibit will be the multi-loop railway with multi-control system. Computer games including chess and bridge are also on show.

### Microelectronics in medicine

Small computers, using microelectronic circuits, are now being used to help doctors diagnose complaints and store the medical records of their patients. Some examples of this equipment are shown together with new instruments, using microchip devices, which can help identify handicaps such as deafness in new born babies.

### The silicon chip in transport

Another special exhibit shows the enthusiasm with which designers at British Rail are pursuing potential applications for the microprocessor to bring about improvements in passenger travel through the more efficient issue of tickets and the provision of better passenger information facilities. The proposition that robots can be used to do all heavy work on the railways, keep trains and stations clean and move mail and parcels automatically from road to rail is being investigated. The movement of coal from the mines to the point of bulk use is already well established as an industrial conveyor belt but British Rail explains that the microprocessor could make the 'merry-go-round' completely automatic by driving the train on its closed loop journey to load and unload the coal, weigh it and produce all the necessary documents.

Fuel injection systems were one of the first of an increasing number of silicon chip applications for the motor car. A special Lucas Electrical display shows how the microprocessor can be used to conserve fuel, control exhaust emissions, monitor driving instruments and control the power delivered to the road wheels.

### Teaching machines

The ubiquitous pocket calculator is probably the best known and the most widely used microprocessor in the world. No attempt is made in the exhibition to show the tremendous variety of designs and functions of these machines. Instead there is a derivation shown which helps children learn simple arithmetic and another, based on a simple calculator, designed to encourage an interest in spelling. An ingenious information centre into which different memory capsules can be plugged to retrieve several subjects as well as different languages is shown to demonstrate the versatility, compactness and general utility of the microprocessor as a teaching aid.

### The musical chip

Microelectronics is helping to produce and reproduce music in better ways. A typical electronic organ which can simulate the sounds of many instruments and do so with a variety of accompaniments and in different rhythms illustrates the tremendous advances made in organ design since the development of the microchip. The music synthesiser is another device shown to demonstrate the remarkable possibilities which the silicon chip has brought to music.

# selektor 2010



# pest pester

Is your body itching for summer sun, while twitching at the thought of those dreaded holiday fiends: mosquitoes? Do you find a couple of nights 'in the bush' are enough to turn your skin into a lunar landscape? Not to mention the sleepless hours spent wrestling with the sheets in a vain and exhausting effort to shut out that sky-diving drone? Read on for the circuit to solve your insomnia!

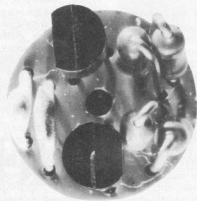

In many respects, summer can be a mixed blessing. It's wonderful to step out of the dark, dreary days of winter into the bright sunshine with holidays, parties and picnics to look forward to. At the end of the day, after a soothing shower, you slip between the cool sheets and then . . . you are rudely interrupted by that most infiltrating insect: the mosquito.

Your worries are now over! Elektor's designers have suitably sized up the situation and have come up with a sizeable solution: the Pest Pester. It couldn't be simpler or smaller. Any mosquito on the rampage will buzz off immediately upon hearing the circuit's squeak.

It is a welcome change to have such a simple, yet effective circuit fill the pages of the leading article, instead of the highly complex computer systems which usually get the honour. The Pest Pester consists of exactly nine components all told. Before dealing with the circuit's construction however, it might be a good idea to see what we're up against. How do mosquitoes 'tick'?

## Mosquitoes:

### Their Habits and Idiosyncrasies

It is common science that certain high frequency noises keep annoying insects at bay. So there's nothing new on that score. Every now and then the would-be 'inventor' of an electronic mosquito chaser allows his name to be splashed across the headlines. Invariably, though, it all boils down to the same principle.

Unlike in the past, when mosquitoes were swatted or sprayed regardless of their gender, occupation or creed, these undersized public enemies are now going to be dealt with in a biological manner. That is to say their private lives have assumed a new significance, for apparently, although they all buzz, only the females sting. Thus, these are the ones against which to take strategic action. Nature gives us another helping hand by narrowing the foe down to several million mothers-to-be. These have been discovered to avoid their men like the plague (you might have thought that the damage had already been done, but then who are we to judge the wiles of nature?). The obvious solution is therefore to reproduce the male's buzz, thereby making the bedroom a safe place to sleep in.

The next thing to consider is the frequency. All frequencies between 1 and 30 kHz were tried and the best results were obtained around 5 kHz.

## Does it work?

Can mosquitoes really be 'buzzed off' so easily? The next best thing to asking a mosquito about it, was to talk to a parasitologist. Our man was highly sceptical about it and even went so far as to say that certain tones would attract mosquitoes, rather than keep them away. We put it down to parasitical pessimism.

Another highly effective method is to use a blue light to attract mosquitoes towards a chicken wire screen where they meet an excruciating, high voltage death. Electrocution is a cruel solution. Previous high frequency devices included a 'bat simulator' (bats are renowned mosquito eaters) which, unfortunately, fooled no-one. Why use your hard earned money to buy a 'Pest Pester' when you could make it so easily yourself? Admittedly, its effectiveness remains to be proved. On the other hand, its ineffectiveness remains equally unproved. In other words, you have nothing to lose and will probably have a lot of fun in the process.

It is hoped that upon reading this article, hobbyists will eagerly produce their soldering irons and send in their empirical experiences to our editorial staff. Who knows? You might be the one to come up with the ultimate frequency!

### The circuit

Being so small and simple the 'Pest Pester' needs very little explanation. The circuit must be able to run for extended periods of time on one penlight cell (AA), it was decided.

Considerable time was spent in discussing various IC's and supply voltages, when, convinced that actions speak louder than words, one designer built an astable multivibrator (AMV) with two transistors. It used a speaker out of a telephone headset and a penlight cell for power. It worked so well that even at 0.7 volts it continued to oscillate (a remarkable feat in itself).

Figure 1 shows the schematic. Using the given values, the oscillating frequency is approximately 5 kHz. As mentioned before, this frequency seemed to be the best, but it may be changed of course by replacing R2, R3, C1, and C2 with appropriate values.

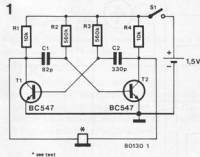

Figure 1. Schematic diagram of the Pest Pester. The telephone earpiece produces a 5 kHz tone.

A few more particulars - you may have noticed that C2 is four times larger (in value) than C1. This causes the output to have a duty cycle of around 25%. This is all quite deliberate because there will be many more harmonics in the output than there would have been at a duty cycle of 50%.

The speaker (it must be a crystal type) is connected between the two collectors of the transistors. This may seem a little strange at first, but it allows the output swing to be double the supply voltage. Some may recognise this as a sort of bridge amplifier - it is. The 'Pest Pester's' current consumption is extremely low, using only 300  $\mu$ A. This means that with a penlight battery (which is usually good for 500 mA/hr) the 'Pest Pester' will torment mosquitoes for 1500-2500 hours! Specifications like this should make them cringe.

### The printed circuit

This time we're offering two printed circuit boards for the price of one. This gives hobbyists as much freedom as possible when thinking about a case. It

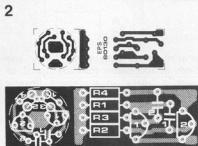

Figure 2. The two printed circuit boards and their respective parts layouts. Either the round or the rectangular circuit board may be used. Note that only the copper layer is shown at actual size: for clarity, the component layout is enlarged.

### Parts List

#### Resistors:

R1, R4 = 10 k  
R2, R3 = 560 k

#### Capacitors:

C1 = 82 pf  
C2 = 330 pf

#### Semiconductors:

T1, T2 = BC 547

#### Miscellaneous:

Crystal earpiece/speaker from a telephone headset.

comes in a round as well as a rectangular version. They are simply cut apart (they are sent as one board). Figure 2 shows both printed circuit layouts along with component positions.

All kinds of cases are suitable. The prototype was mounted in an old 'glue-stick'. The case should be large enough for the battery. For the glue-stick case, a 2 mm bolt was soldered to the copper base at the heart of the circuit board. This served as the negative battery contact.

The positive battery contact was inserted in the lid of the stick. The speaker and circuit board were placed in the bottom of the glue-stick with the

battery above. The positive lead was attached to the inside and was fixed to the top edge so that by turning the cap the 'Pest Pester' could be turned on and off. In our particular case, the glue-stick was a little too small for the speaker and the crystal had to be removed. Fortunately, this caused no problems. Figure 3 gives an illustration of this.

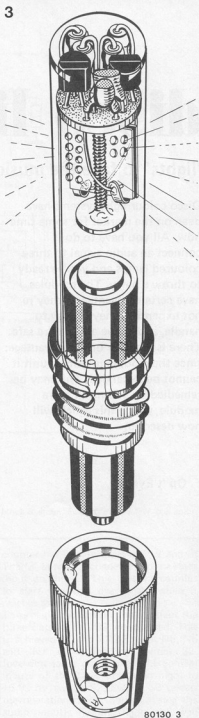

Figure 3. The entire unit may be mounted into an empty glue-stick.

A disco light system consists of groups of coloured lamps turned on and off to the rhythm of the music: red lights for the low notes, yellow for the middle notes and blue for the high notes (of course any colour may be used for any tone). In this way, the music becomes a visual as well as an aural experience. Even though this effect is fine, it comes nowhere close to that produced in a Discotheque. The lights must be able to do more than just flash with the music. This disco light module gives that little bit extra.

It is a simple circuit with which an

## How it works

Disco lights operate from an audio signal. This means that, in order to control a set of disco light, some sort of audio signal will have to be generated.

Every time the red (low) lights are to go on, a low frequency tone will have to be generated, for the yellow lights (middle) a medium frequency tone and the blue lights (high) will need a high frequency tone. For this reason, the disco light controller generates three tones: 50 Hz (low), 500 Hz (medium) and 2 kHz (high).

# disco lights controller

## 'lights' to face the music

Disco colour light systems have been on the market for some time now. All you have to do is connect an audio signal to three coloured lamps and you're ready to throw a party. The modules have certain advantages: they're not expensive, they're easy to handle, and above all, they're safe. There is however one disadvantage: since the module is a single unit it cannot be expanded. This may be remedied by adding an extra module, which this article will now describe.

existing disco light system may also flash in succession (running lights) or leave a 'space' in succession (inverse running lights) or on and off (beacon). The running speed or the flashing frequency may be varied. This unit is designed for three channel colour systems and will work on home-made or commercial models.

The block diagram of figure 1 shows the three tone generators. All three generate continuous squarewaves at the three frequencies desired. The electronic switches determine which of these (if any) reaches the output. Each of the generators has its own switch. The tone mixer also has one with which the controller can turn all the lights on and

1

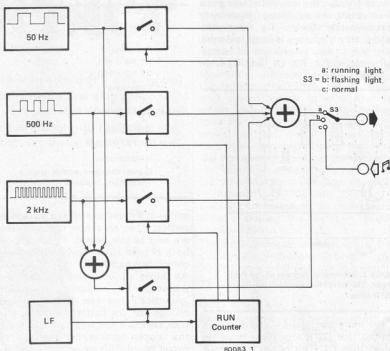

F. Op 't Eynde

Figure 1. Block diagram of the disco light controller. The device generates special tones, so that it may be used with a conventional disco light system.



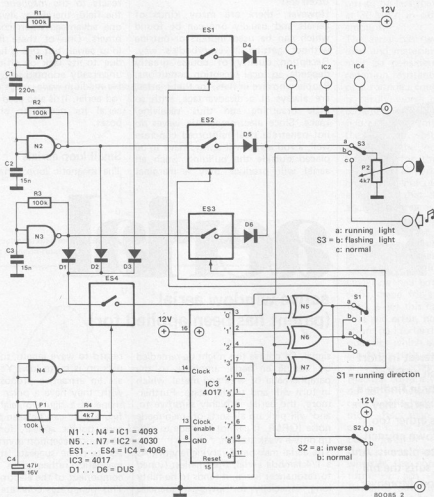

Figure 2. The schematic diagram of the disco light controller is hardly more complicated than the block diagram. Four IC's and a few 'bits and pieces' are all that's necessary.

off for the beacon function.

The electronic switches are controlled (opened and closed) by the low frequency squarewave oscillator (LF) and the run counter connected to it.

### The circuit

Figure 2 shows how figure 1 is put into effect. It is a very simple circuit with four CMOS IC's along with a few other 'bits and pieces'. The three tone generators constitute a NAND gate (from low to high: N1, N2 and N3 respectively) each. To get such a gate to oscillate, a resistor and a capacitor are added. The four electronic switches are all in one IC, so that is easy enough — ES1, ES2 and ES3 are the electronic switches for the running light and ES4 is

for the flashing light. The two mixers in the block diagram are also very simple, each consisting of only three diodes. D1, D2 and D3 mix the tones together to produce the light signal, and D4, D5 and D6 sum the output of the electronic switches to provide the running light output.

The low frequency squarewave generator is made using NAND gate N4. Its construction is similar to that of the three tone generators. The only difference here is that the resistor has been replaced by a fixed resistor and a potentiometer for varying the oscillation frequency.

The signal produced by this generator not only controls the flashing light switch ES4, but also feeds the clock input on the run counter IC3. The run

counter has four outputs 0, 1, 2 and 3. The '3' output is connected to the reset input on the IC. This tells the counter to start counting over again when it reaches three.

To provide the 'moving hole' effect the three outputs of IC3 are inverted. This is achieved by the EXOR gates N5, N6 and N7 controlled by switch S2. Inversion takes place when the control inputs of the gates are taken high, to +5V, by switch S2. Switch S3 selects the operating mode; normal (using the audio input), flashing light (the well known beacon effect) and 'running' lights. Potentiometer P2 has been included to allow adjustment of the output amplitude for matching the sensitivity of the disco light system in use.

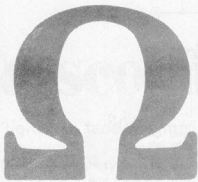

Readers with an interest in short wave reception, such as DXers, often have difficulty in finding a suitable aerial. The aerial they are really looking for is either too expensive or their town council refuses permission to place it. And a small aerial often suits the bill but not the reception. Moreover, there are few types of aerials which enable the entire short wave range to be received.

The Elektor design staff have been working on this problem for some time. The result is an aerial which can be placed practically anywhere, an active aerial, which can compete with much bigger and more expensive types in the 1.8 MHz to 30 MHz range.

The genuine DXer has a hard time these days, what with community aerial systems and local laws and restrictions. Shortwave aerials are often regarded as eye-sores — and unfortunately, they often are!

However, there are many kinds of aerials and usually one can be found which can be used indoors or outside without getting in everybody's way. Reception quality of course greatly depends on local reception conditions. People who live in flats, for that matter, are always at a disadvantage, with so little breathing and thus 'receiving' space. Since electromagnetic waves do not penetrate steel reinforced concrete well, a rod aerial will always have to be placed outside the building. Such an aerial will produce only a marginal

the best of their ability.

Of course, there are many other kinds of SW aerials, but they all manage to have one or more of the disadvantages already mentioned. An aerial which reacts to the *magnetic component* of the field, therefore, always has at least one advantage when compared to the others. One of these is the magnetic loop aerial, but this is hardly ever used due to its lack of efficiency. A type universally adopted in transistor radio's for medium wave reception is the ferrite rod aerial. It is also used as a directional aerial for navigation or military purposes.

#### Small loop aerials

The magnetic loop aerial is small with

# aerial

active window aerial  
(patent has been applied for)

signal. Of course this might be remedied by adding an aerial amplifier to the paraphernalia of wire and metal, which in turn will add to the noise. Furthermore, the aerial is highly sensitive to, and will pick up all sorts of, man-made noise (QRM). It cannot be made to pick up only a weak station.

The aerial may be of varying lengths. As a  $1/4$  lambda aerial, the smallest (tuned to resonance) aerial, it tends to be fairly long, especially for lower frequencies and in addition is tuned so that the bandwidth will be limited. The more conductive the earth under it is, the better it works as the earth serves as the dipole's counterpart.

DXers with gardens can improve the electrical quality of the earth under the aerial by digging trenches, fanning out away from the aerial and embedding copper wire in charcoal in them. When this is done the ground under the aerial will have to be kept continually moist. All in all, a job not to be taken lightly.

To the flat dweller such an installation may seem nothing more than a far fetched fantasy and he will have to make do with a tiny rod aerial. The length of the rod aerial will be many times smaller than the smallest wave length to be received and is therefore reactive (needs to be tuned to the required frequency). Now an amplifier will definitely have to be brought into the picture and fitting it between the aerial and the receiver is bound to cause quite a few problems. To make matters worse, numerous electrical appliances are used in a block of flats, all of which conspire in interfering with reception to

regard to wave length, so that its energy pick-up is quite low. Yet, these aerials are an attractive proposition. To start with, they have a polar diagram in the shape of a figure of eight as shown in figure 1. It can be seen that very sharp zero points appear, for from certain directions reception is virtually nil.

As its name suggests, it works on the magnetic rather than the electrical component of the electromagnetic field. This penetrates concrete more successfully before reaching the aerial free of interference. In blocks of flats especially, it will prove to be an asset.

One disadvantage is that the loops in use up to now have not been very successful above 7 MHz. Elektor, however, has chosen this type to work on. Considering its advantages, it is strange that so little interest has been shown in it. After all, its drawbacks (low efficiency and narrow bandwidth when tuned) should not be too difficult to solve.

It is placed in a magnetic field. With regard to the electrical field this is turned  $90^\circ$  as shown in figure 2. The aerial is therefore positioned vertically, standing perpendicular to the magnetic field as a loop. A voltage is induced in the loop which causes current to flow through the aerial and to the receiver. This naturally produces another magnetic field around the loop, so that it can operate as a receiver as well as a transmitter aerial. Part of the energy received is therefore beamed out again. You could say that part of the energy received seems to be dissipated in a resistance. This is called radiation

1

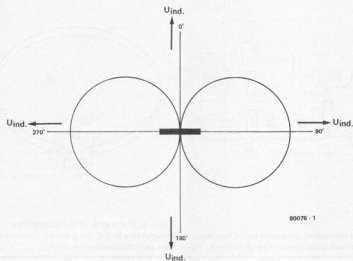

Figure 1. The directional diagram of a small magnetic loop in two dimensions. If represented in three dimensions it would resemble an automobile tyre.

2

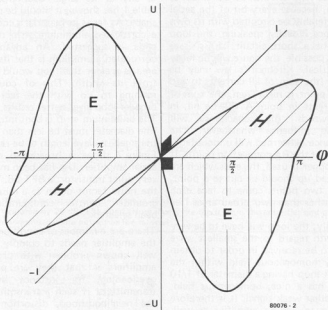

Figure 2. An electromagnetic wave consists of two main components, an electrical field and a magnetic field. This figure shows that they are  $90^\circ$  out of phase to each other.

3

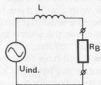

Figure 3. An equivalent schematic of a small magnetic loop antenna (or window antenna), when the current and material resistance are ignored.

4

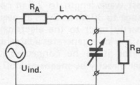

Figure 4. The equivalent schematic from the resonant loop antenna.

resistance and varies according to the aerial used.

If the average value of the radiation resistance is calculated for a loop aerial of, say, 40 cm in diameter, this turns out to be less than one tenth of an ohm at 30 MHz, in other words a negligible amount.

The aerial has two kinds of resistance: load and material resistance. The latter may be considered in series with the radiation resistance. Since the resistance of a rounded conductor of  $2\pi \times 40$  cm is hardly worth mentioning, the result obtained is the substitute shown in figure 3. The voltage source represents the induced voltage in the aerial, L stands for the inductance of the aerial and  $R_B$  for the load resistance. By means of a fairly complicated mathematical calculation, it may now be established that the smaller the inductance the greater the current passing through the aerial. At the same time, the greater the flux contained the greater the current. Thus, it is safe to say that the aerial with the highest possible  $\Phi/L$  ratio is the best one to use.

Once we had got that far, finding the right shape for the aerial was chicken feed. Since this had to be a question of trial and error, however, a few considerations had to be dealt with first. The frequencies which we are concerned with are fairly high, so the 'skin' effect will arise to a certain extent. (This means that the current will mostly flow to the outside of the conductor). This being the case, a solid rod of copper will have no more effect than a hollow drainpipe. In addition, the fact that the current will pass through the outside of the conductor will really make it immaterial whether the conductor has a tubular form or not. In fact, it could be flattened out, thereby creating a thin, flat conductor.

A few measurements proved this point. Hardly any difference in self-induction between the thin sheet copper and a hollow tube or massive rod was noted. Thus, the obvious conclusion was to stick to the thin sheet copper for further measurements, since this can be bent into all sorts of shapes. The results of tests carried out on various shapes are given in table 1. Note how a broad loop aerial (14) produces better results than a large, narrow specimen (10). The ratio of the aerial loop's surface area to self-induction was used as a criterion.

Another point of interest in this table is the fact that six loops wired in parallel (25) also produce very low self-induction. This may be explained as follows. If two coils are wired in parallel, the value of self-induction will be halved. But this will only occur when the coils do not affect each other and do not generate mutual induction voltages. When broad foil is used, there will also be a number of coils switched in parallel, but these do affect each other. This is only partly prevented by foil, with the result that the self-inductions present are

5

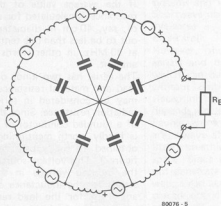

Figure 5. When the loop is divided into small sections, the equivalent schematic looks like this. When the current flow at point A is nil (Kirchhoff) the various capacitances can be ignored.

more significant than is the case in 25. The ideal distance between loops has been found to be about a tenth of the diameter of the loops. Nevertheless, copper foil is the best choice, because the aerial then takes up less space and is easier to construct.

There are two types of magnetic loop aerial: a resonant and a non-resonant type. This is determined by whether the aerial has been tuned or not. The resonant type uses the layout in figure 4. As a capacitor has now been placed in parallel to the load, the reactance of the aerial is 'tuned out'. It should be noted that whether or not one half of the power is re-radiated depends on the type of matching, i.e. power matching noise matching. The advantage of this type of aerial is that more power is available as compared with the untuned version.

A drawback is that the aerial is narrow banded and must therefore be tuned. If it is to be placed in the attic or on the roof this will have to be done by remote control, which is easier said than done. Secondly, the current through the aerial will be  $90^\circ$  out of phase with the flux, thus with the  $\Phi$  in figure 2.

An advantage, on the other hand, is that its transmitter and receiver characteristics are equal, so that a fairly mobile transmitter/receiver aerial is obtained with the directional characteristics of a dipole.

The small loop aerial is non-resonant. This means that the transmit and receive capabilities are not the same. As the aerial we are looking for has to suit the average short-wave listener, this is of minor importance.

### The $\Omega$ aerial

For every unit of length any conductor will have a certain amount of inductance and capacitance. Usually, the capacitance is disregarded, but since a loop aerial's width is equal to its length, it will have to be taken into account here. Let's take a look at the replacement

layout. Since inductance can be established per unit of length, it can be assumed that the layout will look like figure 5. It now follows that load resistance  $R_B$  should be as small as possible, because every bit of the aerial will preferably be circuited with its own impedance. Ideally speaking, the loop should be a short circuit. If  $R_B$  is as small as possible, the figure will be fairly symmetrical. Kirchhoff's law may be applied (the sum of all currents to and from a point is nil). Then, the sum of the currents in point A will be nil, in other words: the capacitance will have no influence whatsoever. The capacitance concerned will undoubtedly come up at the  $R_B$  connection points. If sheet copper is used, the ends which are connected up should be cut to a point, so that two points come to face each other rather than two broad areas (see figure 6).

Optimally, the loop will have to be very small with regard to the smallest wave length to be received in order to obtain a highly homogenous field within the aerial. A loop having a diameter of  $1/10$  lambda has a nice, homogenous field, but a rather weak signal. It is therefore advisable to use an amplifier as well. This must be virtually free of noise with a very low input impedance and be as well matched as possible to the first receiver stage. If necessary, a less homogenous field will suffice and the diameter may be increased to  $1/4$  of the smallest wave length to 2.5 m covering the range to 30 MHz. Such an aerial will also partly react to the electrical field, but in any case generates a large enough signal for it to be connected to the receiver directly by means of a 50 - 70  $\Omega$  cable.

### The active $\Omega$ aerial

Gradually we are getting to the crux of this printed matter! After all, what it is all about is how to construct an aerial which is suitable for short-wave listeners

6

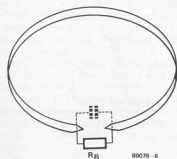

Figure 6. If the ends of the antenna are brought to a point, the parasitic capacitance is kept to a minimum.

(SWL's) and easy to set up. We have opted for the non-resonant magnetic loop aerial with amplifier. It will be small in size, easy to build and as good as any of its larger counterparts. As table 1 has shown, it should be round in shape. As far as its material is concerned, a corrugated aluminium strip three cm wide is suggested. An advantage of corrugated aluminium is that its surface area is greater than you would imagine from its width. This of course has nothing to do with the fact that a broader loop gives better results.

The aluminium strip is bent into a loop. The diameter must be less than  $1/10$  of the smallest wave length to be received. Figure 7 shows a broadband noiseless aerial amplifier. Use has been made of a very quiet transistor: a BFT 66. To keep the noise factor down to a minimum a grounded emitter configuration has been selected.

There are a number of conditions which the amplifier needs to comply with. A well known problem with broadband amplifiers is that they are prone to overloading, for instance by local transmitters. If such a transmitter is in the neighbourhood, distortion in the amplifier stage may cause the signal to mix with the other two signals and to produce a mixture product within the tuning range of the receiver. As a result, 'stations' are heard where they do not exist, and existing weak stations are inaudible. This can be avoided by using an amplifier with a wide dynamic range. Furthermore, the amplifier's bandwidth will have to cover the entire short wave range and, of course, the noise it produces itself will have to be negligible. At a collector current of 9 mA the BFT 66 has its maximum dynamic range (approximately 60 dB). Resistors R1, R2, R3 and diode D1 take care of the bias, resulting in 9 mA of collector current. The (unby-passed) emitter resistor R1 creates a small amount of feedback, improving the amplifier's IMD properties at the expense of the noise

7

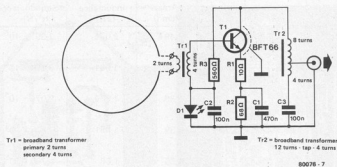
Figure 7. The broadband amplifier for the  $\Omega$ -antenna.

8a

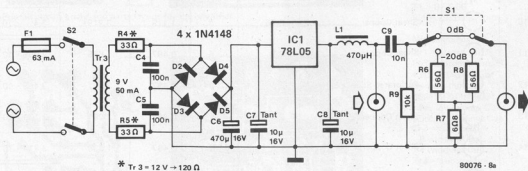

Figure 8a. The power supply for the antenna. When S1 is switched in the lower position, the input is attenuated by 20 dB. The open arrow shows the input from the amplifier and the shaded arrow represents the output to the receiver.

8b

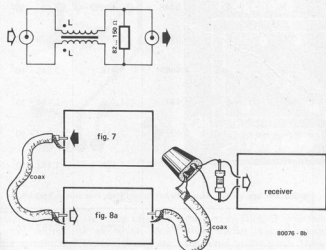

Figure 8b. To avoid any possibility of oscillations, the power supply is placed between the amplifier and the receiver. The two coils in the above drawing consist of 10 to 20 windings of 0.2 mm enameled copper wire.

figure. If a larger aerial loop than 50 cm is chosen, the effect obtained will be partly nullified. Since the collector and base impedances are highly reactive oscillations are likely. Thus it is important to work out the component layout in such a way, that the connections between the various components are as short as possible. In addition, the input and output will have to be as far away from each other as possible.

In the design of the amplifier a compromise was reached, this being that the aerial is not low-impedance terminated. The result is that the signal production at lower frequencies drops by 6 dB per octave. This is no disaster, because as the noise at lower frequencies increases up to 20 dB per octave, the net result or signal to noise ratio will at any rate not deteriorate. This means that the receiver's dynamic range meets more

flexible demands than when an active rod aerial is applied, which was seen to amplify the total signal + noise factor at lower frequencies as well.

The amplifier printed circuit board has been designed to form a unit with the aerial. The supply for the amplifier, which has been included on a second printed circuit board, can be connected to the amplifier by means of a coax cable (see figure 8a). It is advisable to place the aerial several metres away from the receiver to reduce any risk of oscillation to a minimum and care must be taken that the receiver and aerial are not placed on the same metal base. (Oscillations may be recognized as an inordinate amount of noise emitted by the receiver). In figure 8b a method is shown to eliminate oscillations by a sort of balun between the output of figure 8a and the receiver.

**Last but not least . . .**

After reading the information provided in this article, it should be possible to build a good aerial which can be put up

























Aerial Number	Form	Material	Loop Lnth. (m)	Width (cm)	Area (cm <sup>2</sup> )	inductance (μH)	area/inductance (m <sup>2</sup> /H)
1		Sheet Copper	2,5	3	0,497	2,075	2,397 · 10 <sup>5</sup>
2		Sheet Copper	2,5	3	0,4499	1,961	2,294 · 10 <sup>5</sup>
3		Sheet Copper	2,5	3	0,39	1,879	2,076 · 10 <sup>5</sup>
4		Sheet Copper	2,5	3	0,39	1,851	2,107 · 10 <sup>5</sup>
5		Sheet Copper	2,5	3	0,30	1,68	1,786 · 10 <sup>5</sup>
6		Sheet Copper	2,5	3	0,30	1,643	1,826 · 10 <sup>5</sup>
7		Sheet Brass	2,5	3	0,497	1,972	2,52 · 10 <sup>5</sup>
8		Sheet Copper	2,04	3	0,331	1,595	2,076 · 10 <sup>5</sup>
9		Sheet Copper	3,06	3	0,745	2,615	2,849 · 10 <sup>5</sup>
10		Sheet Copper	3,75	3	1,119	3,2191	3,4 · 10 <sup>5</sup>
11		Sheet Copper	2,5	6	0,497	1,665	2,985 · 10 <sup>5</sup>
12		Perforated Sheet Copper	2,5	3	0,497	2,021	2,459 · 10 <sup>5</sup>
13		Sheet Copper	2,5	1,5	0,497	2,291	2,169 · 10 <sup>5</sup>
14		Sheet Copper	2,5	12	0,497	1,338	3,714 · 10 <sup>5</sup>
15		Sheet Copper	2,5	2,25	0,497	2,079	2,39 · 10 <sup>5</sup>
16		Sheet Copper	2,5	9	0,497	1,470	3,38 · 10 <sup>5</sup>
17		Sheet Copper	2,5	4,5	0,497	1,827	2,72 · 10 <sup>5</sup>
18		Sheet Brass	0,75	40	0,0448	0,1825	2,45 · 10 <sup>5</sup>
19		Sheet Brass	0,41	20	0,01337	0,748	0,178 · 10 <sup>5</sup>
20		Sheet Brass	≈ 2,5	3	0,4499	1,918	2,345 · 10 <sup>5</sup>
21		Coax Cable	2,5	—	0,497	1,705	2,194 · 10 <sup>5</sup>
22		Waterpipe	2,5	1,6	0,497	2,115	2,349 · 10 <sup>5</sup>
23		Aluminium Section	2	3,9	0,318	1,458	2,183 · 10 <sup>5</sup>
24		AC powercord	2,5	0,1	0,497	3,18	1,562 · 10 <sup>5</sup>
25		Six AC powercords in parallel	2,5	6 x 0,1	0,497	1,569	3,167 · 10 <sup>5</sup>

Table 1. This table shows the various results obtained with different antenna sizes and materials.

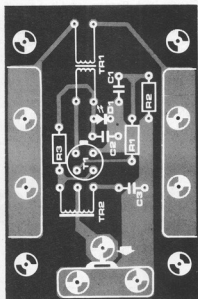
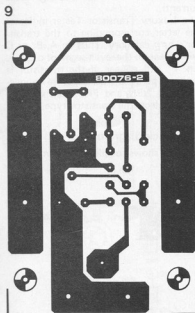

Figure 9. Printed circuit board and parts layout for the amplifier.

Parts List for figures 7 and 8.

- Resistors:  
 R1 = 10 Ω  
 R2 = 68 Ω  
 R3 = 560 Ω  
 R4, R5 = 33 Ω (by use of a 12 V transformer 120 Ω)  
 R6, R8 = 56 Ω  
 R7 = 6Ω8  
 R9 = 10 k

- Capacitors:  
 C1 = 470 n  
 C2, C3, C4, C5 = 100 n  
 C6 = 470 μ/16 V  
 C7, C8 = 10 μ/16 V tantalum  
 C9 = 10 n

- Semiconductors:  
 D1 = LED (red)  
 D2 . . . D5 = 1N4148  
 T1 = BFT 66  
 IC1 = 78L05

- Miscellaneous:  
 Tr1 = ferrite coil  
 Philips order number:  
 4312-020-31521 or  
 Siemens number:  
 B62152-A004-x001  
 Pri, 2 windings CuL  
 Sec. 4 windings CuL  
 Tr2 = ferritbead  
 8 windings CuL  
 4 windings CuL  
 Tr3 = transformer  
 sec. 9 V/50 mA  
 or 12 V/50 mA  
 L1 = 470 μ  
 S1 = 220 V DPST  
 S2 = DPST  
 F1 = Fuse 63 mA.

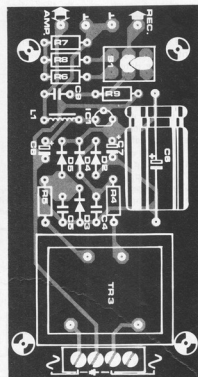
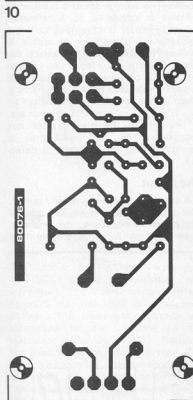

Figure 10. Printed circuit and parts layout for the power supply and attenuator.

in any house or flat. In cases of great difficulty, copper or aluminium foil may be chosen and the aerial may be fixed flat against the inside of a cupboard door. The aerial is then directionally mobile and will not be in anyone's way. One thing which must be taken into account is that any metal surfaces must be removed from around

the aerial. Thus, if your windows have metal frames, it is not a good idea to fix the aerial to the pane. Then it is indeed better to use a cupboard door. Of course, by applying several loops, the aerial's directional effect may be increased. One way is to place two loops next to each other (keep in mind that the individual distance must be at least

1/10 of the diameter of the aerials to keep coupling between them low). If the SW receiver has a battery supply, so that DXing may be continued out and about, it is possible to derive the supply from the receiver or use a battery exclusively for the Ω aerial. The supply voltage of the amplifier may be between 4 V and 12 V.

This particular design first appeared on Elektor's pages in last year's Summer Circuits issue. Readers voted it as one of the most interesting circuits and this article is the elected Elektorised result. The circuit has been slightly modified and a printed circuit board now accompanies it.

In technical literature, the current amplification is usually indicated as  $h_{FE}$ . For everyday purposes it is not absolutely necessary to know the precise  $h_{FE}$  value, but rather to have a rough idea of its upper and lower limits. The manufac-

ture used to have no way of precisely determining the current amplification ratio in advance. The best he could do was make a rough estimate, then after the transistors are manufactured, they were selected to meet the required  $h_{FE}$  limits. The type number was then printed on the case. Although nowadays this can be determined in advance, the same type numbering is still used. Two transistors with the same type number do not necessarily have the same  $h_{FE}$ . That is why industry uses a letter as a suffix to indicate the general  $h_{FE}$  value. The letters define the  $h_{FE}$  according to the following values:

'A' for an  $h_{FE}$  between 140 and 270  
'B' for an  $h_{FE}$  between 270 and 500  
'C' for an  $h_{FE}$  of more than 500

The terms  $h_{FE}$  and current amplification ratio describe the ratio between

$I_c$  (collector current) and  $I_b$  (base current).  
The Luxury Transistor Tester indicates the letter corresponding to the transistor's  $h_{FE}$  category. Thus an A, B, or C will appear on the seven-segment display. An 'F' will appear, if the transistor is faulty. The circuit has separate connections for NPN and PNP transistors. A switch selects the transistor type.

### The block diagram

Figure 1 shows the block diagram of the

# luxury transistor tester

A highly important aspect of transistors is their current amplification ratio. This is often indicated by an A, B, or C behind the type number in the case of transistors. Inevitably however (by decree of Murphy himself), this is no longer legible. Using the transistor tester described here, the correct letter can be read from a display. At the same time, it can also be determined whether the transistor is up to scratch or not.

R. Storn

transistor tester. Its operation is quite simple. The voltage across a number of resistors is compared to a reference voltage. Here it is important to know beforehand whether the transistor is NPN or PNP. The switch that selects the transistor group also operates an LED to indicate the position of the switch. This voltage comparison determines the  $h_{FE}$  group of the transistor and displays an 'A', 'B', or 'C' whichever is appropriate. If the 'F' on the display does not disappear when the pushbutton is depressed, then the transistor is defective.

### The layout

The complete layout is given in figure 2. Also shown is the parts list. The schmitt triggers in the block diagram consist of three op-amps wired as comparators.

1

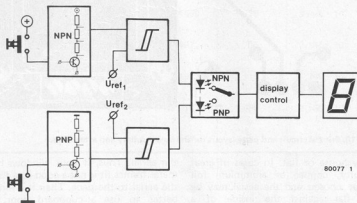

80077 1

Figure 1. The block diagram of the Luxury Transistor Tester.



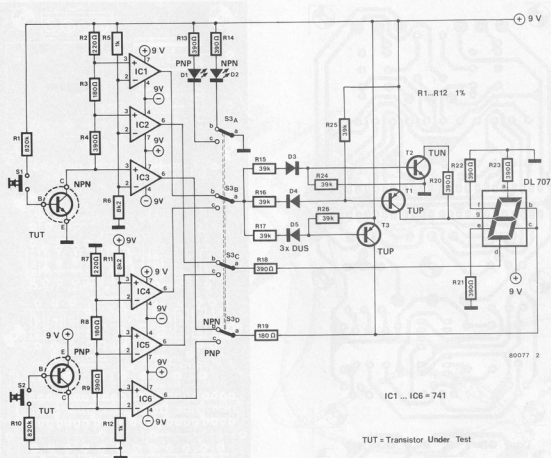

Figure 2. The complete schematic of the Luxury Transistor Tester. The design has undergone some changes since the 1979 Summer Circuits issue when this transistor tester was first published. Diodes D3 to D5 and R24 to R26 have been added along with a split supply. The diodes protect transistors T1 - T3 from high voltages that may show up at the base-emitter junction.

The upper half of the schematic, IC1 - IC3, serves to measure NPN transistors. The inverting inputs of the op-amps are connected to a reference voltage. The non-inverting inputs are connected to the collector of the transistor under test (TUT). Resistors are used as voltage dividers here. The base drive current is determined by R1 and R10. At a certain amplification factor the collector current will also be fixed. Then the three collector resistors will be under a voltage determined by the current amplification ratio and the value of the collector resistor. If the amplification factor is 400 and the base drive is 10  $\mu$ A, then the collector current will be 4 mA. With this amount of current flow, the voltage dropped across the collector resistor R4 (390  $\Omega$ ) will be 1.56 V. Three collector resistors have been included and they all have a certain voltage dropped across them. In the given example, R2 (220  $\Omega$ ) has 0.88 V and R3 (180  $\Omega$ ) has 0.72 V. As

said earlier, R4 has 1.56 V dropped across it. This makes calculating the voltages at the IC inputs easy. The inverting inputs are all at the same potential (or voltage). The voltage at the TUT's collector will be 9 V - 3.16 V = 5.84 V (the 3.16 V is the sum of the voltages across the resistors that feed the non-inverting inputs and the 9 V is the supply voltage). The reference voltage at the inverting input is 8.02 V which is determined by R5, R6 and R11, R12. In the earlier stated example, therefore, IC3's output will be low along with IC2's. Only IC1's output will be high. This is shown by this simple calculation:

9 V (supply) - 0.88 V (voltage at pin 3) = 8.12 V. 8.12 V is higher than the 8.02 V reference. If S3 is in the NPN position a B will appear on the display. If the output of IC1 were also to go low, the display would then be C. This would be correct as the voltage drop across the resistors would have risen as well as the

current through them. The base current in this circuit being always the same, the higher collector current could only be due to a higher current gain.

If, on the other hand, the outputs of IC1 and IC2 were high, only segment d would not light and so an 'A' would appear on the display. Segments a, e and f are always on because they're used in all of the various letters that are displayed. All of the above is on the presumption that the transistor is not faulty, for if it is, then an 'F' will appear. This occurs only when all the IC outputs are high - when the reference voltage is higher than the collector voltage of the TUT.

The display control (the circuit consisting of T1, T2 and T3 along with resistors R15... R19, R24... R26 and diodes D3... D5) works quite simply. If the outputs of IC2 and IC3 are low, segments d, b, and c of the display are lit. The common anode of the display is, of course, always connected to the +9 V

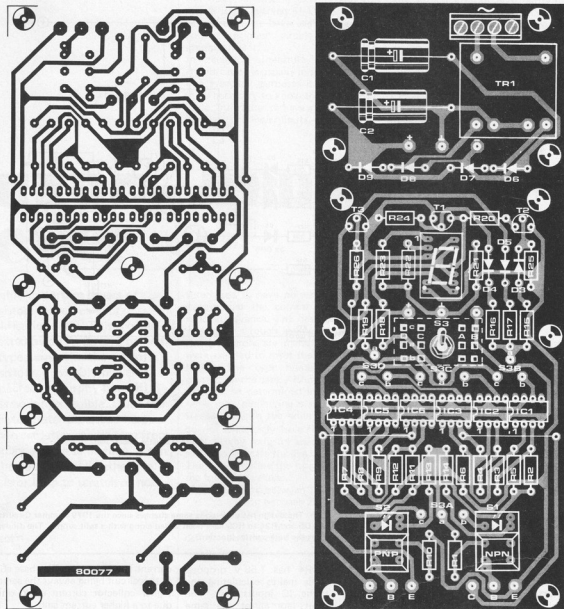

Figure 3. Printed circuit layout.

## Parts List

## Resistors:

R1, R10 = 820 k  
 R2, R7 = 220  $\Omega$   
 R3, R8, R19 = 180  $\Omega$   
 R4, R9, R13, R14, R18, R20, R21,  
 R22, R23 = 390  $\Omega$   
 R5, R12 = 1 k  
 R6, R11 = 8k2  
 R15, R16, R17, R24, R25,  
 R26 = 39 k

## Capacitors:

C1, C2 = 1000  $\mu$ /16 V

## Semiconductors:

IC1 ... IC6 = 741 (Mini-DIP)  
 T1, T3 = BC 557B  
 T2 = BC 547B  
 D3, D4, D5 = 1N4148  
 D6 ... D9 = 1N4001  
 Dp1 = LED-Display DL 707

## Miscellaneous:

Tr = sec, 2 x 6 ... 9 V/50 mA  
 S1, S2 = Digitast and LED  
 S3 = 4 pole two way  
 Verocase 502 (75-3960E)  
 of similar

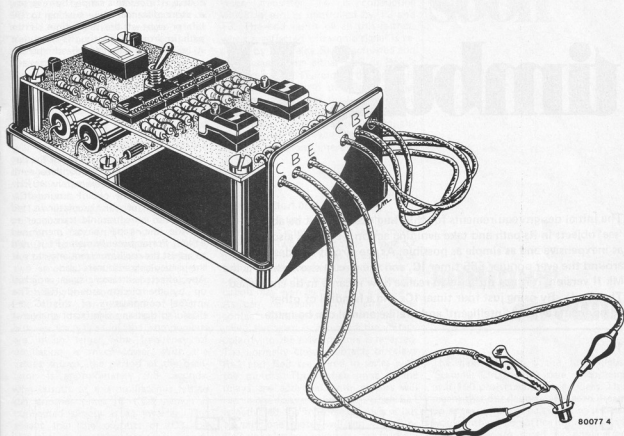

Figure 4. If the plastic case, that is mentioned in the text, is used, the whole transistor tester can be fitted into one case. Both of the LED's are mounted in the pushbutton (digitast) switches.

supply.

IC1 controls the three transistors. If IC1's output is high, only T2 will conduct so that segment g is connected to ground. Conversely, if IC1's output is low then only T1 and T3 will conduct with the result that segments b, c, and g are connected to +9 V and these segments go out.

A similar situation occurs when S3 is changed to the PNP position. The outputs of IC4, IC5 and IC6 are then connected to the display instead of IC1, IC2 and IC3.

### Construction

In figure 3, both sides of the printed circuit are shown. To make construction as easy as possible, the display and switches have been included on the board. Even the transformer can fit on

it if a board mounting type can be found, otherwise a little tinkering may be necessary. The connections between the supply and the circuit itself have been deliberately omitted. This makes it possible to cut off the supply portion of the printed circuit board and mount it above (or anywhere else for that matter) the main board. The entire unit can be mounted in a Verocase type 502 (75 - 3960 E) or similar. Figure 4 shows how this is done.

Switch S3 is a 4 pole 2 way and, if desired, can be attached to the printed circuit board. For this, a hole may be drilled into the board and the tumbler can be inserted without any difficulty. If this is done it should be possible to make a slot in the case's lid so that S3 may be operated. The switch's connections must be wired to the circuit board. On the printed circuit the various

connections have been marked in the same way as the switch in the parts list. Pushbuttons used to interrupt the base drive of the TUT should be of the digitast type. Below S2 are the connections for the PNP and below S1 those for the NPN. The pin assignment code is C = collector, B = base and E = emitter.

The IC op-amps are the popular (and inexpensive) 741 type. There is however one minor disadvantage to this, six IC's are necessary. By avoiding the use of IC sockets (not needed in this case) costs can be kept to a minimum. It is however advisable to use a socket for the display. The transistors to be tested should, ideally, be connected to the board by means of clip leads. If this proves impossible, a transistor socket may be used, but this has shown disadvantages in practice.

# timbug II

The initial design requirements for this 'bug' were that it be able to 'see' objects in its path and take avoiding action. It should also be as inexpensive and as simple as possible. As the circuit was designed around the ever popular 555 timer IC, and the circuit shown here is the Mk II version, it is not difficult to realise how it came to be christened Timbug II. By using just four timer ICs and a handful of other components a quite 'intelligent' and lifelike animal can be made.

Rather like a bat, the bug transmits a 'radar beam' of ultrasonic sound which will be reflected by any obstacle in its path. Once this reflected signal has been detected the bug will alter its course. It does this simply by reversing a short distance while turning to the left or right at the same time. If the path in front of the bug is now clear it will move straight ahead thereby avoiding any obstacle. If, however, another object is detected the bug will continue to 'wriggle its way out' by turning to the left and right alternately.

## Circuit diagram

The complete circuit diagram of the bug is shown in figure 1. An oscillator with a frequency of approximately 40 kHz is formed by the circuit around IC1. The output of this oscillator is fed directly to an ultrasonic transducer to provide the 'radar beam' mentioned earlier. Preset potentiometer P1 is used to adjust the oscillator frequency to suit the particular transducers used. Any reflected ultrasonic signal is picked up by the circuit around IC2. The internal comparators of this IC are biased so that any significant change at

1

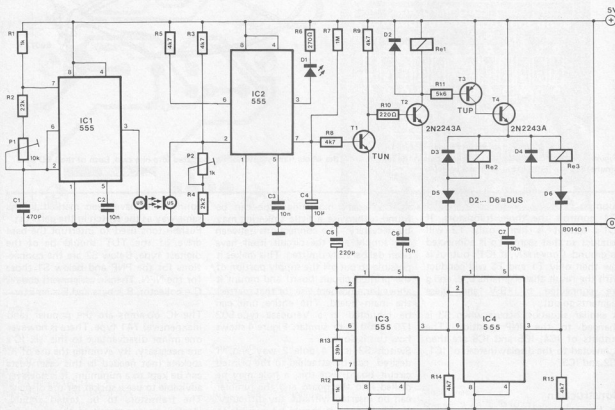

Figure 1. The circuit of Timbug II uses very common components — nothing critical.

the input (pin 2) is detected and, as the IC functions as a window discriminator, a large voltage swing is produced at both outputs. One of the outputs is connected to an LED (D1) which will appear to be 'on' when a signal is being received - it will of course be turned on and off at the same rate as the input frequency. The 'sensitivity' of the detector circuit is determined by the setting of P2.

Resistor R7 and capacitor C4 provide a simple filter for the second output of the detector circuit. As soon as a reflected signal is detected this output will go low thereby discharging C4 and turning off transistor T1 which, in turn, will turn on transistor T2 to activate relay Re1. This relay has two sets of changeover contacts which are wired so that when operated they will reverse the voltage polarity to the drive motors. Re1 will remain activated until the voltage on C4 reaches a level high enough to turn on T1 and so turn off T2. Due to the time constant of R7/C4, the relay will remain activated for about two seconds after the detected signal has gone, that is when there is no longer an obstacle in the path of the bug.

The circuit configuration of IC3 is similar to that of the transmitter (IC1) but, as the values of the components are much larger, the frequency of oscillation is much lower. With the values shown, the period of the oscillator is approximately 9.8 seconds. The output of this oscillator is fed to yet another timer IC (IC4) which is connected simply as an inverter. This means that the outputs of IC3 and IC4 provide two low frequency signals which are 180° out of phase with each other. These two outputs control the 'left' and 'right' relays (Re2 and Re3 respectively) each of whose normally closed set of contacts are wired in series with one of the drive motors. Diodes D5

and D6 are included so that there can be no feedback between the two outputs which could cause both relays to be activated at the same time.

As it is, the relays can only be activated when transistor T4 is conducting which in turn is controlled by T3 and T2. The end result of all this is that, when a reflected ultrasonic signal is received by IC2, relay Re1 is activated and at the same time either Re2 or Re3 is also activated. Therefore, the bug will reverse and turn in the direction dictated by the state of the low frequency oscillator IC3. If, of course, IC3 changes state while T2 is still conducting, the direction of turn will also change - making for more interesting and life-like results.

### Construction and setting up

The circuit for Timbug II can be incorporated into virtually any model which has two drive motors - one for each wheel - and a single castor type front (or rear) wheel. As direction is controlled by the two drive motors, the circuit may even be built into a tank.

As can be seen from figure 2, the contacts of relay Re1 are wired so that when the relay is activated the voltage polarity to the drive motors is reversed. The normally closed contacts of relays Re2 and Re3 are wired in series with the motors. Thus, when none of the relays are activated both motors will run in the forward direction. When Re1 is activated the motors will reverse but as only one motor will run - Re2 or Re3 will also be activated - the bug will turn away from the obstacle.

The setting up procedure for the unit could hardly be simpler and requires no special test equipment whatsoever - not even to adjust the transmitter frequency! Initially P2 is adjusted so that LED D1 turns ON and then carefully readjusted so that the LED turns OFF but is close to the point of coming ON. With an object placed a few centimeters in front of the bug's 'eyes', P1 is adjusted until LED D1 lights. P2 may require some readjustment but normally the object can be moved further away and P1 adjusted until the required 'seeing distance' is obtained. ■

2

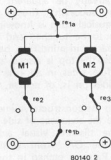

Figure 2. Timbug II uses two motors controlled by three relays and these are connected as shown here.

# coming soon

## summer circuits

The next Elektor is the July/August 'Summer Circuits 80' issue. It contains over 100 projects and design ideas. This means that our design staff has to dream up as many new circuits for one issue as would otherwise suffice for the whole year. Some are based on application notes, others on ideas sent in from readers, but all are interesting or exceptional in one way or another. The editor demands that the circuits should be 'new', 'original', and/or 'different'. The head of design demands that they work, and the deputy editors for the various editions demand that the components should be available.

From missile attack games to melody makers. From video pattern generators to wind detectors.

Some are basic design ideas, others are completed circuits. Some come with printed circuit layouts too. All promise to be interesting!

# more than 100 circuits in one issue!

# musical cube...

Having a somewhat weird sense of humour, a certain member of the Elektor design team (who shall be nameless) has come up with this rather novel circuit. When friends come round for drinks and a chat it is no longer necessary to stare at each other in total silence while one of you thinks of something to say. With the musical cube sitting on the coffee table you have a ready-made conversation piece. 'What's that?' they say. 'What's what?' you say. 'That thing there!' they say. 'That's my pet musical cube' you say, 'he sings!'. Say no more, the evening is off to a flying start. You then go on to explain that you are the only person able to control its rather nasty temper. To prove it you talk quietly to the cube and it will 'sing' its reply. You then pick the cube up and move it to a different place in total silence. The guest is then invited to move the cube back in a similar manner. The cube, of course, not being used to the new scent, will complain bitterly.

How is it done? Easy, four of the five sides (not the base — even a cube has to have something to sit on!) are touched in a certain sequence. As the owner/trainer of the cube knows the sequence there is no problem. As each side is touched the cube will produce a tone and when all four sides have been touched in the correct order the cube will remain silent. If, however, one of the sides is touched out of sequence the cube will produce a horrible noise to show its disapproval. The odds against a newcomer hitting upon the correct sequence at the first attempt are, of course, very high.

## Circuit

The circuit diagram of the musical cube is shown in figure 1. It may seem a bit complex at first sight but its operation is fairly straightforward. It works on the 'vicious circle' principle. Initially everything is reset. The outputs of N1, N3, N5 and N7 are all low, while the outputs of their counterparts (N2, N4, N6 and N8) are all high. As IC1 is reset each of its outputs is low — note output '0' is not used. Because all inputs to the EX-NOR gates (N10...N13) are the same (low initially) all of their outputs will be high. This in turn means that the output on N14 will be low. The Q output of IC3a is low so that the oscillator formed by N19 will be inhibited. The output of N19

will of course be high so that N20 is enabled.

Now for the juicy bits... Each of the points marked A...D are connected to four of the sides of the cube (we count the top of the cube as being one side). The cube can be made from single or double sided copper clad board suitably etched to provide a touch sensor. Each of the connected sides has to be touched in the sequence A, B, C, D. It is left to the constructor to decide which of the sides will correspond to A etc. When the first side is touched the flipflop formed by N1/N2 will change state. The output of N2 will go low providing one of the inputs of N9 with a negative going pulse via C4. The output of N16 will therefore go low for the same duration. This output has a dual function. Firstly, it triggers IC4a which, via N17, removes the reset from the oscillator formed by IC2. Secondly, via N20, it provides a clock pulse for IC1. This means that the first output of IC1 will go high turning on transistor T1 so that IC2 oscillates at the frequency determined by the values of R13 and C7. Both inputs of N10 will now be high so its output is still high and the output of N14 will still be low. The network R10/C5 takes care of propagation delay problems and ensures that IC3a is not triggered at this time. The 555 oscillator (IC2) will produce a tone via the loudspeaker for as long as the Q output of IC4a remains low — just less than half a second with the values shown.

The same will happen when side B is now touched with the addition that the first flipflop is reset by the output of N4. And so on along the line until side D is touched. This being the last side in the sequence it is assumed that having got this far everything is OK. The output of N15 will now go low and C6 will start to discharge. When C6 is sufficiently discharged the output of N18 will go high and trigger IC4b. This slight delay is incorporated so that the system will not reset before the last tone is heard.

Both outputs of IC4b are used to reset the entire works. The Q output resets all the flip-flops, while the Q output is used to reset the counter (IC1). This reset condition lasts for around 10 seconds — more than sufficient time for the owner/trainer to move the cube.

So far so good. We have dealt with correct operation, but what happens when one of the sides is touched out of sequence? The counter will still be clocked and a tone will be produced from the 555 oscillator — albeit very briefly. However, the inputs to two of the EX-NOR gates (it doesn't matter which two) will now be different. This means that their outputs will go low taking, in turn, the output of N14 high. As soon as C5 is sufficiently charged (a few  $\mu$ s) IC3a will be triggered. The Q output of this monostable performs the same function as the Q output of IC4a and that is to remove the reset from the 555 oscillator via N17. The Q output however removes the inhibit from the oscillator formed by N19 which means that IC1 is now clocked rapidly. Transistors T1...T4 are switched on in turn so that IC2 produces rather a horrendous noise. The clock rate, and therefore the noise, can be adjusted by means of the preset, P1. When the delay time of IC3a runs out, IC3b is triggered which in turn triggers off IC4b via N18 to reset the whole system once again. The circuit can of course be extended so that all sides have to be touched or indeed some of the sides touched more than once. However, we leave that to the discretion of the constructor — enough is enough!!

## The inside story for Owner/Trainers.

It will already be apparent that the secret of successful fireside training of the musical cube is knowing which sides are to be touched and in which order. Bearing in mind that, besides the four sides, the top is also a 'side', this making five sides in all (the side the cube resides on is, of course, the er... bottom).

It is up to the constructor/owner/trainer to decide the sequence of side touching but some discrete visual aids might prevent the O/T from getting side-tracked. Patterns etched in the copper sides will be the answer (and be an added aside to the conversation). As long as the side connections coincide with the circuit inside, the cube should stay on your side. Owners must be warned — we know of one cube that committed suicide by going up in a cube of flame, possibly due to ill treatment. ■

1

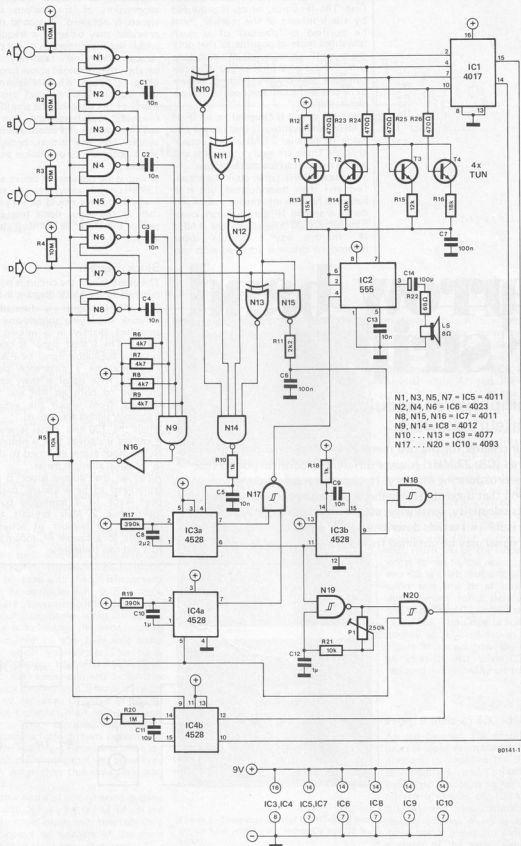

Figure 1. The complete circuit diagram of the musical cube. The really ambitious constructor might like to expand the circuit for more sides if he can find a cube to fit.

Several things have to be taken care of first. The IF signal, which is produced by the front-end of the receiver, must be 'purified' or 'cleansed' of as much unwanted noise as possible so that only the pure IF signal is left. This is done with the aid of a filter circuit. The circuit here uses crystals; which is known to be one of the best methods to achieve high selectivity.

The filter circuit is designed for an IF of 9 MHz. An advantage is that use may be made of popular 27 MHz '3rd octave' crystals. These are easily obtainable and what's more, at a reasonable price.

The pure 9 MHz signal could be amplified and then demodulated, but it is better to have an intermediary stage and derive a second IF with a much lower frequency (130 kHz) from the 9 MHz IF. In this way a 'double' super heterodyne circuit is achieved with two

important advantages. First, better suppression of the various spurious signals is obtained. A second mixer — provided they occur at a frequency at which the filter operates — will partially remove them. A relatively narrow bandwidth is obtained at low frequencies using LC filters. Another advantage of the 'double-super' is that the 'lion's share' of the signal can be amplified at a relatively low frequency. This makes amplifier design and construction much simpler and less critical, because it is less susceptible to oscillation and interference.

Would it be possible to derive an IF of 130 kHz right away? No, because the image frequency would be very close to that of the input signal required and would therefore be difficult to filter away.

# narrow band IF strip

## an IF amplifier/demodulator for amateur receivers

An amateur receiver for the two metre (144 MHz) band or for the citizens-band (CB; 27 MHz) is quite different in construction to that used by the broadcasting industry. It is not the quality of the reproduction that determines whether a particular receiver is good or bad, but its selectivity, sensitivity, etc. In other words, how universally applicable is it? This article describes part of a receiver and how a low frequency signal may be obtained from a narrow-band AM or FM IF signal.

### Block diagram

The operation of the circuit is put into a nutshell by the block diagram in fig. 1.

The 9 MHz signal is filtered in a network employing crystals and is then amplified slightly in a mixing circuit (MIX). The 9 MHz signal is combined with an oscillator signal of 8.87 MHz. This produces a difference signal of 130 kHz. The signal is then amplified and fed to both an AM and an FM detector from which the actual low frequency signals are derived.

When the 130 kHz signal is amplified, a voltage is derived that is proportional to the input signal and used to drive an 'S' or signal strength meter.

Although the 'double super' is usually considered to be a luxury, costs have been kept to a minimum by using inexpensive 27 MHz crystals and by reducing the number of active components to a couple of uncomplicated IC's and two transistors.

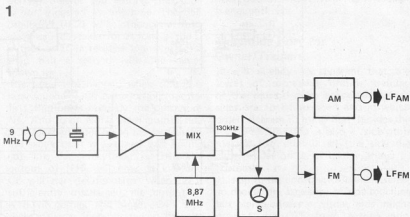

Figure 1. Block diagram of the Narrow Band IF receiver. It is a 'double-super heterodyne' design. The IF signal of 9 MHz is mixed with an oscillator signal of 8.87 MHz to create a difference signal of 130 kHz. It can accept AM and FM modulated inputs.



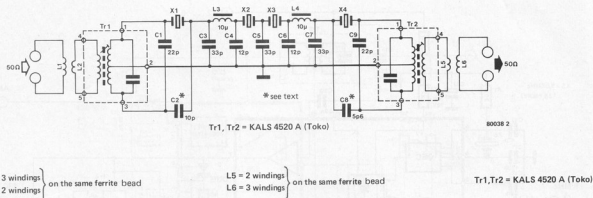

Figure 2. The crystal filter for the 9 MHz IF, uses 27 MHz '3rd harmonic' crystals.

### The 9 MHz Filter

Figure 2 shows the crystal filter for the IF signal from the front-end. It is a totally passive circuit, which only means that it has no amplification of its own. As has been shown before, it is better to filter an IF signal thoroughly first and then amplify it before using the 'old-fashioned' method of an amplification stage followed by a filtering stage followed by an amplification stage and so on. The main reason for this is that if an RF signal is amplified too early all the unwanted signals may overload the amplifier stage. It is advisable to filter them first, even though this may weaken the desirable part of the signal. After all, it can always be amplified later on.

The input and output of the crystal filter are both adapted to the standard high-frequency impedance of 50 ohms. This is achieved with the aid of two very simple home-made HF transformers. Details are given alongside the schematic. The input transformer is not critical. Its purpose is to change the impedance to that required by the following transformer which is selective. This transformer is really a 10.7 MHz FM IF filter, but it has been converted for the frequency desired here. This is done by means of capacitor C1. It is in parallel with the capacitor built into the transformer. This increases the total capacitance which in turn reduces the resonant frequency. Because of the need to adapt the transformer, no other type of Tr1, other than that indicated, may be used.

The lion's share of the filtering is done by crystals X1...X4, all of which are '3rd harmonic' types, meaning that they are supposed to resonate at the third harmonic of their rated frequency. This is 9 MHz. Between X1 and X2 and between X3 and X4 a network has been inserted to prevent undesirable impedance jumps. L3 and L4 are ordinary

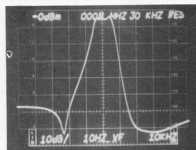
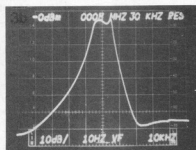
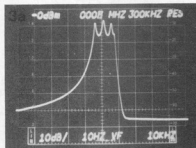

Figure 3. These curves show the effect of the crystal filter and the difference C2 and C8 make.

In figure 3a, these capacitors are omitted; figure 3b shows filter operation with C2 = 10 and C8 = 5p6; finally, for figure 3c the capacitors were trimmed to an optimal value.

miniature coils with a value of 10  $\mu$ H. Tr2 has been converted from a 10.7 MHz transformer like Tr1. Here C9 is in parallel with X1 and X4 respectively. Do capacitors C2 and C8, which are in parallel with X1 and X4 respectively, affect the incidence of the slope? They can be left out if necessary. Ideally speaking, they should be replaced by trimmer capacitors with a value between 2 and 22 p. Then the filtering may be trimmed until the slope is as steep as possible. Unfortunately, quite a lot of complicated and expensive equipment is required to optimally set such a trimmer. So the trimmer will not be optimally set, but it comes quite close. Figure 3 shows that this doesn't present any problems because the filter continues to work well, regardless of the slope. Even if the worst comes to the worst (figure 3a) C2 and C8 are left out altogether, attenuation will still be at least 50 dB. An improvement for a start would be to give capacitors C2 and C8 set values (see figure 3b). The slope (a function of frequency vs.  $U_0$ ) will then be about 3. Figure 3c shows how the crystal filter works at its best, when C2 and C8 are replaced by optimally set trimmers.

### From 9 MHz to 130 kHz

As can be seen, the circuit in figure 4 bears a close resemblance to the block diagram. It amplifies the 9 MHz signal, is amplified and mixed with the 8.87 MHz oscillator signal to produce a difference signal of 130 kHz. This is filtered and then amplified. In the mixing process a signal is derived to drive the S meter (to indicate relative strength of the aerial signal). Furthermore, the actual AM detection also occurs in this part of the circuit.

The circuit has been constructed around a single IC; the TCA 440. This chip

4

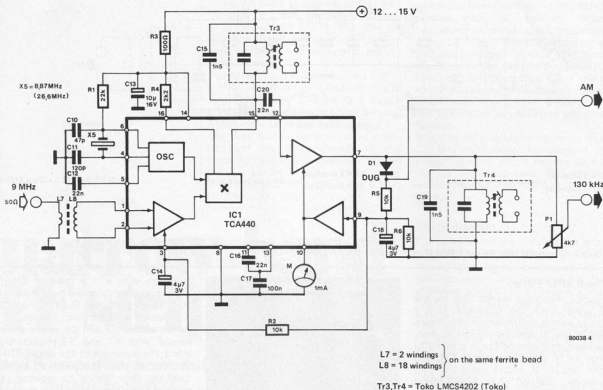

Figure 4. The TCA 440; designed for use in AM radios, it is used here to change the first IF (9 MHz) to the second IF (130 kHz).

made it possible to design an inexpensive, and simple, single IC mediumwave receiver.

By means of a home-made transformer, (coil data given with the schematic) the 9 MHz signal reaches pins 1 and 2 of the

IC. These are the inputs of an amplifier stage. The amount of amplification is determined by the voltage at pin 3. Later it will become apparent where that comes from. The amplified 9 MHz signal arrives at a multiplier used as a

mixer. The other input signal of the mixer originates from an oscillator which generates a signal of 8.87 MHz. This is done with the aid of crystal X5. This may be an 8.87 MHz crystal but a 3rd harmonic of 26.600 MHz may also be used, as was done for the crystals in figure 2.

The signal of one of the mixer's outputs is used to derive the second IF signal of 130 kHz. This is done with the aid of transformer Tr3. Like the other two transformers in figure 2, it will be a 'converted' transformer. This time it's a 455 kHz IF transformer of which the resonant frequency has been reduced to 130 kHz by adding C15.

The signal across the resonant circuit (the secondary coil is not used) is fed to a second amplifier section in the TCA 440. This really consists of three amplifiers in parallel, thereby considerably increasing the signal strength. The signal must not be limited, especially where AM detection is concerned, because the low frequency information is in the amplitude. For this reason an automatic amplifier gain control has been incorporated. This works as follows: the output signal of the second amplifier section is rectified by D1 and C18; this produces a direct voltage which has three purposes. They are:

5

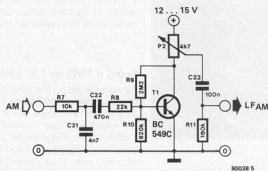

Figure 5. The one transistor amplifier/filter for the AM output.

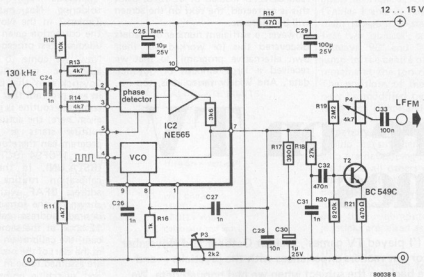

Figure 6. The FM detector. A phase locked loop (PLL) principle is employed here.

- To control amplification in the first 9 MHz amplifier stage.
- To control amplification in the second amplifier stage.
- To provide a signal for the S meter.

The 130 kHz signal must now be fed to the FM detector. Before this however, it will have to be filtered once more using the earlier mentioned 455 kHz transformer Tr4. Potentiometer P1 is required to adjust the amplitude of the signal to a level which the FM detector can handle.

Since the 130 kHz signal is being rectified, (for the automatic gain control) we already have a detected AM signal at our disposal. This can be derived from D1's cathode; as given in the schematic. Attention should be paid to the fact that D1 is a germanium diode, (for instance an AA 119 type) not a silicon diode.

The detected AM signal is amplified in the single transistor amplifier stage shown in figure 5. Any remaining 130 kHz signal is filtered out using the simple RC network R7/C21. Potentiometer P2 controls the level of the low frequency output signal.

#### FM demodulator

One of the best ways to demodulate an FM signal is to use a phase lock loop

(PLL). What it really comes to is having a voltage controlled oscillator (VCO) make an accurate copy of the IF signal. A phase detector then checks whether the VCO is doing it properly and sends a control voltage to the VCO as soon as any change is detected in its frequency. This is the demodulated FM signal.

The adapted IC in figure 6's FM detector also contains a PLL. By means of the IC's pin 2, the phase detector is fed with the 130 kHz signal. By way of the other input (Pin 5) another signal reaches a phase detector after originating from the VCO. The phase detector makes sure (by means of an amplifier) that both its input signals have the same phase and frequency, and its output is at the same time, the low frequency signal desired. C28, R17 and C30 form the loop filter. Its dimensions are determined by the characteristics of the PLL. Although the 9 MHz crystal filter has a bandwidth of approximately 10 kHz, a frequency deviation of 4.5 kHz can be processed. The PLL operates well at a deviation of up to 6 kHz, in other words, for all the signals which pass through the crystal filter.

The low frequency signal is amplified, like the detected AM signal, in a single transistor stage. With the aid of R18 and C31 any spurious, left over 130 kHz

signal is suppressed. The output level may be preset with P4.

The FM demodulator operates optimally at an input voltage of approximately 200 mV. That is why potentiometer P1 has been introduced into the circuit. It presets the optimal level of the signal for the demodulator.

When building the FM demodulator, a high quality capacitor must be chosen for C26. This is one of the components of the VCO which determines its frequency.

The only trimming point of the FM demodulator is the preset potentiometer P3. Trimming is best accomplished by setting P1 (figure 4) at a maximum, so that the input signal of the PLL is as large as possible. Now it should be possible to adjust P3 so that an FM signal is demodulated (which should, of course be available!). Usually, demodulation will be possible over a fairly large part of the range of P3. Set P3 somewhere in the middle of its range, and increase P1 slightly so that the signal level at the detector's output is reduced. P3's range (in which FM demodulation occurs) will now be smaller; then set P3 again somewhere in the middle of that range. This may be repeated until no noticeable change occurs when P3 is varied. At this point P3 is optimally tuned.

First, the joysticks. Readers' reactions and data were highly varied, to say the least. Unfortunately, there was one misprint in the 'test program' given (Table 17 in the November issue): at address 097A, the instruction should read 0E427B instead of 0E4278. Until this is corrected, the text on the screen will be nonsense.

However, a sufficient number of readers discovered this (or worked out their own alternative program), so that we received a large amount of 'joystick data'. And widely varied it is, too . . .

promises,  
promises . . .

# more on TV games

In earlier articles ('I played TV games', Elektor October and November 1979) we asked for our readers experiences with the joysticks — and promised to come back on the subject when we had enough data. We received several interesting reactions to this request, often including other suggestions and comments.

By now, we feel that it is high time to bring all other interested readers up to date!

The minimum values found vary between 05 and 28; the maxima were anywhere between 25 and FA. The mid-range could be anything between 15 and 7E. Help! What do you do when one person's minimum is more than someone else's maximum? The only result that was consistent (not surprisingly) was the value obtained without any joystick connected: 0D in all cases. Against all odds, we think we have a solution that should satisfy everyone. It is based on two conclusions from the results given above:

- If joysticks are to be used, (automatic) calibration is essential.
- Wherever possible, the joysticks are best used as four-way switches (signalling 'up', 'down', 'left' or 'right'). Trying to obtain data that corresponds to all possible positions is virtually doomed to failure, insofar as it is to be compatible with other computers. For strictly 'personal' programs it is no problem, of course.

Before describing our solution, there is one other point that must be made clear. As several readers have pointed out, our 'definition' of the joystick connections is not ideal. Furthermore, it does not correspond to that used in the program given as File 1 on the ESS003 record, nor to that used in a commercial TV games computer based on the same CPU and PVI. For these reasons, we have decided to specify the following 'standards' (see figure 1):

- Left joystick = address 1FCC;
- right = 1FCD.

- Horizontal movement = flag off; vertical = flag on.
- Low data value = left or up; high value = right or down.

Obviously, modifying an existing TV games computer to conform with these 'standards' will require some re-soldering. Not much, however, and Table 17 in the November issue (with the correction given above) provides an adequate test procedure.

Now, we come to our 'solution'. An automatic calibration routine and 'joystick scan' that can be incorporated in any program that uses joysticks. The complete routine is given in Table 1. As given here, the actual initial calibration routine starts at address 0F94. A program can therefore be started in two ways: 1F0F94 (BCTA,UN) or 3F0F94 (BSTA,UN). In the latter case, the calibration routine is concluded at address 0FAF with 16, C0, C0, as shown; in the former, a branch to any desired address can be inserted as 1Exxxx, at the same address. In either case, the calibration routine is run once, at the start of the program. The joysticks are assumed to be in their mid positions, and switching points relative to these positions are calculated and stored from address 0FC0 on.

In passing, it may be noted that the 'wait for VRLE' subroutine (starting at address 0F80) may well prove useful at various points in the main program.

Having calibrated the joysticks, control returns to the main program. At any point in this program, a joystick scan can be requested by branching to the subroutine that starts at address 0FC8. For correct operation, this 'branch to subroutine' must occur at frame end — after a 'wait for VRLE' loop, for instance. Depending on the program, several variations on the routine given may prove useful:

- at address 0FC8, the upper register bank can be selected (to protect existing data in R1 . . . R3) by modifying the instruction to 7712.
- from address 0FF8 on, additions can be incorporated: either resetting the register bank (7510 = CPSL, RS) or storing the data found: R2 contains the left-hand joystick data, R3 that of the right-hand joystick.
- the instruction at address 0FD5 depends on the point at which the flag is set or reset. Obviously, to scan both horizontal and vertical joystick positions the flag must be set and reset on alternate frames. The routine given assumes that the flag is modified *after* the joystick scan routine has been run. In some cases, however, it may be preferable to modify the flag first; the instruction at address 0FD5 must then become 1802.
- The complete routine can be situated at any other point in memory, if required. Since most of the instructions use relative addressing, they can remain unchanged. The only exceptions are the absolute-indexed instructions at ad-

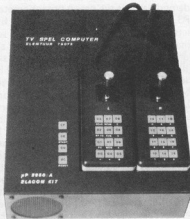

Table 1

0F80	0881	LODR,R0,Ind	} SUBROUTINE: WAIT FOR VRLE
0F82	0C1FCB	LODA,R0	
0F85	F440	TMI,R0	
0F87	9879	BCFR	
0F89	17	RETC,UN	
0F8A	C1	STRZ,R1	} SUBROUTINE: CALCULATE LIMITS
0F8B	51	RRR,R1	
0F8C	51	RRR,R1	
0F8D	453F	ANDI,R1	
0F8F	A1	SUBZ,R1	
0F90	C2	STRZ,R2	
0F91	81	ADDZ,R1	
0F92	81	ADDZ,R1	
0F93	17	RETC,UN	
CALIBRATION ROUTINE			
0F94	7660	PPSU,I1/Flag	(flag on = vertical)
0F96	7518	CPSL,RS/WC	
0F98	3B66	BSTR,UN	} clear VRLE, wait one scan
0F9A	3B66	BSTR,UN	
0F9C	0880	LODR,R0,Ind	} 1FCC = left 1FCD = right
0F9E	08B1	LODR,R3,Ind	
0FA0	3B68	BSTR,UN	} calculate and store lower and upper limits left
0FA2	C81D	STRR,R0	
0FA4	CA1A	STRR,R2	} calculate and store lower and upper limits right
0FA6	03	LODZ,R3	
0FA7	3B61	BSTR,UN	} return if all limits set. Note: absolute branch with 1Exxxx (flag off = horizontal)
0FA9	C818	STRR,R0	
0FAB	CA15	STRR,R2	} shift data
0FAD	B440	TPSU,flag	
0FAF	16	RETC	
0FB0	C0,C0	2xNOP	
0FB2	7440	CPSU,flag	
0FB4	0504	LODI,R1	
0FB6	0D4FC0	LODA,I-R1	
0FB9	CD6FC4	STRA,I/R1	
0FBC	5978	BRNR,R1	
0FBE	1B58	BCTR,UN	
0FC0	00 00	00 00	} limit data
0FC4	00 00	00 00	
	left	right	
SUBROUTINE: JOYSTICK SCAN			
0FC8	7702	PPSL,COM	(or 7712 = PPSL,RS/COM)
0FCA	20	EORZ,R0	} clear R1, R2 and load joystick data
0FCB	C1	STRZ,R1	
0FCC	C2	STRZ,R2	} preset for R1, if vertical. Note: sometimes 1802 = BCTR is required
0FCD	0C1FCC	LODA,R0	
0FDD	0F1FCD	LODA,R3	
0FDD	B440	TPSU,flag	
0FDE	9802	BCFR	} result left joystick in R2
0FDF	0504	LODI,R1	
0FD9	ED2FBF	COMA,I+R1	} result right joystick in R3
0FDC	9A02	BCFR	
0FDE	A601	SUBI,R2	
0FE0	ED2FBF	COMA,I+R1	
0FE3	9902	BCFR	
0FE5	8601	ADDI,R2	
0FE7	03	LODZ,R3	
0FE8	0700	LODI,R3	
0FEA	ED2FBF	COMA,I+R1	
0FED	9A02	BCFR	
0FEF	A701	SUBI,R3	
0FF1	ED2FBF	COMA,I+R1	
0FF4	9902	BCFR	
0FF6	8701	ADDI,R3	
0FF8	17	RETC,UN	
0FF9	C0		} room for 7510 = CPSL,RS, and/or CExxxx, CFxxxx for data transfer
0FFF	C0		

Table 1. Joystick calibrate and scan routines.

addresses 0FB6, 0FB9, 0FD9, 0FE0, 0FEA and 0FF1. These all depend on the position of the data, stored here from address 0FC0 on.

To illustrate how this routine works, a very simple demonstration program is given in Table 2. Once both programs (Tables 1 and 2) have been loaded, the main program is started at 0900. The first two 'objects', corresponding to the displays 'PC' and '=' respectively, will jump to the centre of the screen ('0900' remains at the top right of the screen).

The positions of these two objects can now be modified by means of the left-hand and right-hand joysticks, respectively.

Hopefully, the suggestions given here should be sufficient for those readers who are developing their own programs. As far as all others are concerned, the only thing that is important is that all programs that will be supplied as 'Elektor Software' in future should run on their computer - provided the joysticks are wired as outlined above.

### Interrupt!

It is now time to acknowledge an interrupt request... A very welcome one, at that. As mentioned earlier, we received several reactions from readers. One of the subjects that was often mentioned was the 'interrupt' facility. One reader in particular, Mr. Norman, sent us a long letter in which he offers the following tips:

'When using interrupts, you demonstrate the method of looping the main program and leaving everything to the interrupt routine(s). This is a little 'wasteful' in processing time and I find it preferable to 'share the workload' - object movement and collision detection, say, to the interrupt routines and score updates, off-screen travel, key scan etc. to the main program.

'To run both main and interrupts, it is essential that registers and condition codes do not 'clash' and you do not describe techniques in any great detail.

'If the interrupt routine uses, say, the upper register bank whilst the main program uses the lower register bank, then a typical interrupt routine may commence as follows:

```

7710 PPSL,RS
CC08FE STRA,R0
13 SPSL
CC08FF STRA,R0
and end:
0C08FF LODA,R0
93 LPSL
0C08FE LODA,R0
7510 CPSL,RS
37 RETE,UN

```

'It is vital that PSL is preserved, otherwise the main program may make decisions on a condition code set by the interrupt program!'

Very true. However, as another reader has pointed out, the above routine is not quite correct: *after* restoring the PSL data, R0 is re-loaded - altering the Condition Code!

Table 2

Joystick demo routine:			
0900	3F0F94	BSTA,UN	calibrate routine
0903	7440	CPSU,flag	horizontal
0905	3F0F82	BSTA,UN	wait for VRLE
0908	3F0FC8	BSTA,UN	read joysticks
090B	0828	LODR,R0	}
090D	82	ADDZ,R2	
090E	C825	STRR,R0	Hor. pos. obj. 1
0910	CC1F0A	STRA,R0	}
0913	0821	LODR,R0	
0915	83	ADDZ,R3	Hor. pos. obj. 2
0916	C81E	STRR,R0	}
0918	CC1F1A	STRA,R0	
091B	7640	PPSU,flag	vertical
091D	3F0F82	BSTA,UN	wait for VRLE
0920	3F0FCA	BSTA,UN	read joysticks
0923	0812	LODR,R0	}
0925	82	ADDZ,R2	
0926	C80F	STRR,R0	vert. pos. obj. 1
0928	CC1F0C	STRA,R0	}
092B	080B	LODR,R0	
092D	83	ADDZ,R3	vert. pos. obj. 2
092E	C808	STRR,R0	}
0930	CC1F1C	STRA,R0	
0933	1B4E	BCTR,UN	}
0935	44 55 77 71		

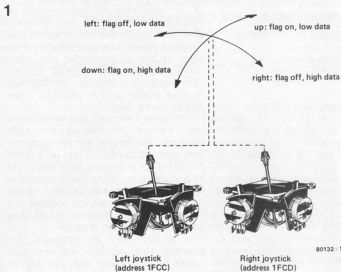

Figure 1. This drawing illustrates the new 'joystick standards' explained in the text.

A routine that seems to meet all requirements is the following:

Start the interrupt routine with:

```
7710 PPSL,RS
CC09F1 STRA,R0
13 SPSS
CC09F3 STRA,R0
24 EF EORI,R0
CC09F5 STRA,R0
```

and end, at 09F0 say, with:

```
09F0 04XX LODI,R0
09F2 77XX PPSL
09F4 75XX CPSL (including RS!)
09F6 37 RETE,UN
```

Obviously, the three absolute addresses in the 'save' routine will depend on the position of the 'restore' scratch bytes.

### More on the PVI.

Another topic that has elicited several comments is the PVI. Two points, in

particular, have been raised quite frequently.

- As can be derived from the documentation supplied with the p.c. board, several addresses in the PVI are available as 'scratch'. So far, we have never actually used them ourselves, but several readers have pointed out that they can indeed be used in the same way as the 'normal' RAM.

- Also shown in the documentation is the fact that the 'I/O and control' field is actually repeated four times: 1FC0...1FCD, 1FD0...1FDD, 1FE0...1FED and 1FF0...1FFD. This proves of particular interest for the data stored at addresses 1FCA and 1FCB (collisions, VRLE, etc.). Both of these bytes are cleared when read, which can be a nuisance. However, one reader has pointed out that reading

1FCA, say, only clears this one byte — it does not clear 1FDA, 1FEA or 1FFA! This means that a different address can be used for retrieving data for each object, as required, without affecting the information required later on for one of the other objects. Useful!

### Questions and errors.

We are often asked why some programs store 04 at address 1E80. This was news to us, but since then we have found the reason. Apparently, a commercial version of the TV games computer exists, with the same CPU and PVI. However, there is a difference: when 04 is stored in 1E80, the sound effects are reproduced through the TV receiver! We don't know how this works — it certainly doesn't apply to our version — but maybe someone can enlighten us?

Another regular query concerns R58. In the circuit, this resistor is shown connected to the video output — and rightly so. However, observant readers have found that it is connected to positive supply on the p.c. board. When this mistake was discovered, we immediately tested several of our prototypes to see what the effect was. To our surprise and relief, it doesn't make a scrap of difference! Which is why we didn't mention it earlier.

A few readers have run into a minor 'problem' concerning the 'vertical offset' for the duplicates. It was perhaps not made sufficiently clear that a vertical offset 'FF' is used as 'minus one': the gap between duplicates becomes zero. To delete the duplicates entirely, an offset 'FE' must be stored.

Finally, it was stated in the original article that only file numbers up to 9 are permissible. This is an unnecessary limitation: any single-digit number (1...9) can be used.

Interrupt! Mr. Norman again: 'In Elektor 48, page 28, figure 2a you show IC6 connections incorrectly. The A7 lead should be connected to pin 13 and A6 should connect to pin 14. Furthermore, the labels for pins 13 and 15 are reversed: pin 15 is the '2c' input and vice versa'.

### A useful tip

Have you ever tried to develop a program? And discovered, after the first trial run, that you had omitted a few essential steps somewhere? Welcome to the club!

Inserting the necessary steps can be accomplished by replacing three of the original instruction bytes by an unconditional branch to an empty memory space, restoring the deleted instruction(s) there and adding the missing steps at that point before branching back. This system works, but it is anything but elegant. Those readers who have 'decoded' the space shoot-out program on the second ESS record for

the TV games computer will know what the end result looks like: a mess.

The only alternative is to move up the remainder of the program to make room. Unfortunately, this may well involve moving up several handwritten pages of perfectly good program, by laboriously keying them in again at the new addresses. This is a nuisance, to say the least. A so-called 'block transfer' routine is much easier — in effect, you make the computer do the bulk of the work.

The basic principle is quite simple. Let's assume that one additional 'store absolute' instruction (3 bytes) is to be inserted at address 0A00. The remainder of the program, say from 0A00 to 0AFE, will have to be moved up three places in memory. This can be accomplished as follows:

```

08C0      05F7      LODI,R1
08C2      0D4A00   LODA,I-R1
08C5      CD6A03   STRA,I/R1
08C8      5978      BRNR,R1
08CA      1F0000   BCTA,UN
  
```

When this program is started, at address 08C0, all instruction bytes are moved up three address positions — one at a time, starting at the 'top'. In practice the computer does the job so fast that the display on the screen hardly flickers. The only modifications that must then be entered by hand are all positions containing absolute address instructions that have been moved, and any relative addresses that operate 'across the gap'.

### What of the future?

More programs, in particular. We already have an updated version of the 'space shoot-out' that includes joystick calibration and a few more 'gimmicks', a 'Mastermind' program and an 'Amazone' game (man v. machine!). We're working on a random number generator for Bingo and a helicopter maze. In the near future, we hope to introduce a new ESS record — or maybe tape? — with these programs. We've also got stacks of other basic ideas, but developing programs takes time. Come on, readers, surely you've got some more ideas? I'm sure you're quite prepared to help you out if you've run into problems. The more programs, the merrier!

On the hardware side, we have some ideas. Memory extension? So far, we haven't needed it — but we have an extension circuit ready and tested. If enough readers want it, we can design a p.c. board. A random numbers generator? No problem — a few ICs will do the job. Basically, as far as we're concerned, you name it and we can provide it. However, we don't intend to 'waste' valuable magazine pages on circuits that only appeal to one or two readers. For this reason, we would very much appreciate reactions from interested readers: if several readers ask for an extension, that gives us a good reason to take it into consideration. Over to you!

## A little program

Mr. M. Saliger sent us a small program for automatically scanning existing software. After some drastic shortening, the result is as shown here. The first address of the program (section) to be displayed is stored at address 08C0, after which this routine is started at address 08C2. The addresses and instructions will now roll up the screen automatically; the display can be 'frozen' and re-started by holding the 'start' button down for a moment. If this key is held down continuously,

the 'scroll up' occurs at half speed. The speed is further determined by the data at address 1F9C.

When plotting long tables, it can be useful to modify the instruction at 08F0 to 0604, 0608 or 060C. Note that the first few instructions after a series of data values may be misinterpreted.

Return to monitor via the 'reset' key; don't operate the 'start' key in this mode, or the program from 1F80 on will be erased!

08C0	05F7	LODI,R1			
08C2	0D4A00	LODA,I-R1			
08C5	CD6A03	STRA,I/R1			
08C8	5978	BRNR,R1			
08CA	1F0000	BCTA,UN			
08C0	0000	2 scratch bytes for address			
08C2	7620	PPSU,I1			
08C4	0502	LODI,R1			
08C6	0D48C0	LODA,I-R1			} transfer start address
08C9	CD68A4	STRA,I/R1			
08CC	5978	BRNR,R1			
08CE	3F02CF	BSTA,UN			} scroll
08D1	3F042B	BSTA,UN			
08D4	0706	LODI,R3			} address to MLINE and scroll
08D6	CF488A	STRA,I-R3			
08D9	5B78	BRNR,R3			
08DB	3BF2	BSTR,UN,Ind.(02CF)			
08DD	0E88A4	LODA,Ind,R2			
08E0	F608	TMI,R2			} 1-, 2- or 3-byte instruction? Result in R2 as 01, 02 or 03
08E2	180C	BCTR			
08E4	F6A0	TMI,R2			
08E6	1806	BCTR			
08E8	2640	EORI,R2			
08EA	F654	TMI,R2			
08EC	1802	BCTR			
08EE	0604	ADDI,R2			
08F0	460C	ANDI,R2			
08F2	52	RRR,R2			
08F3	52	RRR,R2			
08F4	1F1F80	BSTA,UN			
(08F7)					
1F80	8704	ADDI,R3			} 1, 2 or 3 databytes to display; increment address
1F82	0D88A4	LODA,R1,Ind			
1F85	3F0354	BSTA,UN			
1F88	3F039F	BSTA,UN			
1F8B	FA73	BDRR,R2			
1F8D	3F020E	BSTA,UN			
1F90	0C1FCB	LODA,R0			} wait for VRLE; display 6 lines
1F93	D0	RRL,R0			
1F94	9A7A	BCFR			
1F96	7702	PPSL,COM			
1F98	3F0055	BSTA,UN			} SPEED
1F9B	8704	ADDI,R3			
1F9D	5B71	BRNR,R3			
1F9F	12	SPSU			
1FA0	0D1E8B	LODA,R1			} start/stop and 1/2 speed with 'start'
1FA3	4540	ANDI,R1			
1FA5	21	EORZ,R1			
1FA6	92	LPSU			
1FA7	8440	TPSU,flag			
1FA9	1865	BCTR			
1FAB	1F08CE	BSTA,UN			repeat

Readers who wish to use this program to scan the monitor software should note that the latter contains data at the following addresses:

```

0006 ... 0009
00AD ... 00BC
0122 ... 013D
0177 ... 0180
027B ... 02CE
02F5 ... 031C
0537 ... 053F
  
```

The RAM scratch starts at 0800. The start addresses for the main routines are:

- Initiate : 0023
- 'Reg' : 03B0
- 'Mem' : 040C
- 'BK' : 04A9 and 0594/05B2
- 'PC' : 050E
- 'Wcas' : 05E8
- 'Rcas' : 0758

For those readers who are not familiar with digital technology and thinking, a variable logic gate provides an excellent opportunity to 'get into' it. To make things easier, a truth table of all the logic functions is given in table 1. All the symbols representing the various logic functions are also included.

The noughts and ones indicate the logic level. A '0' means 0 volts and a '1' means there is a voltage (for TTL it is +5 V). The truth tables indicate how the output (Q) behaves when various logic states are fed to the input (A) or inputs (A and B).

# variable logic gate

M. van Kerkwijk

The variable logic gate, which was published in the June 1979 issue, generated more interest with readers than expected. Unfortunately, the IC required appeared to be difficult to obtain. This gave many of our imaginative readers food for thought. One of the designs consists of two inexpensive and readily available IC's and is presented here.

The simplest logic gate is the buffer. The logic state applied to the gate's input also appears at its output. This can also be shown in (Boolean) algebraic form (see the second column in table 2):  $Q=A$ . The buffer's purpose is, as its name suggests, to increase the current driving ability of a given logic line.

The inverter does more than the buffer. As well as buffering the input to the output, it also inverts the logic state of the input. A '1' at the input will produce a '0' at the output and vice-versa. The algebraic formula for this function is:  $Q = \bar{A}$ , where the line over the 'A' indicates its inversion.

The AND gate is a gate with at least two inputs. Output (Q) is a logic '1' only if both the inputs are also at a logic '1'. The algebraic equation for this function is:  $Q = A \cdot B$  where the point must be read as 'and'.

The NAND works almost exactly the same except that there is an inverter on

the output. The truth tables show this clearly. The equation for this function is:  $Q = \overline{A \cdot B}$ .

The OR gate does something quite different. It produces a logic '1' on the output if input A or input B has a '1' fed to it. It also has a '1' on the output if both the inputs are '1'. Expressed in algebraic terms, this is:  $Q = A + B$  where '+' is to be read as 'or'.

The OR gate also has an inverted type, the NOR gate. The truth tables clearly show the inverting of the OR states. The formula here is:  $Q = \overline{A + B}$ . Two gates are left: the EXOR and the EXNOR gates. The EXOR (exclusive OR) behaves in the same way as the OR gate with the exception that if both inputs are logic '1', the output is not logic '1' but '0'. To express this difference in algebraic terms the sign  $\oplus$  is used. It then reads:  $Q = A \oplus B$ .

The EXNOR gate is, as you might expect, the inverse of the EXOR. This can be seen from the truth tables. The formula then reads:  $Q = \overline{A \oplus B}$ . It all sounds very impressive, but what is the point of these logic gates? you may well ask. Let us take a practical example in which a logic function is used. To cut a piece of metal an automatic cutting machine is used. It can of course be a rather sticky business if, while operating the machine with one hand, you happen to forget to remove the other from under the blade. To prevent this sort of thing from happening, operation may be made to be two-handed, in other words, two pushbuttons need to be depressed before cutting begins. Here an AND circuit with two inputs may be used. The inputs receive their information from the pushbuttons and the output operates the machine by means of a relay. Only when both buttons are depressed is there a '1' at each input, thus a '1' at the output. A relay clicks and the machine cuts the metal plate. A safety measure may be included for the sake of those dare devils who try to push the metal plate forward with their feet, thereby accidentally starting the machine. Then an AND gate with four inputs and four operation buttons needs to be used, so that the person in question has his hands and feet tied during

1

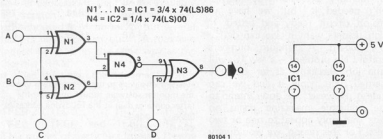

Figure 1. The variable logic gate consists of four TTL gates. By programming certain inputs this gate may carry out all the outlined logic functions.



Table 1

buffer

Input	output
A	Q
0	0
1	1

inverter

Input	output
A	Q
0	1
1	0

AND

Input	output	
A	B	Q
0	0	0
0	1	0
1	0	0
1	1	1

NAND

Input	output	
A	B	Q
0	0	1
0	1	1
1	0	1
1	1	0

OR

Input	output	
A	B	Q
0	0	0
0	1	1
1	0	1
1	1	1

NOR

Input	output	
A	B	Q
0	0	1
0	1	0
1	0	0
1	1	0

EXOR

Input	output	
A	B	Q
0	0	0
0	1	1
1	0	1
1	1	0

EXNOR

Input	output	
A	B	Q
0	0	1
0	1	0
1	0	0
1	1	1

operation. Admittedly, in practice no use will be made of a real AND gate in such a case, but the four pushbuttons would be placed in series to the engine. Even then it is still an AND function. This is a simple yet useful way in which digital technology may be applied. And there are many other examples like it.

### The variable logic gate

In figure 1 the layout of the gate is given. This circuit is capable of fulfil-

2

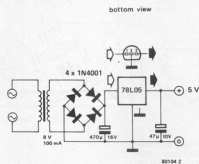

Figure 2. Power supply for the variable logic gate.

ling all the digital tasks hitherto mentioned. As illustrated, the variable gate consists of three EXOR gates and a NAND gate. How the circuit may be programmed to carry out a particular function, is shown in table 2. Supposing we wish to turn the variable gate into an OR function. Input C will then be connected to the + of the supply (logic '1') and input D to ground (logic '0'). This creates an OR gate with inputs A and B and an output Q. An EXOR function is obtained according to table 2 by connecting input D to the supply voltage (logic '1'). Inputs A and B are connected to each other, so

that they form a single input. Input C serves as a second input. If one wishes to consult the truth table for the EXOR gate (table 1) while experimenting, then inputs A and B will need to be read as A/B and C respectively.

### Construction

The logic variable gate is best built with TTL or with low power schottky TTL IC's. The circuit needs to be fed with a voltage of 5 V. A 4.5 V battery is therefore not suitable here. The power sup-

3

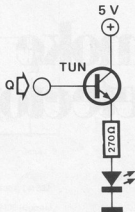

80104 3

Figure 3. With the aid of this logic probe the logic state at the output of the variable logic gate may be read directly.

Table 2

name of gate	algebraic function	programming		input (s)	output
		B	C D		
buffer	$Q = A$	0	1 0	A	Q
Inverter	$Q = \bar{A}$	1	0 0	A	Q
AND	$Q = A \cdot B$	0	1	A and B	Q
NAND	$Q = \overline{A \cdot B}$	0	0	A and B	Q
OR	$Q = A + B$	1	0	A and B	Q
NOR	$Q = \overline{A + B}$	1	1	A and B	Q
EXOR	$Q = A \oplus B$	1	1	A/B and C	Q
EXNOR	$Q = \overline{A \oplus B}$	0	0	A/B and C	Q

Under the heading Aplikator, recently introduced components and novel applications are described. The data and circuits given are based on information received from the manufacturer and/or distributors concerned. Normally, they will not have been checked, built or tested by Elektor.

## 1

## smoke detector

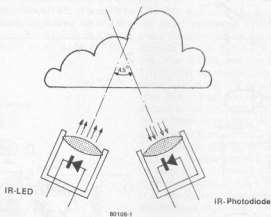

Figure 1. When smoke is present, infrared light is reflected off it and detected by the photodiode.

The MEM 4963, recently introduced by General Instrument Microelectronics, is an IC specifically designed for use in smoke detector circuits. It is an improved version of the older MEM 4962.

Many professional smoke detection installations use an ionisation chamber and, since this device is radio active, an exclusive permit must first be obtained. In this article we will discuss, what is for us, a more familiar method — infrared light.

The drawing in figure 1 illustrates how the presence of smoke can be detected by means of infrared light. An infrared LED and photo diode have been placed at an angle of  $45^\circ$  to each other. Smoke has to be present before the photo diode will detect infrared light. It is really that simple.

However, an LED and a photo diode alone do not make for a reliable fire alarm. In figure 2 the complete circuit for a suitable alarm using the MEM 4963 is shown. The circuit can be used as it stands, or, together with any number of identical circuits, can create a larger fire alarm system. The circuits are then connected by only two wires (pin 8 of IC2 and supply common) as indicated in the diagram and will detect smoke both individually and collectively. Furthermore, each smoke detector will test its own battery state at regular intervals.

### Four states

The circuit in figure 2 makes a distinc-

tion between four states and will react differently in every case.

1. The circuit detects smoke itself and sounds an alarm continuously. It also sends a signal to the other circuits connected to it.
  2. If one of the other circuits detects smoke, the alarm will not sound continuously but in pulses during 30 ms for every 100 ms.
  3. The circuit 'notices' that its battery is running out. The alarm then sounds 3 ms for every 40 seconds.
  4. Standby state.
- Conditions 1...4 have a decreasing priority. That is to say that when, for instance, the circuit detects smoke around it and at the same time its battery appears to be running out, it is considered more important to report the smoke than the low battery state. There is something to be said for this, of course.

The infrared LED is not continuously supplied with current, but is pulsed. The repetition time of the 150  $\mu$ s long current pulses is about 10 seconds for conditions 3 and 4, when there is no sign of smoke. If smoke has been detected, however, either by the circuit itself or by one of its kind, pulse repetition rate goes up to 0.4 seconds. It is better not to regulate the LED continuously to save battery power. At rest, the current consumed by the circuit will be no more than approximately 10  $\mu$ A.

The LED is not only controlled to test for smoke, but also to check the battery's state. After all, the voltage

during a loaded condition is important. As soon as this drops below the value of the zener diode plus approximately 0.2 V the battery alarm (state 3) is sounded. The battery voltage is measured by means of pin 13 of the IC; pin 14 is the connection for the supply voltage.

The infrared LED D1 draws a lot of current. This is necessary in order to give the detector diode D2 a clear signal which deviates from the infrared environmental light which is almost always present everywhere. The applications schematic uses fairly unknown types for D1 as well as D2, but no doubt the circuit works just as well with the more common numbers given in brackets. P1 can be preset to reference the input of the opamp within its modulation range. Potentiometer P2 serves to regulate the circuit in such a way that the alarm will only sound when smoke is present. First place P2 in the centre of its travel and then preset P1.

The MEM 4963 has another CMOS compatible output at pin 4. Normally this will be a logic 0 but when the alarm goes off, it changes to a logic 1. The current capability of the pin 5 output is approximately 240 mA. ■

# applikator

Under the heading Applikator, recently introduced components and novel applications are described. The data and circuits given are based on information received from the manufacturer and/or distributors concerned. Normally, they will not have been checked, built or tested by Elektor.

2

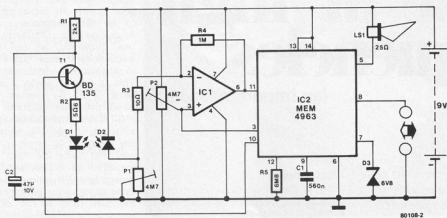

- IC1 = LF 356, LF 357, LM 301, LM 307
- IC2 = MEM4963
- D1 = HEMT-3300 (HP), OP195 (Optron), (LD241, LD242, LD271)
- D2 = VTS 40855, CLD 31, (BPW 34, SFH205)

Figure 2. Smoke detector circuit using infrared light and the MEM 4963.

## MEM4963 BLOCK DIAGRAM

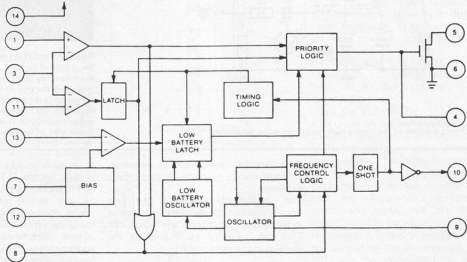

80108 3

# noise at high frequencies

(an important factor)

Noise in UHF/VHF receivers can be determined by using extensive and expensive test equipment. However, tests with a noise generator can give usable results at a much lower cost. Such a noise generator can, of course, be constructed by the amateur.

## What is noise?

Noise is caused by highly complicated physical and thermodynamic processes. Briefly, it is the random movement of electrical charge carriers. Noise increases with rise in temperature: at absolute zero ( $-273^{\circ}\text{C} = 0\text{ K}$ ) noise is zero, for at this temperature all movement is frozen. This is why during certain critical processes, cryogenic techniques are used to attenuate the noise factor

to obtain a certain signal-to-noise ratio at the output.

## How to determine the noise factor

The noise factor in receivers can be calculated in two different ways, either from a sensitivity or from a noise measurement. In order to test sensitivity a signal generator is required; however, good quality HF signal generators tend to be very expensive... Instead of measuring the sensitivity with only one frequency, we can apply many frequencies at once: use a noise signal, in other words.

This is how it works. First the basic noise  $N$  of the receiver is measured when the noise generator is switched off. Then the noise generator is switched on and the noise level is set (by means of an attenuator) in such a way that twice the input level can be measured at the output. This corresponds to a S/N ratio of 3 dB. The nice thing about using noise methods is that the S/N ratio is not dependent on temperature or bandwidth.

## Circuit

A small generator can be built with inexpensive and readily available components as shown in figure 1. A high frequency transistor (T2) is connected

1

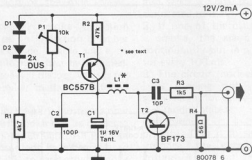

Figure 1. Circuit diagram of the simple high frequency noise generator.

with very low temperatures. However, it is not always practical to go to these extremes.

The signal-to-noise ratio is the best known method for determining to what extent noise ( $N$ ) affects the signal ( $S$ ). This can be done by expressing the signal-to-noise ratio in dB:

$$S/N = 10 \log S/N \text{ dB}$$

Taking a certain point in the receiver (after the demodulator for instance), it can be determined how many microvolts are required at the input in order

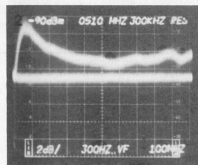
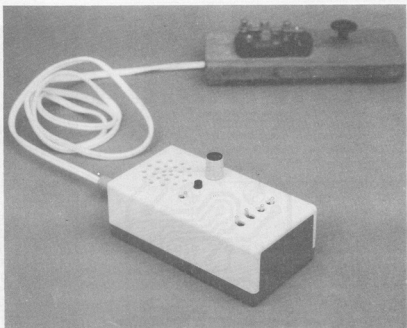

Figure 2. Part of the frequency spectrum of the circuit of figure 1. On the upper trace the frequency is shown horizontally (100 MHz per cm) and the amplitude vertically (2 dB per cm). The lower trace represents the noise produced by the spectrum analyser ( $-97\text{ dBm}$ ;  $0\text{ dBm}$  is  $1\text{ mW}$  with an impedance of  $50\ \Omega$ ).

as a zener diode. It is fed by a DC voltage source (T1). The noise voltage and therefore output level is determined by the setting of potentiometer P1 which controls the amount of current that flows through the zener diode. The output impedance of the circuit is approximately  $50\ \Omega$ . The photograph in figure 2 shows part of the generator's noise spectrum.

Obviously, the circuit cannot be expected to perform miracles. The stability (temperature coefficient of the voltage source T1) achieved in the long run is not ideal, but for comparative (short term) noise tests it is quite adequate. ■

For those who don't know, Morse is a little like binary without the logic. Understandably, learning the Morse code is a long process. In practical use one has to know all the signals by heart, there is no time to even think about it when listening to an actual transmission. Learning them is therefore very much like reciting multiplication tables in school. This is the idea behind the morse trainer.



# morse trainer

1

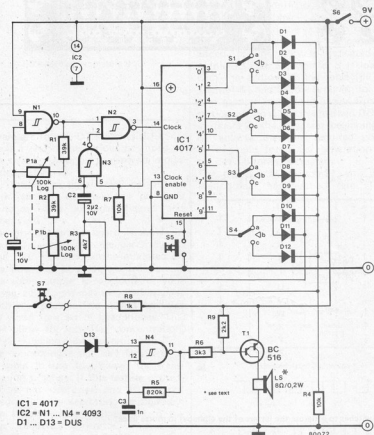

Figure 1. Schematic diagram of the morse trainer.

The morse trainer constantly repeats a certain signal which has been chosen by a few switches. A letter is represented in morse code by a series of dots and dashes, a dash lasting three times as long as a dot. The interval between two dots (and the dashes too) is determined by the clock generator (N1) in figure 1. The clock frequency can be varied for different difficulty factors (DF's?).

When S5 is depressed, the outputs '0', '1', '2', '3', etc. of IC1 (a decade counter) are high in series according to the clock frequency. (The counter switches on the positive slope of the clock squarewave.)

By using the outputs at '1' (pin 2), '3' (pin 7), '5' (pin 1) and '7' (pin 6) only, an equally long logic 0 follows every logic 1 of IC1.

If all the switches S1 ... S4 are on 'c', four short signals are given which enable the low frequency oscillator/amplifier to produce four 'dots' through the loudspeaker. This is the morse code for the letter 'H'. As long as switch S5 is depressed, the decade counter (through the low frequency oscillator) will repeat this signal over and over with short pauses in between.

If a switch is in the 'a' position however, the output of the corresponding pin of IC1 will be connected to an extra diode and an electrolytic capacitor C2. This prevents the clock signal from reaching the counter clock input (pin 14). The capacitor is discharged by R2 and P1b. The setting of P1b determines the time it takes to discharge C2. A dash is the result.

2

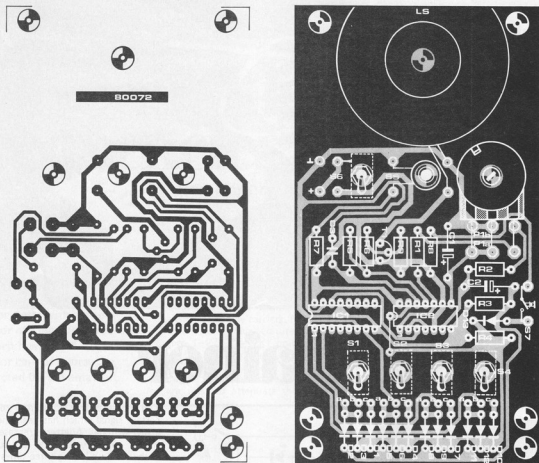

Figure 2. Printed circuit layout of the morse trainer.

Table 1.

	S1	S2	S3	S4		S1	S2	S3	S4
A	↓	↑	—	—	N	↑	↓	—	—
B	↑	↓	↓	↓	O	↑	↑	↑	—
C	↑	↓	↑	↓	P	↓	↑	↓	↓
D	↑	↓	—	—	Q	↑	↑	↓	↑
E	↓	—	—	—	R	↓	↑	↓	—
F	↓	↑	↑	↓	S	↓	↓	—	—
G	↑	↑	↓	—	T	↑	—	—	—
H	↓	↓	↓	↓	U	↓	↓	↑	—
I	↓	↓	—	—	V	↓	↓	↑	↑
J	↓	↑	↑	↑	W	↑	↑	↓	—
K	↑	↓	↑	—	X	↑	↓	↓	↑
L	↓	↑	↓	↓	Y	↑	↑	↑	↑
M	↑	↑	—	—	Z	↑	↑	↓	↓

Table 1. This table shows the positions of the various switches to generate the letters of the alphabet in morse code.

↑ = Switch up

↓ = Switch down

— = Switch half way: no signal

## Parts list for figure 2

## Resistors:

R1 = R2 = 39 k  
 R3 = 4k7  
 R4 = R7 = 10 k  
 R5 = 820 k  
 R6 = 3k3  
 R8 = 1 k  
 R9 = 2k2  
 P1a + P1b = 2x 100 k log.

## Capacitors:

C1 = 1  $\mu$ /10 V  
 C2 = 2 $\mu$ 2/10 V  
 C3 = 1 n

## Semiconductors:

IC1 = 4017  
 IC2 = 4093  
 T1 = BC 516  
 D1 ..... D13 = DUS

## Miscellaneous:

S1 ..... S4 = Switch SPDT with center off  
 S5 = Pushbutton switch N/O single pole  
 S6 = Switch SPST  
 S7 = Morse key  
 LS = speaker, miniature 8  $\Omega$

There are four SPDT switches (S1...S4). Table 1 shows the various positions of the switches in order to generate morse coded letters.

All the morse signals may be created with various combinations of these switches. This excludes figures and other signs.

The printed circuit board is shown in figure 2, along with the parts layout. The four switches can be mounted on the board or at a remote location. If the audio output is too loud for your liking, a 50  $\Omega$  pot may be wired in series with the speaker. The output may also be wired to a set of headphones. This will allow for increased concentration, while reducing public irritation!

By connecting a sign key for S7, it is possible to use the trainer for transmission practice. If this feature is used, S5 is not depressed and IC1 is not used at all. By depressing the sign key, the supply voltage will be fed to the low frequency generator. This is accomplished via R8 and D13, causing it to generate a tone through the loudspeaker.

# the SC/MP as a mini organ

H.W. Wyes

Elektor's SC/MP system may be used to produce musical notes in the form of a two octave software organ. The hex keyboard functions as the manual. As there are not more than sixteen keys available, only whole tones may be produced, usually enough to play simple melodies. The software ensures that a squarewave is produced at the flag 1 output as soon as a key is depressed. This signal can then be amplified and reproduced through a loudspeaker interface (figure 1). This is the same system used for the 'Kojak Siren' and the 'Singing SC/MP'. As opposed to the 'Singing SC/MP', which sounded monotonous, the squarewave is modulated here. This produces a much more pleasant and interesting sound. The duty cycle (the ratio between positive and negative swings in a waveform) is varied.

The table (from 0F53 on) determines the pitch of the sound. At \$3 the hex-keyboard is continuously scanned to ascertain whether any keys are depressed. Using the extension register, the hexadecimal number concerned is added to the address indicated by pointer 3. At \$0, pointer 3 is loaded with the address of the table (0F53). Then at \$1 and \$2 the program for the tone generation actually begins. For the section of the waveform marked DOWN in figure 2, the program beginning at \$1 ensures that the required phase-shifting and frequency generation for the desired tones, is created.

The program in section \$1 runs until the counter has reached zero. Then

section \$2 is run. This controls the phase as shown in figure 2 (UP section). As you might have guessed, \$2 will run until the phase-shift returns to its original value.

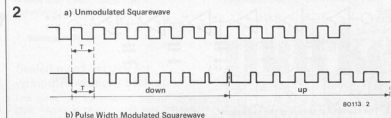
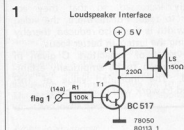

\$ 0
0F00 C40F LDI 0F
0F02 37 XPAL 3
0F03 C453 LDI 53
0F05 33 XPAL 3
\$ 1
0F06 C108 LD 08 (1)
0F08 943A JP \$ 3
0F0A C402 LDI 02
0F0C 07 CAS
0F0D C108 LD 08 (1)
0F0F 08 NOP
0F10 C201 LD 01 (2)
0F12 8F00 DLY 00
0F14 C408 LDI 08
0F16 07 CAS
0F17 C202 LD 02 (2)
0F19 03 SCL
0F1A FA01 CAD 01 (2)
0F1C 8F00 DLY 00
0F1E C108 LD 08 (1)
0F20 BA01 DLD 01 (2)
0F22 9CE2 JNZ \$ 1
\$ 2
0F24 C108 LD 08 (1)
0F26 941C JP \$ 3
0F28 C402 LDI 02
0F2A 07 CAS
0F2B C108 LD 08 (1)
0F2D 08 NOP
0F2E C201 LD 01 (2)
0F30 8F00 DLY 00
0F32 C408 LDI 08
0F34 07 CAS
0F35 C202 LD 02 (2)
0F37 03 SCL
0F38 FA01 CAD 01 (2)
0F3A 8F00 DLY 00
0F3C AA01 ILD 01 (2)
0F3E E202 XOR 02 (2)
0F40 9CE2 JNZ \$ 2
0F42 90C2 JMP \$ 1
\$ 3
0F44 C108 LD 08 (1)
0F46 94FC JP \$ 3
0F48 D40F ANI 0F
0F4A 03 XOR
0F4B C308 LD 08 (3)
0F4D CA01 ST 01 (2)
0F4F CA02 ST 02 (2)
0F51 90B3 JMP \$ 1

## TAB:

0F53 FA E7 D5 C2 B0 9F 8F 80  
 0F5B 72 65 59 4E 44 38 32 28

# the elekterminal width extender

It's getting wider all the time . . .

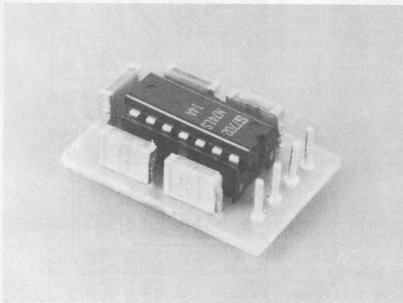

## W. Menzel

The elekterminal published in December 1978 meets the criteria set at that time. Users may, however, wish to adapt the row length to the screen width of the TV. This involves moving the beginning of a row to the left and adjusting the length of the row. With the elekterminal the dot clock generator is synchronized from the CRTIC with the aid of the  $\overline{NI}$ -signal. Between the sync and the  $\overline{NI}$  signals there is a fixed delay of  $11 \mu\text{s}$ . By reducing this period the picture may be moved towards the left. In figure 1 a simple circuit has been drawn in which the picture can be moved in this way. The

circuit is no more than a delay line with which the sync signal is delayed by  $4 \mu\text{s}$  on its way to the video combiner. As a result, the  $\overline{NI}$  and the sync signals are separated by about  $7 \mu\text{s}$ .

The screen width is adjusted by lowering the frequency of the dot clock generator with the aid of capacitor C2 on the elekterminal. This modification enables the width of the letters to be slightly increased, so that they are easier to read. Furthermore, the video bandwidth is then also reduced, thereby bringing the letters in better focus.

The values of capacitors C given in figure 1 need to be empirically established. The indicated value of  $1n5$  proved to work well in most cases.

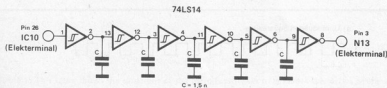

Figure 1. The circuit for delaying the sync signal.

## MPG meter

Due to unforeseeable circumstances we have not been able to publish the fuel consumption meter as announced on the contents page in the last issue. The type of transducers required by the circuit are not available at present — contrary to assurances made to us — and we are therefore endeavouring to modify the circuit, so that a more readily obtainable type may be used. The finished result will be published as soon as possible.

## junior computer sticker

A special sticker is available for the Junior Computer to increase display readability. It is made from red, transparent celluloid and can be affixed onto a perspex plate. This may then be fitted on top of the display printed circuit board with the aid of four bolts and spacers.

The words 'ADDRESSES' (left four displays) and 'DATA' belong to the normal use of the JC; 'OP-CODE' (left two displays) and 'OPERAND' (right four displays) are for editing and assembling.

The sticker is delivered free with the EPS printed circuit boards for the JC. Those of you who have already got a JC board may apply for the sticker in writing (please enclose a stamped addressed envelope).

We would also like to point out that a complete kit of parts (including the programmed 2708) is available from Technomatic Ltd. Details are given in their advertisement on page UK 27.

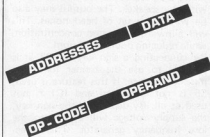



# missing link

**Modifications to Additions to Improvements on Corrections in Circuits published in Elektor**



## Topreamp

Elektor 56, December 1979 page 12-13. The negative voltage regulator, IC5, is shown the wrong way round on the component layout and the printed circuit board. The flat side of the regulator should face towards the centre of the board.



## Latest from the courtroom

People vs Elekterminal (December 1978, page 12-16). Resistor R7 of the RS 232 interface input stands accused of attempted arson, on a number of separate occasions, due to overheating. Under cross-examination, Elektor design staff have admitted that it was their responsibility and have satisfied the court that this behaviour will not be repeated by promising to increase the rating of R7 to 1 Watt. 'This', they say 'will enable R7 to conduct its current duties more easily without getting hot under the collar'.



## Active car aerial

Elektor 60, April 1980 page 4-24. In the drawing (figure 2), one half of switch S1 (thus, S1a or S1b) is shown in the wrong direction. As shown in the schematic, the power supply for the AM section is enabled when FM signals are to be received. The printed circuit is correct.

In figure 4, the BF 900 is drawn correctly but has incorrect lead designations, G1 and G2 in the circuit diagram should read G2 and G1 respectively, and of course the source and drain labels should be changed over as well.



## Coils and filters

The MC 120 series of coils is a new addition to the present Toko range of moulded VHF coils stocked by Ambit. Values from 30 nH to 440 nH with a Q of up to 200 at 100 MHz are available, as are the optional screening cans. Ambit now stocks a complete range of four of the most frequently used series of these moulded coils together with the necessary technical information.

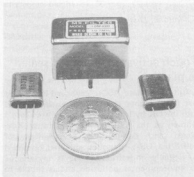

Ambit's range of crystal filters has also been extended to include a 34.5 MHz unit for applications as the first filter in HF receiver equipment, and an 8-pole monolithic 2.4 kHz bandwidth SSB filter, centred on 10.7 MHz. The latter is available with the appropriate upper and lower sideband crystals.

Ambit International,  
200 North Service Road,  
Brentwood, Essex, CM14 4SG.  
Telephone: (0277) 23909.

(1570 M)

## Sealed nicad battery for computer memory back up

The value of information stored in solid state memories often means that loss due to power supply failure would be catastrophic.

Symot Limited now offer the 'Memory Mount' sealed nickel cadmium battery, model number P-2M11, manufactured by Matsushita Battery Industrial Company Ltd. This battery unit is designed for PCB mounting in close proximity to the memory and measures 23.5 mm x 16 mm x 48 mm. Weight is only 22 gm.

The P-2M11 has a nominal voltage of 2.4 V and a capacity of 110 milliamp hours is claimed. The standard charging rate is 11 milliamps for 15 hours and at, for example, 1 milliamp discharge rate, voltage is maintained for over 4 days.

At 100 microamp discharge rate, voltage is maintained for over 40 days (at 20°C) or over 25 days (at 45°C). This means that the memory mount battery unit is especially suitable for memory unit transportation on relatively long journeys.

Symot Limited,  
22a Reading Road,  
Henley on Thames,  
Oxon RG9 1AG,  
Telephone: (049 12) 2663.

(1655 M)

## IC pin headers

The full AP range of male and female headers is now available from Lektrokit. They are all based on 0.10" centres and are available in strips of 36, either single or double row. The headers are stackable to maintain 0.10" row to spacing and have a 'break to length' feature

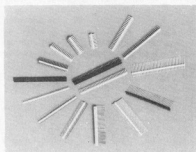

which allows the making of shorter rows. Contacts are made of full hard copper alloy 770 which are moulded into thermoplastic polyester and the dual row headers are ultrasonically welded together. Built-in stand-offs facilitate wave soldering and board cleaning.

Female headers have 'tuning fork' contacts to ensure excellent electrical connection and mate with matrices of 0.025 square or round posts on 0.10 centres. The solder tails are seized for P.C. board mounting.

Male headers are available in both straight and right angle configurations and have tail lengths suitable for either p.c. board mounting or wire-wrapping.

Elektrokit LTD,  
Sutton Industrial Park,  
London Road,  
Early, Reading, Berks RG6 1AZ,  
Telephone: (0734) 669116/7.

(1571 M)

# market

W.S.I. K.G.A.

# market

## Modular input/output system

New from Hamlin Electronics is a range of solid-state input/output modules and systems designed to provide a simple interface between microprocessors and similar logic devices and the circuits being controlled. The total Hamlin system, consisting of four basic optically coupled, colour-coded modules and three plug-compatible printed-circuit modules with barrier strips, replaceable fuses and status indicators, is designed to interface with any 5 V logic family, and provides the user with maximum flexibility during installation, operation and maintenance.

The four basic modules in the Hamlin system are IDC5 (DC input), IAC5 (AC input), ODC5 (DC output) and OAC5 (AC output). The standard output devices require a nominal drive voltage of 5 V DC, but modules are also available for use with 15 V and 24 V DC logic families. The AC output unit provides a peak repetitive blocking voltage of 400 V AC or a peak intermittent blocking voltage of 600 V AC, making it suitable for operation with 240 V AC loads.

All the modules feature 2.5 kV AC optical isolation, high transient-noise immunity and excellent surge protection. Zero-voltage switching is provided on the AC output unit, and all the modules will operate over a temperature range of  $-40^{\circ}\text{C}$  to  $+80^{\circ}\text{C}$ .

The three printed-circuit modules in the Hamlin input/output system provide four, eight or 16 mounting positions. An industrial-type barrier strip with a straight forward plug-in system allow modules to be changed without disturbing any wiring. Logic-signal inputs are via a 50-pin ribbon-cable connector which is plug-compatible with all microprocessor boards, and the mounting racks are

universal, allowing any module to be used in any position.

Individual plug-in fuses on the mounting boards protect the modules and the power wiring against short circuits, and a light-emitting-diode status indicator alongside each module simplifies programming, setting up, and troubleshooting. A pull-up resistor is also provided to simplify customer circuitry.

Hamlin Electronics Europe Ltd.,  
Diss,  
Norfolk IP22 3AY.  
Telephone: Diss (0379) 4411/2/3.

(1558 M)

## Touch activated keyboard sealed in plastic

A fully solidstate ASCII keyboard measuring just 0.325 inches thick has been introduced into the UK by Interface Components Ltd. Known as the TASA Micro-Proximity Keyboard and designed by TASA Inc. of California, USA, the touch activated keyboard is virtually indestructible. It is impervious to environmental pollution and is simple to hook up to any computer.



The TASA keyboard is a thin rectangular board with a totally flat surface. The micro-proximity touch sensors are protected by a shield of tough polycarbonate which can be kept clean by wiping with a damp sponge. Because it can be easily cleaned and disinfected, it is ideal for sterile environments, such as hospitals. It also can be used in hostile environments where dust, temperature extremes, moisture, chemicals or radio frequency interference are a problem.

Measuring 6.25 in. deep by 15.05 in. wide by 0.325 in. thick the TASA keyboard has a full 128 position 8 bit ASCII output plus continuous strobe, parity select. Other features include:

- Built-in electronic shift lock;
- Two-key rollover to prevent accidental two-key operation (excluding 'control' and 'shift');
- Electronic hysteresis for firm 'feel';
- Signal activation time of 1 millisecond;
- Output via 12-way edge connector;
- CMOS compatible with pull-up resistor;
- Parallel output: active pull-down, direct TTL compatible (one load) open collector type.

Interface Components Ltd.,  
Oakfield Corner, Sycamore Road,  
Amersham, Bucks.  
Telephone: (02403) 5076.

(1561 M)

## 60 GHz portable spectrum analyser

A new high-performance portable spectrum analyser from Tektronix, the Model 492,

covers a frequency range from 50 kHz to 60 GHz and features an internal microprocessor-based digital control system which makes the instrument simple to use. The Model 492 uses phase-lock stabilisation and has a resolution of 100 Hz, permitting precise signal analysis, while the instrument's dynamic range of 80 dB enables very small signal responses to be examined.

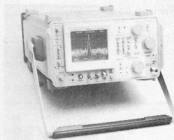

The use of digitally refreshed storage and internal digital signal processing enables relevant parameters to be displayed directly in alphanumeric form on the cathode-ray tube; these include major control settings such as reference level, frequency, vertical display, frequency span, frequency range, resolution, bandwidth and r.f. attenuation.

The Model 492 is a truly portable instrument, measuring 175 x 327 x 500 mm and weighing 18 kg, and the rugged case offers environmental protection to the MIL-T-28800B standard. As a stand-alone instrument, the Model 492 can measure signals in the frequency range 50 kHz to 20 GHz, and with suitable external mixers the upper limit is extended to 60 GHz. Provision has also been made to extend this still further to 220 GHz using mixers and down-conversion techniques.

Internal preselection prevents unwanted responses reaching the display at up to 21 GHz, and the phase-lock circuitry permits a 100 Hz resolution filter to be used at 18 GHz.

Although the front panel has been designed for ease of use by engineers familiar with the analogue controls on conventional spectrum analysers, all the major controls convey digital instructions to the internal microprocessor. An input signal is passed through the r.f. chain under strict supervision from the microprocessor, and the final detected signal is digitised and fed into a formattable memory whose contents are then displayed in refreshed form on the cathode-ray tube. For users who require full programmability, a General Purpose Interface Bus to the IEEE 488 (1978) standard is available.

Tektronix U.K. Ltd.,  
Beaverton House,  
P.O. Box 69,  
Harpenden, Hertfordshire.  
Telephone: Harpenden 63141.

(1569 M)

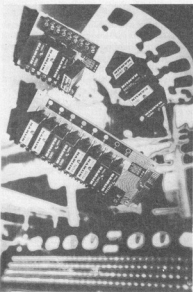

# market

# market

## New Beckman digital multimeter

The new 3020 3½ digit liquid crystal multimeter from Beckman Instruments includes many unusual features including instant continuity display and 2000 hr battery life. Five DC voltage ranges cover 200 mV to 1500 V full scale; five AC voltage ranges cover 200 mV to 1000 V full scale. Six AC and DC current ranges cover 200 Ω to 2 MΩ full scale. Low power ohms ranges permit in-circuit measurement without turning on junctions, while a separate semiconductor test function provides a 5 mA test current to verify junction operation. Input impedance is 22 MΩ and frequency range up to 10 KHz. A basic accuracy of 0.1% + 1 digit applies to all DC voltage ranges. The 'Insta-ohms' test indicator allows rapid continuity checks by displaying an ohms symbol in less than 1 ms. All inputs are comprehensively protected against overload.

*Toolrange Ltd.,  
Upton Road,  
Reading RG3 4JA.  
Telephone: (0734) 29446 or 22245*

(1527 M)

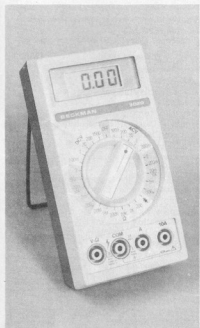

## 'Jumbo' neon displays

Impetrons range of electronic and electrical components now include a brand new range of large digital neon indicators.

The indicators are flat for high packing densities, and produce bright neon-orange seven segment displays, with decimal point, on a mattblack background. Two sizes are available: the NEO-8000 has a character height of 80 mm, while the NEO-5000 has a character height of 50 mm. Overall package dimensions (excluding pins) are 130 x 80 x 9 mm and 92 x 54 x 6.5 mm (H x W x D) respectively. The displays are designed for either PCB or socket mounting and are capable of operating between -10 and +60°C. Peak anode supply voltage is 190 V and peak anode currents around 5 mA.

*Impetron Ltd.,  
Foundry Lane,  
Horsham,  
W. Sussex. RH13 5PX.  
Telephone: 0403-50111*

(1524 M)

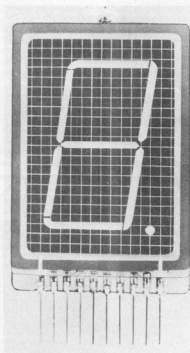

## Modular desk-top micro system

Nascom Microcomputers have recently launched a desk-top microcomputer system called System 80 which combines many of the company's well known products with a number of new boards and peripherals. System 80 is totally flexible and with the exception of the IMP (impact matrix printer) which is only supplied ready-built, all the products can be supplied ready-made or in kit form.

System 80 is based on the Nascom 2 microcomputer. This 4 MHz Z80A powered single board microcomputer is supplied with interfaces for TV or video, cassette (1200 Baud Kansas City type), keyboard, and printer (serial RS 232). It is fitted with an 8k Micro-soft BASIC, 1k NAS SYS operating monitor and 128 character ASCII plus graphics - all in ROM. The board has eight, free,

24 pin sockets - all with link-option - for the user to fit whatever compatible firmware he wishes. This currently allows a choice between 2708, 2716, 2508, 2516, TMS2516, 2532, 2758 and 2732 EPROMS. Using 2716 EPROMS alone provides over 16k of firmware.

Within the System 80 housing is a frame rack that holds a NAS BUS motherboard, a power supply (3 amp or 5 amp depending on the choice of boards to be fitted), the CPU board, and up to four 8" x 8" expansion boards. Provision is made for external connection direct to the boards concerned. The Nascom 2 keyboard fits snugly in the cutout provided. The housing is moulded from glass reinforced plastic, which combines lightness with strength, and is available in a choice of colours. A TV or monitor can be placed on top of the housing - however this surface has been designed with recesses to

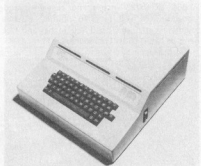

accept the feet of an expansion housing which is being designed to hold five more boards.

Parts for the System 80 floppy disc system can be bought individually or it can be supplied complete. Included is an assembled controller card (which can control up to four drives), power supply unit, 5½ in double sided, double density drives, enclosure and accessories for mounting two drives and the power supply. The industry standard CP/M disc operating system will also be available. Each drive provides 280 k bytes of formatted storage.

Other new products for the System 80 include a random access memory board which can be supplied with 16 k, 32 k or 48 k of MK 4116 dynamic RAM, a high resolution programmable character generator board, low and high resolution colour graphics boards, and a motherboard which will accept up to twelve extension boards.

*Nascom Microcomputers Ltd.,  
92 Broad Street,  
Chesham,  
Bucks.*

*Telephone: (02405) 75155.*

(1525 M)

# market

# market

# market

## Hobbyist spring kit

For hobbyists, model-makers and do-it-yourself enthusiasts, a new Instrument Spring Kit containing 216 cadmium-plated music wire springs in 108 different sizes, has been introduced by Lee Spring Ltd. Packaged in a compact, pocket-size plastic box, the kit comprises compression, extension and torsion springs, compartmentalised separately and instantly identifiable. On the inside lid of the box is a detailed specification-sheet with easy to read and locate data on each of the three types of springs. Springs in this list range from 0.006 to 0.026 inches and come in load-capacities of 0.3 to 6.75 pounds, outside diameters of 0.057 to 0.360 inches and free lengths of 0.125 to 1.25 inches.

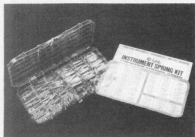

For those who do a lot of work in the home, these kits offer a cross-section of springs for every conceivable purpose with which to save time and avoid inconvenience in hunting high and low for springs that cannot be found when they are needed, or rushing off to the local shops in search of springs which they may or may not stock.

The Instrument Spring Kit from Lee Spring Ltd. costs £25.00.

Lee Spring Ltd.,  
Cornwallis Estate, Maidenhead,  
Berkshire.  
Telephone: (0628) 32316.

(1553 M)

## Self-adjusting wire stripper

Developed as a result of 12 years expertise and three years of field tests, AB Engineering's new MK 2 FC wire stripper marks a new step in tool design and operation.

Ergonomically designed to multiply the force exerted by the hand and light in weight — only 150gms. — the new model is constructed in glass fibre reinforced polyamide with high tensile steel moving components.

The MK 2 FC features a novel 'floating clam' which automatically adjusts the jaws to the correct stripping depth and simultaneously adjusts the gripping pressure on the insulation. This invention (world patents applied for) prevents damage to the insulation as the pressure exerted when stripping fine wires is reduced to the minimum. For larger wires, the gripping pressure automatically increases. It features the 'Flexi Jaw' patented cutting edge system. Top and bottom jaws incorporate a number of independent leaf blades

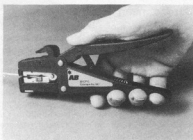

mounted on resilient pads. In operation, the jaws close and the resilient pads are depressed to allow the leaf blades to conform precisely to the wire shape to be stripped. The cutting edge actually surrounds each conductor to ensure the insulation is cleanly stripped away without damage. An integral, self-sharpening wire cutter is fully shielded to prevent accidental injury and the blades are easily exchangeable.

Replaceable metal jaw inserts ensure continued excellent performance and allow for the interchange of jaws for specific applications — flat wires, etc. These jaws are guaranteed for more than 200,000 operations. The new model incorporates front feeding of wires, an adjustable length stripping step and is self-adjusting through a range of wire thicknesses from 0.25 mm<sup>2</sup> to 4.00 mm<sup>2</sup> and is capable of stripping multi-core cables up to 5 mm in diameter.

AB Engineering Co., Timber Lane,  
Woburn, Beds. MK17 9PL.  
Telephone: 052525 322/3/4/5.

(1554 M)

## Piezo/acoustic resonators

Toko has recently introduced a range of miniature piezo-ceramic 'sound-transducers' for all types of electronic equipment requiring acoustic information — such as alarm buzzers, keyboard entry verification etc.

These buzzers are available as mounted discs, or encapsulated in a small plastic enclosure (as illustrated). The type PB-2720 produces > 85 dB SPL with as little as 1 mA drive current, at the resonant peak of 4.5 kHz.

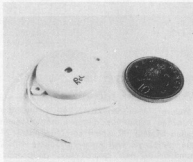

However, these units are fully specified with regard to broadband response characteristics — e.g. the SPL at 1.5 kHz is typically 77 dB with a 10 V p-p squarewave drive. A wide range of application and drive circuits is included in the product data, which is available along with the devices from AMBIT.

Ambit International,  
200 North Service Road,  
Brentwood - Essex, CM14 4SG.  
Telephone: (0277) 230909.

(1556 M)

## High-temperature display fluid operates at low voltages

The Hamlin Electronics range of liquid-crystal displays is now available with a new fluid, Type 0.6, which offers high-temperature operation at low drive voltages, making it suited to outdoor use in marine, automotive, agricultural or petrochemical applications. Designed for operation over the temperature range from -10°C to +90°C, the Type 06 fluid requires a drive voltage of only 4.5 V r.m.s. for good contrast and viewing angle.

The Hamlin Type 06 fluid offers a high degree of stability, and is designed for use in conjunction with high-stability K-sheet polarisers, allowing storage to 90°C in dry heat and 50°C at 95% relative humidity. Speed of response is 45 ms when turned on and 75 ms when turned off. The maximum drive voltage is 13.5 V.



The new high-temperature fluid is available on all the standard Hamlin ranges of liquid-crystal display devices in both reflective and transmissive configurations.

Hamlin Electronics Europe Ltd.,  
Diss,  
Norfolk IP22 3AY  
Telephone: Diss (0379) 4411

(1555 M)

## New hobbyist catalogue

Designed to a new format, a 52 paged Hobbyist Catalogue has recently been released by Vero Electronics.

The brochure contains a selection of products that are particularly useful to the home constructor.

Several new products are illustrated including Verobloc; a new prototyping method of building and testing circuits; S100 bussing system; a rack mountable development kit for evaluation of micro-processor based systems to the S100 format and Low Profile DIP Sockets.

Send 40p to cover post and packing and this new catalogue is yours.

Vero Electronics Limited,  
Industrial Estate,  
Chandler's Ford,  
Eastleigh,  
Hampshire, S05 3ZR  
Telephone: (042 15) 69911.

(1564 M)

# market

# NEW

**formant**  
music synthesiser

CONTAINS COMPLETE DETAILS OF THE ELEKTOR FORMANT SYNTHESISER

SENT TO YOU WITH A FREE CASSETTE OF SOUNDS THAT THE FORMANT IS CAPABLE OF PRODUCING

Designing, Constructing and Servicing Electronics  
C. Chapman  
Longway Subscribers Ltd

FOR DETAILS OF PRICE, ETC. SEE ORDER CARD

# ORDER NOW

You've heard about it  
Read about it — HERE IT IS

AVAILABLE EX-STOCK  
COMPLETE KIT AS PER  
MANUFACTURER'S SPECIFICATION

With provision for 8K on board expansion. Excludes 4118 + 8+

INCLUDES FREE 16K EXPANSION  
VALUE £140 includes ALL parts with every kit

**NASCOM-2**  
ON DEMONSTRATION NOW

£295 +15% WITH  
VAT FREE  
16K EXPANSION WORTH £140

AVAILABLE ONLY FROM US ON THE COUPON BELOW

OPTIONAL EXTRAS  
**3 AMP POWER**  
SUPPLY VAT 15%  
£29.50 Post £1.50  
For NASCOM-2

8 OFF 4118\*  
For NASCOM-2  
Purchasers  
only £80  
Early Delivery

RS232 COMPATIBLE **NASCOM IMP** OUR PRICE  
**80 COLUMN PRINTER** brand new **£325** + VAT  
List price £550 If sent by carrier £5 extra 15%

FULL MANUFACTURER'S WARRANTY — DON'T DELAY, ORDER TODAY

Please send me my NASCOM-2 KIT with the FREE 16K EXPANSION for £295 + VAT.

I enclose remittance . . . . . to cover

Name & address . . . . .

. . . . .

. . . . .

Also in stock NASCOM-1 • ELF • TRS80 as previously advertised



## HENRY'S

Computer Kit Division  
404 Edgware Road, London, W2, England  
01-402 6822



## services to readers

### EPS print service

Many elektor circuits are accompanied by printed circuit designs. Some of these designs — but not all — are also available as ready-etched and predrilled boards, which can be ordered from any of our offices. A complete list of the available boards is published under the heading "EPS print service" in every issue. Delivery time is approximately three weeks.

It should be noted, however, that only boards which have at some time been published in the EPS list are available; the fact that a design for a board is published in a particular article does not necessarily imply that it can be supplied by elektor.

### Technical queries

Please enclose a stamped, self-addressed envelope; readers outside U.K. please enclose an IRC instead of stamps.

Letters should be addressed to the department concerned: TQE = Technical Queries. Although we feel that this is an essential service to readers, we regret that certain restrictions are necessary:-

1. Questions that are not related to articles published in elektor cannot be answered.
2. Questions concerning the connection of elektor designs to other units (e.g. existing equipment) cannot normally be answered, owing to a lack of practical experience with those other units. An answer can only be based on a comparison of our design specifications with those of the other equipment.
3. Questions about suppliers for components are usually answered on the basis of advertisements, and readers can usually check these themselves.
4. As far as possible, answers will be on standard reply forms.

We trust that our readers will understand the reasons for these restrictions. On the one hand we feel that all technical queries should be answered as quickly and completely as possible; on the other hand this must not lead to overloading of our technical staff as this could lead to blown fuses and reduced quality in future issues.