

up-to-date electronics for lab and leisure

# ELEKTOR 5

*Summ. 75*

# Summer Circuits

July-August 1975  
double issue - 70p

# 75

with  
more than  
100  
circuits



# contents

Phone 367459  
**PRECIOUS ELECTRONICS CORPN.,**  
 3, Chhatrapati Lane,  
 Lamington Road,  
 BOMBAY-7.

About this issue . . . . .	p. 709	traffic news indicator . . . . .	33
IC lists . . . . .	p. 753	tv-sound channel, IC . . . . .	77
TUP-TUN list . . . . .	p. 756	ultrasonic detector . . . . .	65
<b>AF</b>	<b>nr.</b>	<b>Power supplies</b>	<b>nr.</b>
amplifier for 1.5 volt supply . . . . .	19	astereo power supply . . . . .	48
amplifier, 6.5 watt IC . . . . .	94	battery stand-by circuit . . . . .	58
astereo control amplifier . . . . .	44	heatsink shrinker . . . . .	87
astereo disc preamplifier . . . . .	45	rhythm generator power supplies . . . . .	40
astereo power supply . . . . .	48	slow-rise power supply . . . . .	84
astereo 3 watt amplifier . . . . .	46	voltage regulator, wide range . . . . .	5
astereo 15-30 watt amplifier . . . . .	50	voltage stabilizer as current source . . . . .	18
diode, ideal . . . . .	23	+/0— from one winding . . . . .	34
filter, active low-pass . . . . .	101	<b>Sundries</b>	<b>nr.</b>
frequency dependent resistor . . . . .	4	afterburner . . . . .	13
generator, diac sawtooth . . . . .	95	alarm circuit . . . . .	11
generator, staircase . . . . .	8	calculator doubles as stopwatch . . . . .	49
inductance, variable . . . . .	78	capacitance meter . . . . .	98
mixer, FET . . . . .	7	car lights failure detector . . . . .	15
oscillator, 1 kHz . . . . .	81	conductance tester, mini siren . . . . .	82
overmodulation indicator . . . . .	36	contrast adapter . . . . .	100
signal squirt, mini . . . . .	99	cuff links . . . . .	42
siren, 7400 . . . . .	31	curve tracer . . . . .	30
tremolo, LED controlled . . . . .	90	dark room exposure timer . . . . .	93
volume control, fingertip . . . . .	97	direction pointer . . . . .	85
volume, voltage-controlled . . . . .	96	economic flashlight . . . . .	64
<b>Digital</b>	<b>nr.</b>	economic relay . . . . .	59
arithmetic teacher . . . . .	56	FET $\Omega$ adapter . . . . .	60
capacitance meter . . . . .	98	'find me' flashlight attachment . . . . .	83
clock suppression . . . . .	28	flasher, LED . . . . .	79
decimal to 7-segment converter . . . . .	1	flasher, LED, for higher voltages . . . . .	80
display input selector . . . . .	51	flasher, triac . . . . .	6
divider, programmable frequency . . . . .	92	fluorescent lamp dimmer . . . . .	62
division by 2, 5 and 10 . . . . .	66	frequency meter, analogue . . . . .	61
division by 3 . . . . .	67	fuse destroyer . . . . .	89
division by 4 . . . . .	68	hum receiver . . . . .	54
division by 6 . . . . .	69	key contacts for organs, gated . . . . .	52
division by 7 . . . . .	70	LED display dimmer . . . . .	57
division by 8 . . . . .	71	mostronome . . . . .	47
division by 9 . . . . .	72	opto-coupler for mains sync . . . . .	43
EXOR . . . . .	3	oven, mini- . . . . .	24
EXOR . . . . .	35	rhythm generator M 252 . . . . .	38
four-channel switch . . . . .	63	rhythm generator M 253 . . . . .	39
frequency reference, universal . . . . .	12	rhythm generator power supplies . . . . .	40
interference rejector . . . . .	32	running light . . . . .	17
NAND-NOR gate . . . . .	41	service meter, auto . . . . .	20
NAND-OR gate . . . . .	86	speed controller, triac . . . . .	55
NOR-AND gate . . . . .	9	temperature monitor . . . . .	75
pulse multiplier . . . . .	37	tester . . . . .	14
reset for TTL, automatic . . . . .	29	tester, p.c.board and wiring . . . . .	53
seven segment abc . . . . .	21	thermometer . . . . .	27
seven segment for MOS-clocks, improved . . . . .	91	timer, kitchen . . . . .	2
time signal simulator . . . . .	74	trigger, 555 as a . . . . .	16
the 74121 . . . . .	76		
use of 7493 instead of 7490 . . . . .	73		
<b>HF</b>	<b>nr.</b>		
FM detector with ceramic filter . . . . .	10		
mono/stereo indicator . . . . .	26		
receiver, sensitive coil-less . . . . .	22		
selective amplifier . . . . .	25		
stereo decoder, CA 3090 AQ . . . . .	88		

# Summer Circuits

## 75

### about this issue

... containing over a hundred 'Summer Circuits'. It doesn't sound too difficult, until you start trying to find a sufficient number of interesting designs in time to meet the printers' deadline. . . .

The requirements which must be fulfilled are originality, quality and quantity. Finding the requisite 100 circuits starts to become a real problem when some 100 circuits have been rejected. A design can be labelled 'unsuitable for

publication' on many grounds, but the most frequent one is that what seems to be an original idea at first sight turns out to be not so original, or else can not (yet) be made to meet the required specifications.

Some of the designs published in this issue are based on manufacturers' application notes, for which we thank all concerned. Originally, it was also the intention to publish several designs using LSI chips (large scale integration). However, a closer analysis of the types recommended to us by the major manufacturers showed that most of them were either too complex to describe in the space available in this issue, or too expensive, or not (yet) readily available.

Perhaps it should be made clear that this issue is not a review of circuits

already published, nor is it a preview of designs that will be published in the coming year. Of course the designs are not all equally original, and of course some of the most interesting ones may be dealt with in greater length as (part of) a new design in a future issue, but in general it is the intention that this issue should be a useful collection of design ideas that will retain its value at least until next year's 'summer circuits' issue is published. We hope that we have succeeded in achieving this goal.



2

J. Wittje

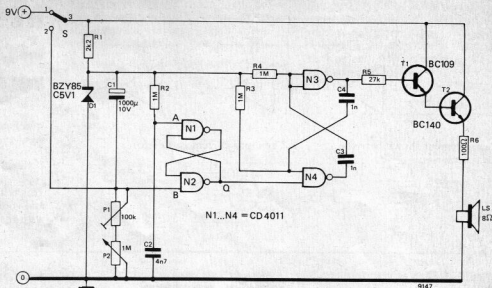
kitchen  
timer

Battery or mains-synchronous kitchen clocks usually have dials large enough to enable short time intervals of a few minutes and fractions thereof to be clearly read (except when they happen to be steamed up), but few have any 'alarm' system to give an audible warning when a preset time interval has elapsed. The timers built into electric (or nowadays gas) cookers supposedly have this facility, but they are not much use for short-interval timing because the scales are either non-existent or very small, the setting dial is mechanically difficult to handle, the termination point of the timing interval is ill-defined, and at least one well-known make is calibrated in quarters of five minutes - i.e. in 1¼-minute intervals. These may be good enough for baking a cake but they are of little help to the blancher of twenty successive batches of runner beans, each to be immersed in boiling water for 2 minutes 45 seconds. For this reason it was suggested that an electronic timer should be developed, possibly using valves. However, the technical staff felt that the best way to use these would be to drill holes in them and fill them with sand.

The time switch described here can be constructed at very small cost, and is adjustable between 1 minute and 17 minutes. Other times are possible with small modifications.

Before switching on, capacitor C1 and C2 are uncharged. When the device is turned on with switch S (position 1), input A of flipflop N1/N2 remains briefly at '0', so that output Q of N2 becomes '0' and multivibrator N3/N4 is blocked.

Capacitor C1 charges through poten-

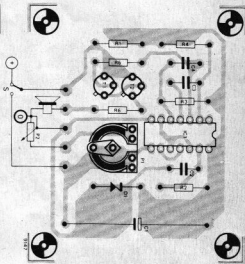
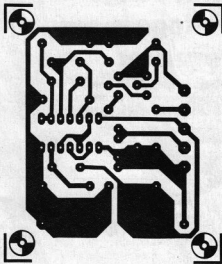

tiometers P1 and P2. When the potential at B drops below the flipflop changeover threshold, the flipflop switches over and the multivibrator is started. The resulting square wave is amplified by T1 and T2 and reproduced through loudspeaker L.

On switching off (S to position 2), capacitor C1 is discharged rapidly through resistor R1 so that, when the timer is once again switched on, there is no residual voltage which would shorten the timing interval.

Calibration:

1. Set P1 to the middle of its travel and P2 to minimum. Then readjust P1 to give a time of 1 minute.
2. Next set P2 to maximum and measure the time now given by the circuit.
3. Finally calibrate the scale of P2 linearly between 1 minute

(minimum) and the maximum time which has been determined.

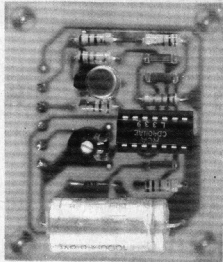

3

It is the simplicity of this exclusive OR-gate that makes its application instead of TTL-circuits so attractive. Its functions as follows. When both inputs are

unequal, the output signal is always HIGH. Equal input signals give a low output level because in that case both transistors are either 'on' or 'off', so that the output signal is governed by input A.

EXOR

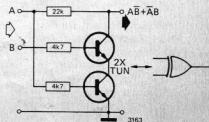

4

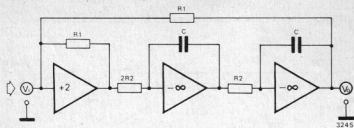

In the arrangement shown here the transfer function is:

$$\frac{V_0}{V_i} = \left(\frac{1}{j\omega\tau}\right)^2$$

in which

$$\tau = R_2 \times C$$

The input current is therefore:

$$I_i = \frac{V_i - V_0}{R_1} + \frac{V_i - 2V_i}{R_1} =$$

$$\frac{V_0}{R_1} = \frac{1}{R_1 \omega^2 \tau^2} \times V_i$$

## frequency dependent resistor

which means that the input impedance is:

$$Z_i = \frac{V_i}{I_i} = R_1 \omega^2 \tau^2$$

This is a real resistance - with current and voltage in phase - but increasing with the square of the frequency.

(Int. J. Electronics)

5

The main features of the circuit are:  
wide range output: 0.1 to 50 volts  
good load regulation: 0.005% between

0 and 1 amp  
good line regulation: 0.01%  
low output noise: better than  
250 microvolts.

The wide output range is made possible by the integrated circuit CA 3130, which remains effective with a zero volt input.

Furthermore, upward extension of the output range is made possible by the addition of T4 between the IC and the series pass transistor. The high gain thus obtained allows a high degree of regulation, and the T1/T2 Darlington pair gives a sufficiently high current amplification.

T3 is the output current limiter. When P1 is turned fully anti-clockwise, T3 will limit at 0.6 amps. The limiting circuit is inoperative when P2 is turned fully clockwise.

The regulator circuit proper works as follows. The integrated circuit CA 3130 compares the output voltage applied to the non-inverting input with a reference voltage applied to the inverting input. The output voltage of the regulator is stepped down in a potential divider to prevent damage to the IC. The reference voltage is set by P2, which should be a high quality component, as any noise on its wiper will be passed on to the regulator output terminals.

## wide range voltage regulator

A further integrated circuit, CA 3086, compensates the reference voltage for temperature changes. The IC contains

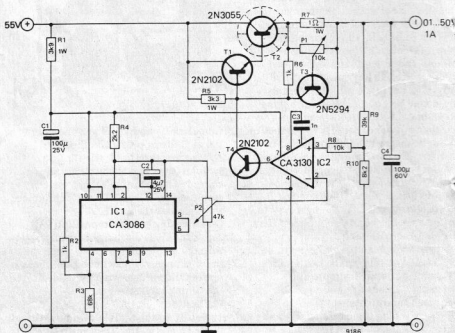

6

This circuit makes a standard incandescent lamp flash at a frequency that can be set between 2 and about 10 Hz. The mains voltage is rectified by a 1N4004 diode followed by an adjustable RC network. As soon as the electrolytic capacitor is charged up to the breakdown voltage of the ER 900

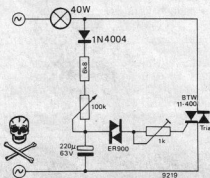

diac, it will discharge through the diac, which fires the triac and flashes the lamp.

After a certain period, set by the 100 k control, the capacitor will be re-charged to bring about a further flash.

The 1 k control sets the triac firing current.

(Transitron)

## triac flasher

## 7

Inexpensive junction-FETs such as the E 300 or U 1994 E — already popular in HF-circuits — can also often be applied advantageously to LF-circuits.

In a small audiomixer, for example, the use of JFETs leads to a great saving in components because of the relative simplicity of the biasing arrangements. The input impedance of each channel is determined only by the value of the potentiometer used.

## FET-mixer

## 8

F. Hebinck

A convenient way of generating a good 'staircase waveform' is to use a diode-transistor pump driven by a square wave as shown in figure 1.

Before the square wave is applied to the input, capacitor C2 is uncharged. Consequently, there is no voltage across it and transistor T3 is cut off because its emitter is at +10 V.

During the first positive going pulse, the diode conducts and capacitor C1 is charged to just under the peak value of the waveform (peak value minus the voltage across the diode). Because the diode prevents the emitter of T1 rising much above ground potential, the negative-going pulse drives the emitter negative by an amount equal to the peak value of the waveform less the voltage across the diode. Therefore T1 conducts and the voltage on its collector falls sharply. In other words, C1 is discharged and C2 is charged by an almost equal amount. (The difference is caused by the base current of T1.)

If C1 and C2 are equal, the voltage change across C1 will equal the change across C2 plus twice the drop across the diode. However, if C2 is much larger than C1, the change across it will be much smaller.

Capacitor C1 is charged again during the

The number of input channels can be considerably extended, if required, provided that the common drain load resistor (R1) is suitably chosen. Its value is the standard value closest to  $\frac{22k}{n}$ , where n is the number of input channels.

For other types of JFET it may be necessary to change the value of source resistor and/or the supply voltage. The frequency response of the circuit shown has -3 dB points at about 20 Hz and 80 kHz.

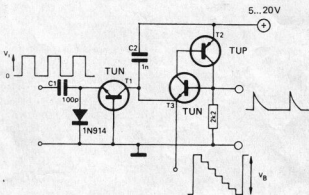
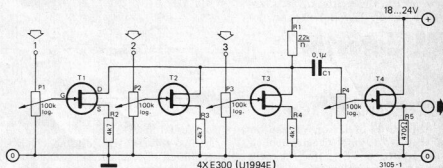

## staircase generator

next positive-going pulse. As T1 and T3 are not conducting, the charge on C2 cannot leak away and the voltage at T3 emitter remains constant. During the next positive-going pulse, more charge flows from C2 to C1 and the voltage on T3 emitter falls sharply again.

This process is repeated with the voltage on T3 emitter falling in a staircase pattern until it is negative. Transistor T3 then conducts, and positive feedback from T2 to T3 produces an avalanche effect that rapidly discharges C2. When C2 is discharged, the whole cycle starts again from the top of the staircase.

An approximate formula for the number of steps (n) is

$$n = \frac{C_2}{C_1} \times \frac{V_s}{V_w - 2V_d}$$

where  $V_s$  = supply voltage  
 $V_w$  = peak value of the square wave

$V_d$  = voltage across the diode  
Therefore, if C1 is 100 pF and C2 390 pF and the diode voltage 550 mV, the number of steps produced by the circuit in figure 1 is

$$n = \frac{390 \times 10}{100(5 - 1.1)} = 10.$$

The staircase waveform generator can be used in many applications, such as a D/A converter, frequency divider, driver for a transistor curve tracer, as well as to produce special sound effects and so on.

## 9

Three gates are needed for converting NOR-gates into an 'AND'-function. Figure 1 gives a TTL AND-gate consisting of three gates of a 7402. When inputs A and B are '1', so will be input C.

The circuit of figure 1 can be applied to any ordinary TTL-circuit.

Figure 2 shows a COS/MOS AND-gate consisting of three NOR-gates each with two inputs. Since the gates N1/N2 in

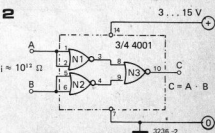
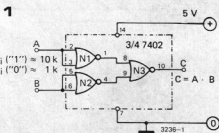

## NOR AND gate

both circuits are connected as inverters, several types of gate or inverter can be used, such as 7400 or 4011 gates or 7404 or 4007 inverters, for example.





12

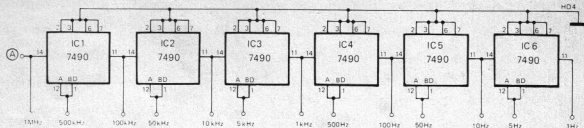

This circuit claims nothing in the way of originality, but is simply a useful, general-purpose board that can be used in many frequency and time measuring applications. It is particularly suitable for use as a gate pulse generator in frequency counters.

The heart of the system is a 1 MHz crystal oscillator based on two NAND-gates. The output of this oscillator is buffered by a third NAND-gate and the frequency is then divided down by a series of 7490 decade counters. These consist of a divide-by-2 stage followed by a divide-by-5 stage, which means that in addition to dividing the reference frequency down to 1 Hz in decades, outputs of 500 kHz down to 5 Hz are also available. These outputs are particularly useful where gate pulses for frequency counters are required. For example, the 5 Hz output will provide positive pulses of 100 ms width, so if the frequency of a 10 MHz signal were being measured a gate pulse this long would let through 100,000,000 cycles of the signal to the counter, giving a display of 1000000. On the other hand, for period measurements the 1 Hz to 1 MHz outputs are more useful. For example, when measuring a one second period, 1,000,000 cycles of the 1 MHz output can be counted, giving a display of 1000000.

The p.c. board layout is quite compact and well laid out. The outputs are available along the lower edge of the board as the diagram shows. There is one spare NAND-gate in the package used for the oscillator, and this may be used as the gate in frequency counter applications. The connections to it are brought out at the top right corner of the board.

The oscillator frequency may be trimmed to exactly 1 MHz by the trimmer capacitor. The best method of doing this is to use an oscilloscope to compare the 100 kHz output with the 200 kHz Droitwich transmissions, using

## universal frequency reference

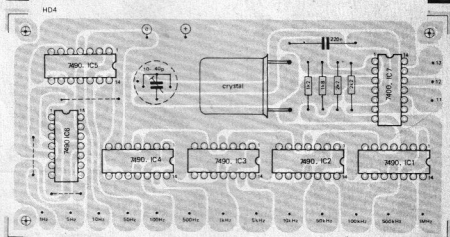
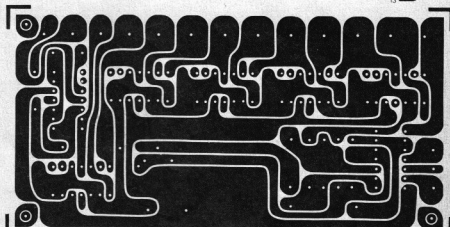
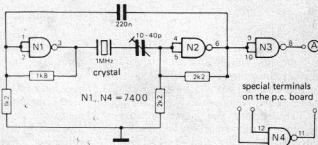

Lissajous figures. The trimmer should, of course, be adjusted until the

Lissajous figure apparently ceases to rotate.

13

W. Ferdinand

When starting a car journey after dark it is useful to have a device which will keep the interior lighting on for a while after the doors have been closed, and so make it easier for the occupants to fasten safety belts and insert the ignition key. This can be done with the simple time-switch circuit shown.

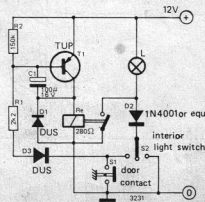

## afterburner

14

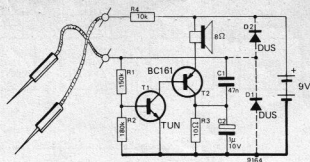

Passive testing of an electronic circuit seems quite a simple job. All you need is a resistance meter. Unfortunately, however, using such a piece of equipment for semi-conductors is not always such a good idea. The output currents are likely to damage semi-conductor junctions. The tester described in this article is easy to build and has the advantage that no more than about 50  $\mu$ A can be sent through the circuit under measurement. So it can be used for most conventional IC's and semi-

conductors, including MOS-components. The 'indicator' is a small loud-speaker, so that during testing, it is not necessary to keep looking at the measuring instrument instead of the measuring points.

The transistor T1 and T2 form a simple voltage-controlled LF-oscillator, with a loudspeaker as the load. The oscillator frequency is determined by C1, R1, R4 and the external resistance between the measuring probes. Resistor R3 is the collector resistance of T2; C2 serves for

low-frequency decoupling of this resistor.

As stated above, the tester will not damage a circuit under test; conversely, it is advisable to add diodes D1 and D2 so that the circuit under test will not damage the tester.

As long as there is no electrical connection between the measuring probes, the circuit draws no current. Battery life is then about equal to its shelf life.

(Based on Motorola application).

## tester

15

O. Dirnhirn

For people who wish to be sure that the lights on their car are in good order, this circuit is perhaps the solution. It is very simple and provides a reliable indication when one or more lamps fail.

Depending on the current through lamp L, a voltage drop occurs across resistance  $R_X$ . This voltage drop must amount to about 400 mV, and this determines the value of  $R_X$ .

For example, for the tail lights, where two lamps of 10 W/12 V are in parallel,  $R_X$  is calculated as follows:

$$\text{The current is } \frac{P}{V} = \frac{20}{12} = 1.67 \text{ Amp.}$$

$$R_X \text{ then becomes } \frac{V}{I} = \frac{0.4}{1.67} = 0.24 \Omega.$$

## car light failure detector

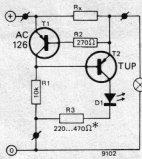

\* see text

Because of the 400 mV drop across  $R_X$ , T1 is normally turned on and T2 cut off.

If one of the tail lights fails, the current through  $R_X$  is reduced by half, that is 0.84 Amp. The voltage drop across  $R_X$  now becomes  $0.84 \times 0.24 = 0.2$  V. This voltage is too low to turn on T1, so that T2 now receives base current via R1, and the LED lights up.

To obtain a reliable indication when the lamps fail, it is recommended to use one detector circuit for not more than two lamps.

It is quite permissible, however, to use one LED for several detectors; D1 and R3 are common to all detectors, and the collectors of all 'T2's are connected together. R3 should be 470  $\Omega$  for a 12 V system and 220  $\Omega$  for a 6 V system.

16

The IC 555 is normally used as a timer. The time delay for these applications is obtained by charging and discharging a capacitor between two well-defined voltage limits. For this purpose the IC has two voltage-sensitive inputs, which can be used in a trigger circuit.

The input voltage is applied to pin 2; pin 5 receives a reference voltage from potentiometer P1. With this potentiometer the trigger threshold can be set between practically 0 V and half the supply voltage. The input impedance at point 2 is about 1 M.

The IC has two outputs, an open-collector output (pin 7) and an output (pin 3) which can deliver or sink a maximum of 100 mA. The output voltage is 'high' when the input voltage at pin 2 is below the threshold voltage. If the

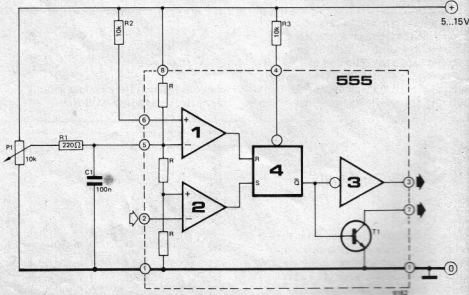

threshold voltage is exceeded, the voltage on pin 3 drops and T1 conducts.

(Electronics)

## 555 as a trigger

# 17

R. Kellenbach.

By means of this circuit four lamps can be made to light up sequentially, so that 'running-light' effects are obtained. The circuit consists of a square-wave generator (T1, IC1), a shift register (IC2, IC3), and the lamp driver stages. With P1 the frequency of the square-wave can be varied between 0.1 Hz and about 10 Hz. The square-wave voltage is fed to the clock inputs of the shift register. By closing S2 the flip-flops are reset. The Q-outputs then become '0' and the Q-bar-outputs '1', all LED's are

extinguished and no lamp is burning. After opening of S2, S1 is placed in position 1 so that the input of the register receives a '1'. After one clock pulse, the input information of the flip-flop is transmitted to the output and the first lamp lights up; S1 is now reset to position 2. Every following clock pulse shifts the logic '1' on to the next flip-flop and resets the previous one, so that the lamps light up in sequence.

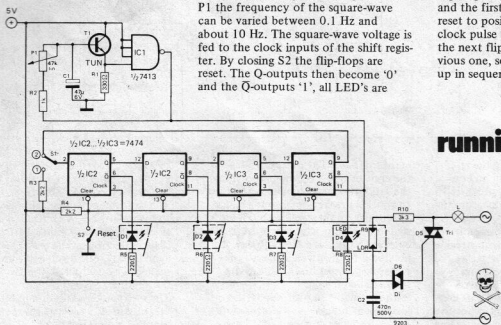

## running light

# 18

Integrated voltage stabilizers can also be used as current sources. The diagram shows an example of a current regulator using the IC LM 309 (5 V/1 A). The output current  $I_3$  of the circuit consists of the output current  $I_2$  plus the quiescent current  $I_1$  of the IC. The current  $I_2$  is determined by the output voltage  $V_2$  of the IC and the resistance  $R_1$ :

$$I_2 = \frac{V_2}{R_1}$$

The quiescent current  $I_1$  is always specified by the manufacturer of the IC. Provided that the quiescent current  $I_1$  can be neglected in comparison with  $I_2$  ( $I_1 \ll I_2$ ), the output current  $I_3$  will be constant ( $I_3 \approx I_2$ ) because it then depends only on the (fixed) output

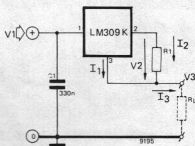

## voltage stabilizer as a current source

voltage of the IC and the (fixed) value of  $R_1$ .

For the circuit to work it is essential that there is a certain minimum voltage

difference between input and output of the circuit. This difference is determined by the minimum voltage difference between the input and output of the IC and by the output voltage of the IC:

$(V_1 - V_3)_{min} = (V_1 - V_2)_{min} + V_2$   
 The maximum voltage difference  $(V_1 - V_3)_{max}$  is equal to the maximum input voltage of the IC; similarly, the maximum output current is equal to the maximum output current of the IC. The following values apply to the IC LM 309 K:

$(V_1 - V_3)_{min} = 2.2 \text{ V} + 5.2 \text{ V} = 7.4 \text{ V}$   
 $(V_1 - V_3)_{max} = 35 \text{ V}$   
 $I_3 \text{ max} = 1 \text{ A}$

$$I_3 \approx \frac{5}{R_1} \text{ (A, } \Omega \text{) (at } I_3 \geq 100 \text{ mA)}$$

$$V_3 = I_3 \cdot R_L \approx 5 \cdot \frac{R_L}{R_1} \text{ (V)}$$

# 19

When existing amplifiers lack sufficient input sensitivity and no space is available inside their case, separate low power pre-amplifiers will come in handy. They should contain a minimum of components and preferably be fed from a single dry cell. The self-contained pre-amplifier described here consists of a single amplifying transistor preceding an emitter follower. DC negative feedback stabilises the working point. The gain will be approximately  $\times 10$  to  $\times 20$ . When the signal source has an im-

pedance of over 100 k ohms, some degree of gain control can be achieved by means of P1. Some long-term economy can be obtained by using two 1.5 volt dry cells

## amplifier for 1.5 volt power supply

(in series) instead of one. When the power supply drops below 1 volt the amplifier will cease working. Common dry cells often run down soon to 1 volt and must then be discarded, while it will take more time for each one of two cells

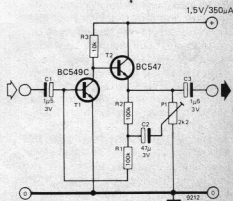

to run down to 0.5 volt. Power consumption at 3 volt supply will be about 450 microamps.

20

Chr. Wünsche

This handy portable instrument was designed as an aid to car servicing to be used in conjunction with a timing light for setting up a car ignition system for peak performance. It consists of a tachometer and dwell meter. The tachometer

## auto service meter

meter is useful for examining the ignition timing at various r.p.m. in conjunction with a timing light, or when used as a dwell meter it will measure the angle over which the contact breaker is closed and thus provide information about the setting of the contact breaker gap.

The circuit is shown in figure 1 and is intended for use with negative earth vehicles — which most modern cars are. It may, however, be adapted for positive earth vehicles by reversing all diodes and electrolytic capacitors, and by substituting TUP for TUN and vice versa. The circuit derives its power from the car battery.

The circuit operates as follows: T1 and T2 form a Schmitt trigger. As long as the contact breaker is closed T1 is turned off and T2 is turned on, which means that T4 is also turned on, so that a positive voltage equal to the supply voltage minus the base-emitter voltage of T4 appears at the emitter. When the contact breaker is open the input (R1) is connected to positive supply through the primary of the ignition coil, so T1 is turned on and the Schmitt trigger switches the other way. T4 is now turned off so the voltage appearing at its

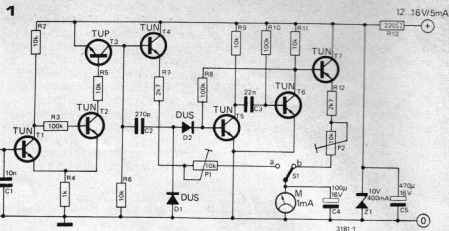

emitter is zero. The average voltage at the emitter of T4 is thus proportional to the ratio of contact-breaker-closed time to contact-breaker-open time i.e. it is dependent on the dwell angle. With switch S1 in the 'a' position the average current through the meter is also proportional to the dwell angle, so the meter may be calibrated linearly in terms of dwell angle.

With the switch in position 'b' the instrument functions as a tachometer. Pulses from the collector of T3 are differentiated by C2 and used to trigger a monostable consisting of T5 and T6. The monostable produces pulses of constant width, but as the r.p.m. increase the mark-space ratio of the pulses increases. The average voltage on the emitter of T7, and hence the average current through the meter, is dependent on the ratio of 'pulse' to 'no-pulse' time,

so as the r.p.m. increase and the pulses get closer together, the current through the meter increases linearly.

The instrument can be calibrated as follows: With S1 in position 'a' earth the input (R1) and adjust P1 to give full scale deflection of the meter. This corresponds to a 360° dwell angle and the scale can be calibrated linearly from 0 to 360.

The tachometer scale should be calibrated with full-scale as the maximum required r.p.m. For most applications 8000 should be sufficient. If the instrument is to be used with both four and six-cylinder engines, then either two scales are required, or S1 must be replaced by a three-position switch and P2 must be duplicated to calibrate one scale for different engines. The reason for this is that a six cylinder engine produces more pulses for a given r.p.m. The instrument may be calibrated using the simple circuit shown. This produces a 100 Hz waveform. This corresponds to 3000 r.p.m. for a four-cylinder engine and 2000 r.p.m. for a six-cylinder engine. The output of this circuit is connected to the input of the instrument and P2 is adjusted to give the correct deflection of the meter.

2

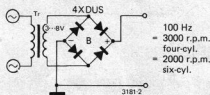

100 Hz  
= 3000 r.p.m.  
four-cyl.  
= 2000 r.p.m.  
six-cyl.

21

There are various alphanumeric display devices available to the electronics industry, but unfortunately their high cost places them outside the reach of most amateur constructors. However, one of our readers, Mr. P. Geist, has suggested that it is possible to use readily available seven-segment LED displays as alphanumeric indicators, and has proposed an alphabet using such displays.

As the display has seven segments, this means that  $2^7 - 1$  or 127 unique symbols may be displayed. Since 10 of these are the digits 0 to 9 this leaves 117 from which to choose symbols for the letters of the alphabet, plus other useful symbols such as parantheses. Since the range of shapes available with seven segments is limited, some of the characters are

kh 75 75 hoh

7t LooFS

seven  
segment  
ABC

necessarily rather stylised. Nevertheless they are unambiguous and are easily read after a little practice. After all, the figure 4 in a seven segment display is

stylised, yet this has gained wide acceptance, so there is no reason why the seven-segment alphabet should not prove popular.

a b c d e f g h i j k l  
 abcdefghijkl  
 m n o p q r s t u v w x y z  
 mnopqrstuvwxy z

# 22

This little receiver tunes the medium and long wave-ranges. It operates without any coils by employing a synchronised oscillator.

When the oscillator is barely able to maintain oscillations, it will synchronise to an incoming signal frequency close to its free-running value. The amplitude of

the oscillation follows, more or less linearly, the modulation of the incoming signal. The circuit can synchronise itself to a signal of some tens of microvolts, so that its effective sensitivity is very high.

P4 sets the level of oscillation; the stereo-ganged pair P2 and P3 form the 'tuning' control. Since this stereopotentiometer covers a very wide range it may be necessary to add a 'fine' control consisting of a low-value stereopotentiometer in series (typically 1 k or

500 ohm).

The modulated oscillator signal is passed to the amplifier stage with T4, via the full-wave 'detector' with D1 and D2. The output level is sufficiently high for driving most amplifiers.

A short aerial, such as a piece of wire, is enough to provide quite reasonable reception. If a good aerial is to be used, P1 can be inserted to prevent over-driving by too strong a signal.

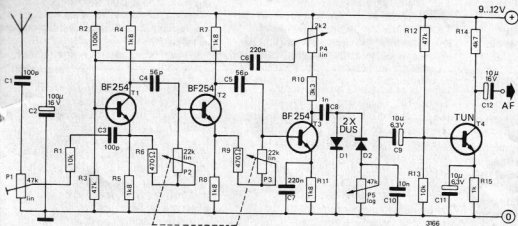

## sensitive coil-less synchrodyne receiver for MW and LW

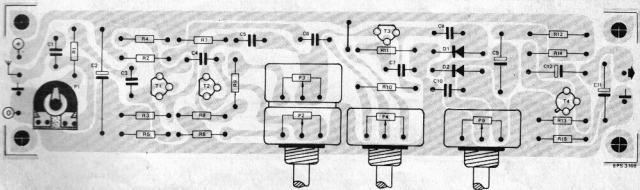
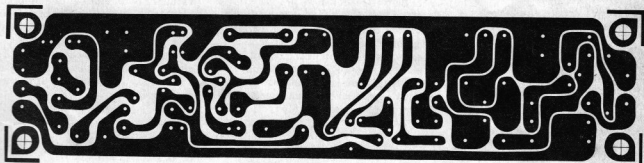

# 23

F.G. Hebinck

Every semiconductor diode has a threshold-voltage, below which there is no useful conduction, so that it cannot rectify small signals. This threshold voltage can however be made very small, with the aid of an op-amp. The op-amp input signal is the difference between the available input voltage ( $V_i$ ) and the output voltage ( $V_o$ ). The diode will conduct whenever this differential voltage, multiplied by the amplifier's open-loop gain, more

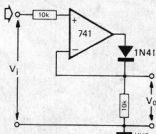

## ideal diode

than equals the diode threshold voltage. The effect at the input of the circuit is a reduction in the apparent diode threshold voltage by a factor equal to the open loop gain of the op-amp. In practice this apparent threshold will be far smaller than the offset voltage of

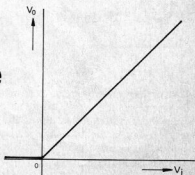

the op-amp, so that it is this offset voltage that determines the apparent threshold. It will usually be a few millivolts. (Lit. Sescosem application note)

## 24

This circuit arrangement will operate as a low-power temperature stabiliser, suitable for 'ovening' quartz crystals.

If the NTC resistor R3 and the transistor T1 (having resistor R4) are mounted together with the crystal on a metal block, the circuit will hold the temperature of the block constant within 0.5°C. A suitable operating point would be in the range 60 ... 70°C; this can be maintained for ambient temperature 0 ... 40°C with or without supply voltage variations within the range 8 ... 16 V.

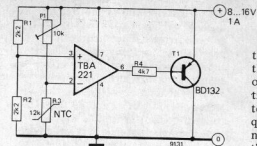

The NTC resistor forms one arm of a Wheatstone bridge (R1, R2, R3 and P1). The unbalance voltage from the bridge is applied to the differential input of the TBA 221 op-amp, which operates as a low-hysteresis voltage comparator. The op-amp quickly saturates in one direc-

## mini-oven

tion or the other, so that the current through T1 is effectively turned on or off. It is the heat dissipation of this transistor which maintains the block temperature above ambient (as required). For optimum performance it is necessary to mount the transistor and the NTC as close as possible to each other.

The values of R1, R2, R3 and P1 have been so chosen that the bridge arms have roughly equal resistance values at the typical operating temperature-range of 60 ... 70°C.

(Mullard)

## 25

This selective amplifier can be continuously tuned, by means of R1a and R1b (stereo-gang potentiometer), from 100 kHz to 2 MHz. The same relative tuning range, about a lower frequency, can be obtained by increasing the values of all the capacitors.

The circuit contains two phase-shifters and an amplifying stage. The first of these phase-shifters is built up around T1, using C1 and R1a. The voltage gain of this stage approaches the ratio  $R_c/R_e$ , which is unity, so that the signal is almost unattenuated. The phase shift varies slowly from 0° to 180° as the frequency is increased, equalling 90° at a frequency determined by C1 and the setting of R1a.

The second phase shifter, built up with T2, C2 and R1b, is identical to the first. The amplifying stage, with T3, produces a phase reversal, i.e. a further 180°. At the critical frequency set by R1a+b the total phase shift going around the feedback loop will be 360°, which means: positive feedback ('reaction'). R2 sets the amount of this feedback. If the total gain inside the loop exceeds unity the circuit will oscillate. When the gain is just marginally below unity the circuit

behaves as a high-Q tuned circuit.

To use the design as a selective amplifier the 'tuning' control R1 (stereo potentiometer) is set to give the required frequency. As the feedback control R2 is now advanced from zero the circuit will become increasingly selective with respect to the frequency of the input signal at A-B. As the oscillation threshold is approached, where the highest Q values are obtained, it may be necessary to set R1 more precisely. If oscillations once start it will be necessary to back off R2 some distance (log potentiometer!) and try again. A second application of the circuit is as synchronised oscillator. The tuning range in this case is the same as for the selective amplifier (and can once again be lowered by using suitably increased

C-values), only now the feedback control is advanced to obtain oscillation and then slightly backed off so that this oscillation is only just maintained.

If a signal very close in frequency to the circuit oscillations is now applied to the input, the oscillator will be pulled into synchronism. The beating that occurs just before 'sync' is achieved can be observed at T3 collector.

It is also possible to synchronise the oscillator to an input at one of its subharmonics. Once again the trick is to set R2 for barely-maintained oscillations, then use an input signal just strong enough to secure synchronisation. The circuit will latch without difficulty onto a frequency 1/20th of that of its own oscillation.

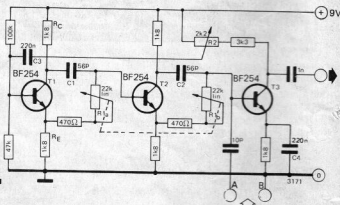

## selective amplifier

## 26

H. Benzel

Those who may find it fun, or even useful in some respect, can easily extend the single lamp stereo indication of an FM-receiver to give an automatic stereo-mono indication. Experiments with the well-known IC stereo decoder MC1310P resulted in the circuit given here. The green LED (D1) is the normal stereo indication; lighting up of the red LED (D3) means that we are listening to a mono broadcast.

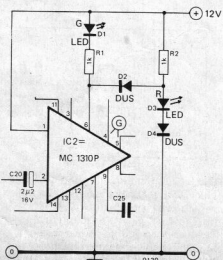

During mono broadcasts, the red LED is connected direct to the supply voltage via load resistor R2 (and diode D4 in series). However, as soon as the IC switches on D1, signifying a stereo broadcast, the voltage across D2 will be considerably less than the drop across D3/D4, with the result that LED D3 will extinguish.

## mono-stereo indicator



29

W. Hollevoet

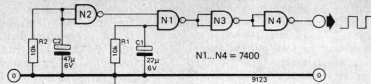

When the supply voltage is switched off, TTL counters and memories lose their information. To prevent them from assuming a random position when the supply voltage is switched on again, we can use the circuit described in this article for a complete automatic resetting or presetting to a certain position. The auto reset circuit functions as follows:

When the supply voltage is switched on, the output of N1 will become logic '1', because capacitor C1 is not yet charged.

Since C2 will not be charged either, the output of N2 will also be logic '1'. The time constants are chosen so that the charging time of C1 is shorter than that of C2. This means that at a certain moment C1 is sufficiently charged for both inputs of N1 to be logic '1', so that the output will be '0'. A short time later, when C2 has charged sufficiently, the output of N2 will become logic '0', with the result that the output of N1 will immediately return to logic '1'. From then on the

## automatic reset for TTL circuits

circuit is stable.

The resistors R1 and R2 serve to discharge the electrolytic capacitors C1 and C2 when the supply voltage cuts out. The moment of switching, and also the pulse duration, can be modified by experimenting with the values of the two resistors and capacitors; the charging time of C1 must, however, always be shorter than that of C2! The values given here will be suitable in most cases.

30

H. v. Hooydonk

Those who have access to an oscilloscope can use this simple accessory-circuit to display several of the characteristic curves of diodes and transistors. The table lists the possibilities.

Switch S2 serves to set the value of the base-current. In the position drawn this bias current can be varied from 0 ... 100  $\mu$ A by means of the 1 M potentiometer; in the other position this bias is non-adjustable and is

modulated - according to the instantaneous value of the incoming supply - between 10 and 100  $\mu$ A (at 6 V supply). The circuit is only suitable for use with low-power devices.

## curve tracer

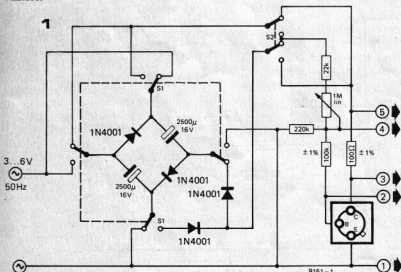

A normal bell-transformer can be used for the power supply to the circuit. The voltage delivered by this transformer (which is invariably higher than the on-load value marked on the housing!) may vary between 3 and 6 volts. At 6 volts the highest DC level in the circuit is about 15 volts.

With switch S1 in the position drawn the circuit is correctly poled for testing PNP transistors; the other switch position reverses all polarities, for testing NPN devices.

### Table

Function	X-input to:	Point M to:	Y-input to	Remark	curve
$I_c = f(I_b)$	4	1	3	S2 in position 1	A
$I_c = f(V_{ce})$	1	3	5	S2 in position 2	B
$I_b = f(V_{be})$	4(1)	2	1(4)	S2 in position 1	C
$I_d = f(V_d)$	1(4)	2	4(1)	S2 in position 1	C

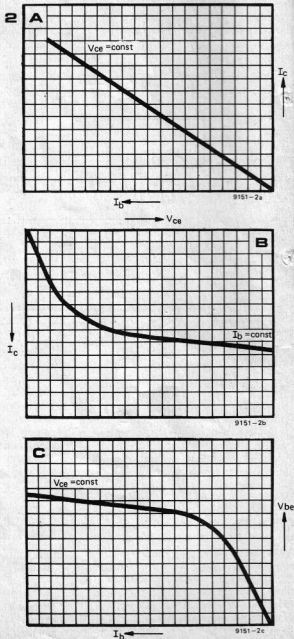



31

M. Mergel

The electronic siren described here is easy and cheap to build.

The circuit consists of two astable multivibrators, N1/N2 and N3/N4. The 0.2 Hz square-wave signal from the latter oscillator is integrated by R3 and

## 7400-siren

C3; this voltage swings the frequency of the other AMV (N1/N2) up and down at 0.2 Hz.

The output level is about 2 V<sub>p-p</sub>, sufficient to drive a power amplifier directly.

### Parts list

#### Resistors:

R1, R2 = 4k7  
R3 = 10 k  
R4 = preset potentiometer 4k7  
R5 = 5k6  
R6 = 1 k

#### Capacitors:

C1, C2 = 1000 μ/6 V  
C3 = 500 μ/6 V  
C4, C5 = 470 n  
C6 = 150 n

#### Semiconductor:

N1...N4 = 7400

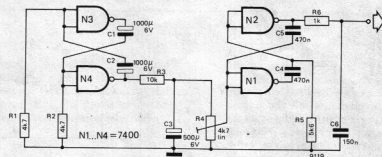
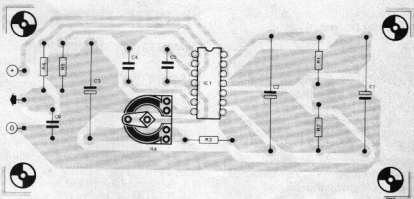
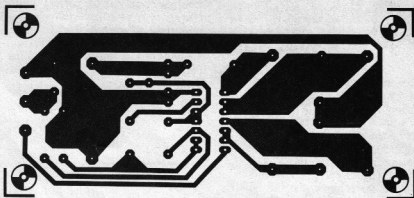

32

B. Krone

Many TTL circuits have relatively low noise immunity and consequently suffer from spurious pulses upsetting the logic process.

This interference can be greatly reduced by using a circuit that recognises logic pulses by their pre-determined length and level.

Some type of RC network (figure 1) could be used for this purpose. It would, however, affect the TTL levels, narrowing the margin for the R and C values.

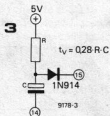
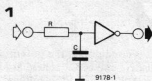

$$t_v = 0.28 R \cdot C$$

A better performance is given by the circuit of figure 2. It compares the duration of the incoming signal with the length of the 'set' state of a monostable multivibrator. The incoming pulse will have effect only when its length outlasts this state. Shorter pulses will not only be rejected but also, at their trailing edges, 'reset' the MMV to prepare it for the next pulse recognition.

Components shown in figure 3 determine the delay characteristic of the circuit (connected to pins 14 and 15). Figure 4 shows the logic pulse diagram. The MMV is 'reset' by a logic '0' whereas a logic '1' of pre-determined length is admitted.

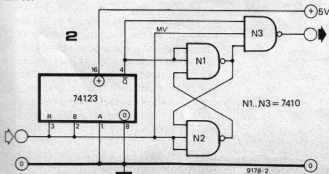

## interference rejector

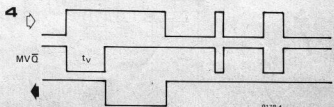

## 33

H. Emmerl

For frequent commercial or holiday drivers by car in W-Germany it is interesting to know that a number of West German FM radio stations transmit, from time to time, useful traffic information. The transmitters in question also carry a continuous 57 kHz pilot tone, enabling a pilot tone indicator in the car to show that the car set has been tuned to the traffic news transmitter.

Readers will, no doubt, recognise the stereo decoder integrated circuit MC 1310 P (SN 76115) put to a somewhat unorthodox use. Due to the fact that the frequency of the traffic news pilot tone differs from that of the stereo pilot tone, the PLL oscillator used for stereo decoding must be adapted. The diagram shows the components R1, P1 and C1 values that determine the VCO frequency.

R2 controls the circuit sensitivity, C4 (which should preferably be a tantalum type) gives a slight switch-on and switch-off delay.

Control P1 adjusts the correct oscillator frequency to 57 kHz: as soon as the pilot tone is detected, the LED will light. The LED series resistor R4 depends on the type of LED and the car battery voltage and can be calculated from the equation

$$R_4 = \frac{V_b - 2}{I_{LED}}$$

## traffic news service tuning indicator

For a 12 V battery voltage and 20 milliamps LED current this gives R4 = 500 ohms; the nearest standard value (470  $\Omega$ ) can be used. It is recommended to incorporate the circuit in the car set itself. The

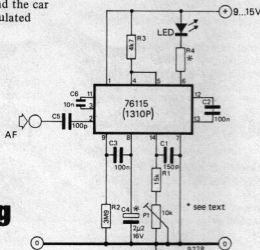

de-emphasising network in the detector output circuit must be removed; it would impair the 57 kHz pilot signal. The treble boost caused by the removal can easily be compensated for in the car set audio amplifier.

## 34

F.H. Burmester

It is often necessary to provide a negative supply in circuits where the main supply voltage is positive. For instance, stabilised power supplies may require a negative reference voltage, so that outputs close to zero volts may be obtained, or it may be necessary to use operational amplifiers requiring + and - supplies in logic systems having a single positive supply rail. For these applications a second transformer winding is an expense that can be avoided using this simple circuit.

The circuit operates on a voltage doubler type of principle. The positive supply is obtained from a conventional bridge rectifier. On the positive half-cycle (with respect to the end of the transformer winding marked with a dot) C1 charges through D1 and D2. C2 charges through D5. During the negative half-cycle C1 charges through D3 and D4.

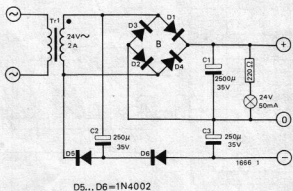

Whilst D3 is conducting, the potential on the positive end of C2 is held at just below zero volts (due to the voltage drop across D3). This means that the negative end of C2 is at minus the supply voltage. C3 therefore charges from the voltage across the transformer secondary and C2 through D4, D6 and C1. To ensure that (almost) equal voltages appear across C1 and C3, D3 must remain in conduction.

## +/- from one winding

This means that the current drawn by the positive supply must be greater than that drawn by the negative supply, so that the difference current will flow back along the zero volt rail, through D3. If the positive and negative supply currents are equal then an indicator lamp may be connected across the positive supply to produce an imbalance. This will also serve as a mains indicator.

## 35

E. Dickopp

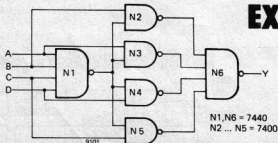

The circuit described here is a four input 'exclusive or' gate. When all inputs are logic '1', the output

of N1 is logic '0'. One input of each of the following gates is now driven to logic '0' from N1 and the other input

## EX-OR

of each gate is driven to logic '1' by the inputs. The outputs of N2, N3, N4 and N5, and thus also the inputs of N6 are now high, so that output Y is logic '0'. Similarly, when the inputs are all logic '0' output Y will be '0'. If only one of the input signals is low, say B, the output of N1 (and with it the common inputs of the following gates) becomes logic '1'. The outputs of gates N3, N4 and N5 now all produce a '0', so that Y becomes logic '1'. For all other combinations (14 in total) the output will always be logic '1'.

36

J. Tabel

2



During recording on tape, it is necessary to ensure that the signal voltage at some point does not exceed a predetermined level. A similar situation can occur with (pre-)amplifiers and measuring instruments.

In such cases a meter-type indication is not the only possibility - and indeed it is invariably not the best. An overmodulation indicator that lights a lamp is cheaper - and gives a more distinct warning. The accompanying circuit is designed for this purpose.

Transistor T1 is an emitter follower, providing a high input impedance (about 100 k $\Omega$ ) to minimize the load on the signal source. The trimmer R3 sets the voltage at which the lamp will just light up (overmodulation level). The circuit around T2 is a  $\times 100$  ampli-

fier which enables the threshold to be set as low as 5 mV. When this high sensitivity is not needed, i.e. when the threshold is 0.5 volt or higher, the stage can be omitted. The points A and B are then bridged. If the high input impedance is also unnecessary, as for instance when a loudspeaker-connection is being monitored, it is obviously permissible to omit the input stage also. Figure 2 shows how the input is made to point B in this case.

The circuit following point B is the indicator proper. The current through R6 normally 'bottoms' T3, so that T4 is cut off. Alternating signal voltage at point B however, rectified by the action of D1, D2, C3 and C4, will cause a negative drive to be applied to T3 base. When this AC voltage exceeds about

## overmodulation indicator

0.5 volts, T3 will no longer be bottomed, so that T4 will start to conduct. 'Monoflop' action via C4 will now ensure that even short signal peaks are clearly indicated by the lamp. When selecting the type of lamp, one should note that the maximum available current is about 100 mA. With a supply voltage of 7 V as shown, the lamp should be a 6 ... 7 volt type. If circumstances dictate, a resistor can be inserted in series with the lamp. Given the supply voltage ( $V_B$ ), the lamp voltage ( $V_L$ ) and the lamp current ( $I_L$ ) in amps, the series resistor (R) value required is:

$$R = \frac{V_B - V_L}{I_L}$$

To take an example, suppose that a 6 volt 50 mA (= 0.05 A) lamp is to be used on a 9 volt supply:

$$R = \frac{9 - 6}{0.05} = 60 \Omega,$$

for which the nearest lower standard value of 56  $\Omega$  would be taken.

37

G. Tajbl

This circuit uses a start/stop oscillator and a monostable multivibrator. The monostable is triggered by the trailing edge of the pulse to be multiplied (see pulse train 1 in the diagram). This sets the Schmitt trigger S1 oscillating (2) for a period that can be set by P1. P2 controls the oscillator frequency. In this way, one single incoming pulse generates a well-defined number of outgoing pulses. A further Schmitt trigger S2 is used as a buffer stage and produces the pulse train shown at (3) in the diagram.

P1 must be adjusted to a value permitting the highest number of incoming pulses to be passed on correctly. If the

monostable period is too long, the 74122 will act as an unwanted frequency divider. After P1 is set to the correct value, P2 is used to set the desired multiplication coefficient.

The pulse multiplier will find a number of different applications. It will, for instance, permit a low frequency such as heart beats to be counted with reasonable accuracy.

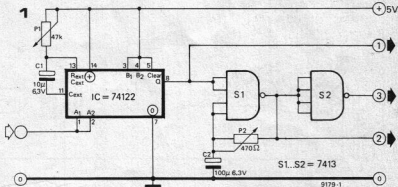

## pulse multiplier

2

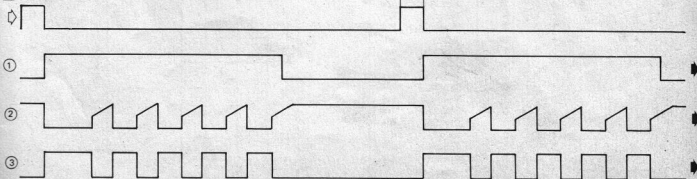

## 38

Electronics is beginning to establish a firm foothold even in the world of music, as is evident from the introduction by SGS-Ates of two 'rhythm generator' ICs.

The simplest of these ICs is the M 252, which can be obtained in a number of different versions. In addition to an IC with standard programming, ICs with rhythm patterns tailored to the customer's requirements can also be supplied.

The M 252 B1 AA or D1 AA has fifteen

## integrated rhythm generator M 252

standard rhythms and facilities for driving eight generators ('instruments'). With this IC, the choice of rhythm is determined by four programmable binary inputs, as shown in the block diagram. This makes it possible to have a rhythm generator of very simple design, because four single-pole programming switches, operated as shown in Table 1, are all that is needed for selecting the rhythms.

As the circuit given in figure 3 shows, only a few additional components are

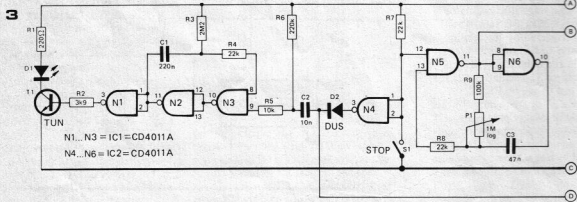
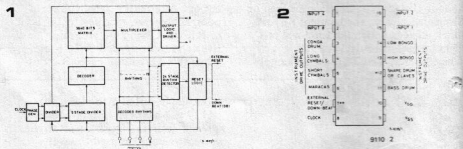
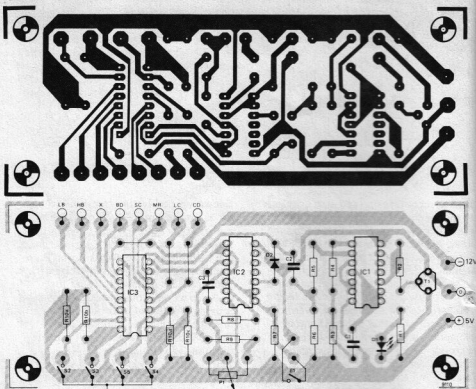

N1...N3 = IC1 = CD4011A

N4...N6 = IC2 = CD4011A

CODE				RHYTHM	
INPUT 8	INPUT 4	INPUT 2	INPUT 1		
1	1	1	0	Waltz	3/4
1	1	0	1	Jazz Waltz	3/4
1	1	0	0	Tango	2/4
1	0	1	1	March	2/4
1	0	1	0	Swing	4/4
1	0	0	1	Foxtrot	4/4
1	0	0	0	Slow Rock	6/8
0	1	1	1	Rock Pop	4/4
0	1	1	0	Shuffle	2/4
0	1	0	1	Mambo	4/4
0	1	0	0	Beguine	4/4
0	0	1	1	Cha Cha	4/4
0	0	1	0	Bajon	4/4
0	0	0	1	Samba	4/4
0	0	0	0	Bossa Nova	4/4
1	1	1	1	No selected rhythm	

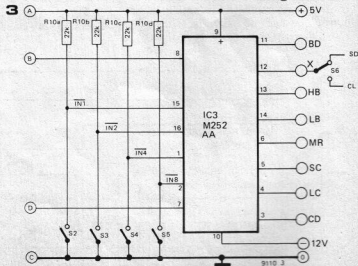

needed for a complete rhythm generator. Each of the outputs of the M 252 can be connected to an appropriate electronic percussion instrument, the output at pin 12 is used for both the snaredrum and the claves. The snaredrum is generally used with rhythms 1 to 9 inclusive and the claves with rhythms 10 to 15 inclusive (the South American rhythms). This interlinking does not occur automatically, so either the claves or the snaredrum can be used with any rhythm.

# 39

The M 253 exhibits a number of basic differences in comparison with the M 252. In the first place the chip is simpler, as the binary programming facility has been omitted. Secondly, only twelve standard rhythms are available with this IC. As the block diagram (figure 1) shows, the mode of operation is in other respects practically the same as the M 252.

As a result of the omission of binary inputs, each rhythm must be selected with a separate switch. In some ways this is a disadvantage, but on the other hand it opens up the possibility of making up a greater number of rhythms. As each rhythm must be selected with a separate switch, a 16-pin package is not enough, so a 24-pin dual-in-line package is used to accommodate the chip. The design of the oscillator and the down-beat indicator is the same as for the M 252 circuit.

Pin connection data for this IC are given in figure 2, and the complete circuit is shown in figure 3. It should be noted that, as with the M 252, a single output serves for both snare drum and claves. For the South American rhythms, the claves are used in place of the snare drums. The one exception to this is the tango.

SGS-ATES appl.)

Besides the programmed inputs, the IC has also a reset input with which the rhythm pattern can be interrupted. This input also serves as an output for the so-called 'down beat' indication, because the internal reset signal is routed via the reset input to an output connection. By adding the isolating diode D2, the reset connection can be used as both an input and an output. In this way it is possible to give an optical indication of the beginning of each beat directly from the reset pulse. The reset pulse (5  $\mu$ s

width) is lengthened by a monostable multivibrator in order to obtain a clear indication.

The stop-switch (S1) provides for resetting the IC and at the same time blocks the tempo oscillator.

Figure 4 shows the p.c.board and the component layout for this circuit.

(SGS-ATES appl.)

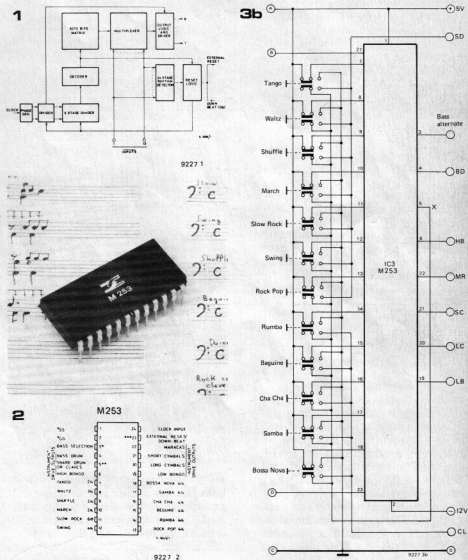

## integrated rhythm generator M 253

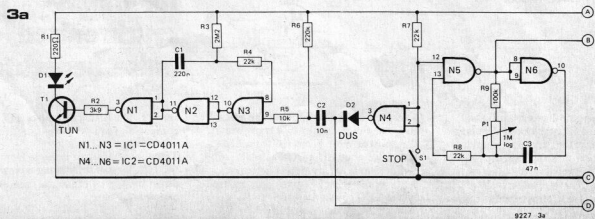



**Resistors:**

- R1 = 2M7
- R2 = 4M7
- R3, R4, R5, R12 = 1 k
- R6, R9, R13 = 4k7
- R7 = 39 k
- R8 = 5k6
- R10 = 47 k
- R11 = 220 k
- R14 = 100 k

**Capacitors:**

- C1 = 1  $\mu$ , 6 V tantalum
- C2 = 470  $\mu$ , 6 V electrolytic
- C3 = 100  $\mu$ , 16 V
- C4 = 100  $\mu$ , 25 V
- C5, C6 = 2n2
- C7 = 39 n
- C8, C9, C12 = 25  $\mu$ , 16 V
- C10 = 1 n
- C11 = 50  $\mu$ , 6 V

**Sundries:**

- P1 = preset potentiometer  
1 k lin.
- P2 = potentiometer  
4k7 log. stereo
- P3, P4 = potentiometer  
100 k lin. stereo
- P5 = potentiometer 10 k lin.

**Semiconductors:**

- T1, T3 = TUN
- T2 = TUP

## astereo control amplifier

Transistors T1 and T2 form a voltage amplifier with a high input impedance and a low output impedance. When the slider of preset potentiometer P1 is set to give the full value of 1 k, the input sensitivity in combination with the 3-watt amplifier is about 150 mV for the 12-volt version working into a 4- $\Omega$  load, or 200 mV for the 17-volt version working into an 8- $\Omega$  load.

If a higher input sensitivity is required,

P1 can be set to a value lower than 1 k. If switching to different values of input sensitivity is needed, fixed resistors can be used in place of P1, with values determined according to the formula:

$$R_x = \frac{500 \times V_{in}}{300 - V_{in}} \text{ (ohms)}$$

where  $V_{in}$  is the RMS input voltage in mV. The formula holds good for input voltages from 5 mV to 250 mV. T3 is used in a standard Baxandall tone control circuit. The 1 nF capacitor between the collector and earth is to prevent oscillation.

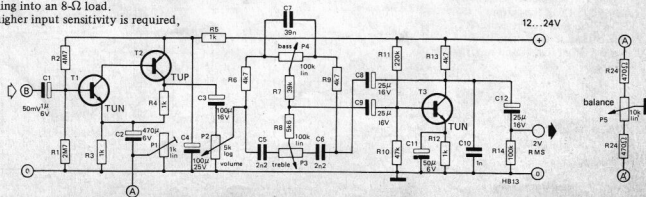
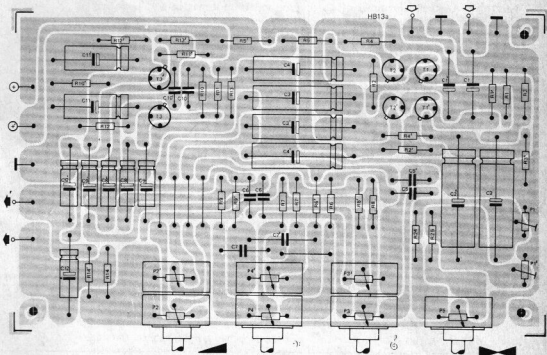
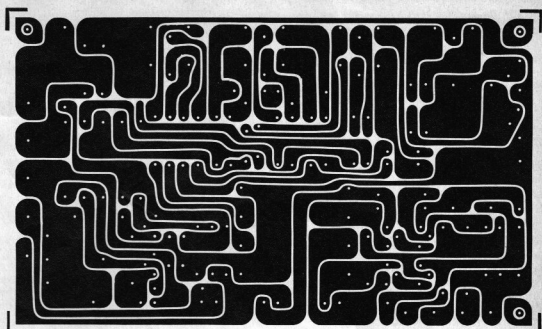

## 45

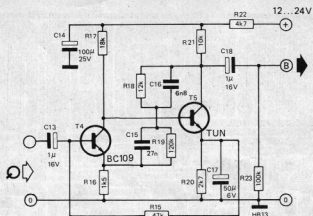

The disc preamplifier, of which only one channel is shown in the circuit, incorporates equalisation to correct the output of a magnetic cartridge according to the RIAA playback curve, and also amplifies the signal to a level sufficient to drive the control amplifier. It consists of a two-stage voltage amplifier, T4 and T5, with the RIAA feedback network R18, R19, C15 and C16 connected from the collector of T5 to the emitter of T4. DC feedback and biasing of T4 is

provided by R15. The disc preamplifier board should preferably be mounted inside the turntable box as otherwise the capacitance of the screened lead between the cartridge and the disc preamplifier can form a resonant circuit with the self-inductance of the cartridge. If this resonance lies within the audio spectrum it may cause a peak in the frequency response. Of course some cartridge manufacturers quote a recommended load capacitance and if this

## austereo disc preamplifier

is so their recommendations should be adhered to. Another good reason for mounting the disc preamplifier inside the turntable is to keep it away from the hum fields of the amplifier's mains transformer. Turntable motors usually have much less stray field than the average mains transformer! It can be seen that the layout for the two channels is symmetrical.

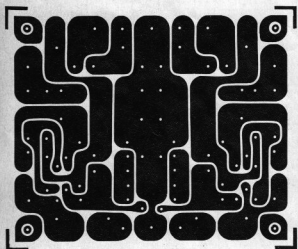

## Resistors:

R15 = 47 k  
R16 = 1k5  
R17 = 18 k  
R18 = 12 k  
R19 = 120 k  
R20 = 2k7  
R21 = 10 k  
R22 = 4k7  
R23 = 100 k

## Capacitors:

C13, C18 = 1 µ (16 V)  
C14 = 100 µ/25 V  
C15 = 27 n  
C16 = 6n8  
C17 = 47 ... 50 µ/6 V

## Semiconductors:

T4 = BC 109 C  
T5 = TUN

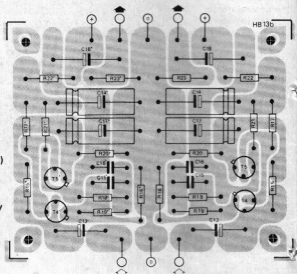

## 46

Transistors T1 and T2 form a direct-coupled voltage amplifier. Resistor R6 and diodes D1/D2 determine the quiescent current of the quasi-complementary driver stage T3/T4 and the output stage T5/T6. The values of resistors R7 and R8 are chosen so that the output transistors are either just biased on or

## austereo 3-watt hifi amplifier

## Resistors:

R1, R2 = 100 k  
R3, R5 = 4k7  
R4 = 470 Ω  
R6 = 33 Ω  
R7, R8 = 56 Ω  
R9, R10 = 0,2 Ω  
R11 = 1 k  
R12 = see table

## Capacitors:

C1 = 2,2 µ, 16 V  
C2 = 100 µ, 16 V  
C3 = 10 n  
C4 = see table  
C5, C6 = 47 n

## Semiconductors:

T1, T3 = TUN  
T2, T4 = TUP  
T5, T6 = 2N1613  
D1, D2 = DUS  
heatsinks for T0-5

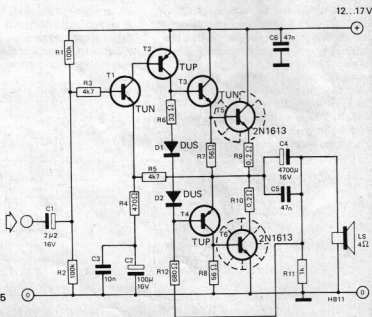



just cut off depending on the gain of the transistors used. C3, C5, C6 and R3 help to maintain stability. The input sensitivity of the amplifier is about 400 mV for 12-volt operation with a 4- $\Omega$  load, and 600 mV for 17-volt operation with an 8- $\Omega$  load. The gain may be increased by reducing R4 but this is not recommended as instability may occur and distortion is increased.

The following layout precautions should be noted when assembling the

	12 V	17 V
R12	680 $\Omega$	1 k
C4	4700 $\mu$	2200 $\mu$
LS	4 $\Omega$	8 $\Omega$

completed board onto a chassis:

1. Loudspeaker common must be connected directly to the power supply common and should be kept well away from the boards.

2. Separate leads must be run from the supply to the supply points on each board.
3. Outputs of any board should be kept well away from inputs of other boards (except of course where the output of a stage is connected to the input of the succeeding stage).
4. Care should be taken to avoid earth loops. Each section of the amplifier should have only one connection to supply common.

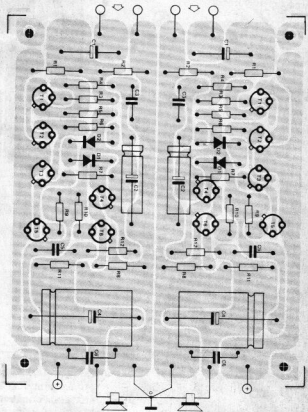
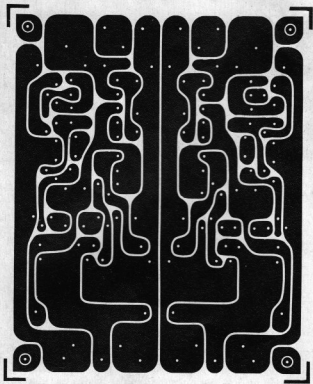

# 47

The mostronome is a metronome which differs from all other types in that it does not produce a 'tap', but a brief whistle. This is pleasant to the ear and at the same time far more penetrating than the sound produced by the conventional 'tap' generators.

The repetition frequency of the mostronome is generated by the gates N1 and

N2. With potentiometer P1 the frequency can be varied between about 40 x per minute and 10 x per second. Point 3 of gate N1 drives transistor T1 which is connected as a buffer stage. Via resistor R4, the emitter voltage of this transistor periodically drives transistor T3 on and off. The gates N3 and N4 form a square wave oscillator with a frequency around 500 Hz. The output of this oscillator (point 11 of gate N4) switches transistor T4 via T2 and R8. T4 does not pass the oscillator signal continuously because the base of this transistor is periodically cut off by T3.

## mostronome

The short whistle (abt. 0,15 s) periodically available at the emitter of T4 arrives at the base of T5 via R9. Via R10 and volume control P2, the collector of T5 drives a loudspeaker.

The impedance of this loudspeaker may lie between 4  $\Omega$  and 16  $\Omega$ .

Since the average current consumption is low because the whistle is very short, a 6 V battery (powerpack) is quite sufficient to serve as the power supply.

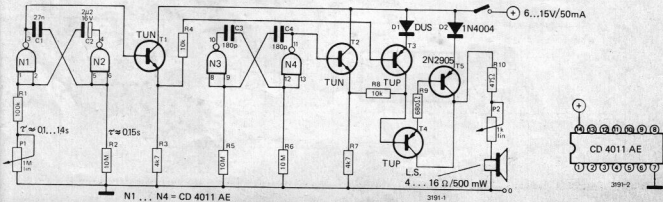

## 48

Transistors T1 and T2 form a Darlington pair acting as a compound emitter-follower with a reference voltage provided by Z1. Z1 is chosen as a 13 or 18 volt zener for a 12 or 17 volt supply respectively. Since T2 dissipates only a small amount of power a heatsink is not required.

## austereo power supply

Resistor:  
R1 = see table

Semiconductors:  
T1 = 2N3055  
T2 = see table

Capacitors:  
C1 = 2200  $\mu$ , 25 V  
C2 = 100  $\mu$ , 25 V

Trafo:  
Tr = 2 A sec., see table

Sundries:  
B = B40C2200  
Z1 = zenerdiode, 250 mW, see table  
N = neon  
S = on/off switch

	12 V	17 V
R1	270 $\Omega$	680 $\Omega$
Z1	13 V	18 V
T2	TUN	BC107
Tr	12 V~	18 V~

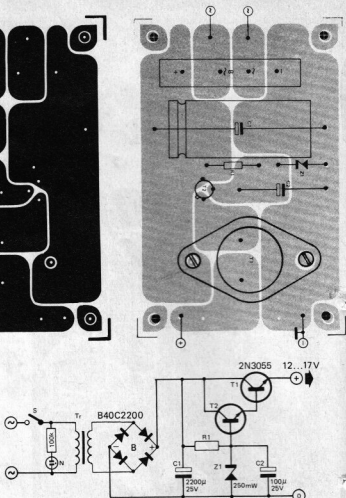

## 49

F. Schaeffer

Many pocket calculators have a constant factor memory. If a 1 is stored in this memory, depressing the  $\frac{1}{x}$  key adds 1 to the number already displayed. If the original number displayed is 0 and the  $\frac{1}{x}$  key is depressed at regular intervals, the number displayed at any given time is equal to the number of times the key has been depressed, which in turn is proportional to time. This means that the calculator can be used as a stopwatch.

Figure 1 shows a practical circuit. It can be built as a separate unit, so that

surgery on the calculator can be reduced to a minimum: all that is needed is an external connection to the contacts of the  $\frac{1}{x}$  key (figure 2).

The stopwatch adapter itself is simply a standard frequency generator that can be switched on and off. The frequency

## calculator doubles as stop- watch

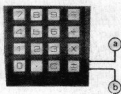

is derived from the 50 Hz mains: the output from the bridge rectifier (100 Hz) is divided by 10. The result: 10 Hz signal is fed to gate N3; depending on the state of the set/reset flip-flop (N1/N2) it can be passed on to the output transistor. This transistor can be used to drive a (reed) relay; the relay contacts are connected in parallel with the  $\frac{1}{x}$  key.

Of course, if enough is known about the calculator circuit the relay can usually be omitted. For instance, if the  $\frac{1}{x}$  key connects a positive voltage to supply common, the relay is omitted, the output transistor can be a TUN, and its collector is connected directly to the positive terminal of the  $\frac{1}{x}$  key. The supply commons are interconnected.

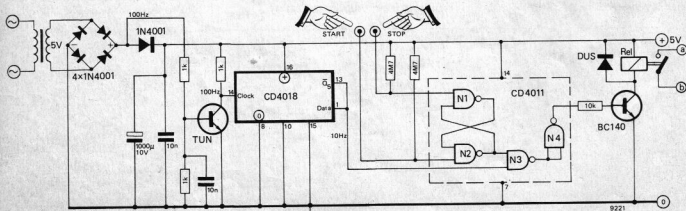

# 50

The 'austereo' 3-watt amplifier is used as a drive amplifier for the 2N3055 output transistors, and very few changes in the circuit or the component values are needed. Capacitor C7 is introduced to compensate for the phase shift due to the output transistors. The value of R1 is reduced to 56 k, and additional decoupling, in the form of a 47-k resistor and a 10- $\mu$  capacitor, is inserted between the high-potential end of R1 and supply positive. The output impedance is very low, as T5/T7 and T6/T8 form power darlings. The 'austereo' control amplifier is well capable of supplying the 1-V RMS input voltage needed.

Because of the low input sensitivity, the amplifier has good stability and its sensitivity to hum is low. Substantial negative feedback via R4 and R5 ensures low distortion.

Maximum permissible supply voltage is 42 V. The power supply circuit is developed from the stabilised power supply unit for the 'austereo' amplifier, with circuit modifications and also changes of component ratings to suit the higher working voltages.

In addition to the heat sinks shown in the amplifier and power supply circuits, the three 2N3055 transistors should be cooled by mounting them on the amplifier or power supply boxes (as applicable) using mica insulating washers.

The power supply table is worked out for stereo. Power for the control amplifier is drawn from a 2N1613 with its base potential held at half the main supply voltage.

		Power output (w) with:			
		8 $\Omega$	4 $\Omega$	2 $\Omega$ (R13, R14 = 0.1 $\Omega$ )	
power supply voltage (V)	30	9.5	19	35	25 C4
	36	15	30	55	25 working
voltage (V)	42	20	40	70	35 voltage (V)
		2200	4700	10,000	
		C4 capacity ( $\mu$ F)			

### Parts list for 15-30 W amplifier

#### Resistors:

- R1 = 56 k
- R1a = 47 k
- R2 = 100 k
- R3, R5 = 4k7
- R6, R9, R10 = 33  $\Omega$
- R7, R8, R11 = 1 k
- R12 = 1k2
- R13, R14 = 0.22  $\Omega$ , 5 W

#### Capacitors:

- C1 = 2.2  $\mu$ , 35 V
- C2 = 100  $\mu$ , 35 V
- C3 = 10 n
- C4 = see table
- C5, C6 = 47 n
- C7 = 100 p
- C8 = 10  $\mu$ , 35 V

#### Semiconductors:

- T1, T3 = BC107
- T2, T4 = BC177
- T5, T6 = 2N1613
- T7, T8 = 2N3055
- D1, D2 = DUS
- 5 heatsinks for TO5

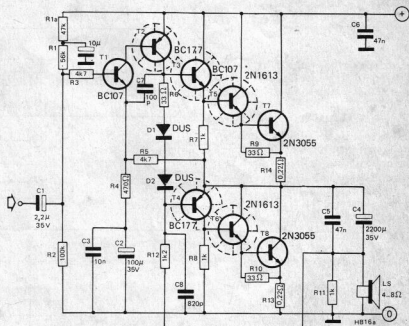

## 'austereo' 15-30 watt amplifier

### Parts list for 15-30 W power supply

#### Resistors:

- R1 = see table
- R2 = 1k8
- R3 = 100  $\Omega$
- R4, R5 = 10 k
- R6 = 100 k

#### Capacitors:

- C1 = see table
- C2 = 47  $\mu$ , 50 V
- C3 = 47  $\mu$ , 25 V
- C4 = 47 n

#### Transformer:

see table

#### Sundries:

- B = Bridge rectifier; see table
- Z = Zener diode, see table
- N = Neon lamp
- S = On/off switch
- Heat sink for TO5

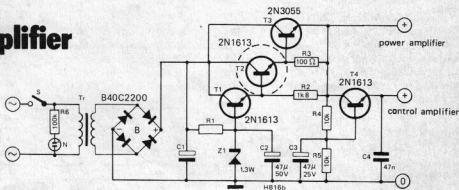

Output power	Transformer secondary		B B40C...	C1 x 100 $\mu$ F	Z	R1 $\Omega$ 1 watt
	V	A				
9.5 - 19 - 35	30	1 - 2 - 4	1000 - 2200 - 5000	22 - 47 - 100 50 V	ZD 33	680
15 - 30 - 55	36	1.2 - 2.4 - 4.8	2200 - 3200 - 5000	22 - 47 - 100 60 V	ZD 39	820
20 - 40 - 70	42	1.2 - 2.5 - 5	2200 - 3200 - 5000	22 - 47 - 100 70 V	ZD 43	1 k



## 53

P. Rampelbergh

When testing continuity by means of an ohmmeter, there is always the danger that resistors, semi-conductors etc. are involved in the measurement, giving false readings. Furthermore the current or voltage of the meter can sometimes damage the circuit.

With the design described in this article, these disadvantages are avoided; the tester does not 'see' a resistance greater than 1 ohm as a connection.

The measuring voltage is no more than 2 mV, so that no diode, IC or any other element is included in the measurement.

The maximum measuring current into the circuit under test is 200  $\mu$ A.

The indication is by way of a LED; if it is fitted in one of the two measuring probes, the tester becomes quite a handy instrument. The supply can be via two 9 V power packs.

The voltage offset of the IC can be compensated by means of potentiometer P1 (which can compensate about 8 mV). For adjustment, the measuring points are short-circuited and P1 is adjusted so that the LED just lights. When the measuring points are opened again, the LED goes out.

A printed circuit board was designed for this very inexpensive and yet extremely handy measuring instrument.

By virtue of its modest dimensions (18 x 68 mm) it can be fitted in practically any suitable housing.

## Parts list.

## resistors:

- R1, R3 = 22 k  
R2 = 10  $\Omega$   
R4, R5 = 1 k  
R6 = 470 k  
R7 = 470  $\Omega$   
P1 = preset potentiometer  
10 k lin

## semiconductors:

- IC = 709  
D1 = DUS  
D2 = LED

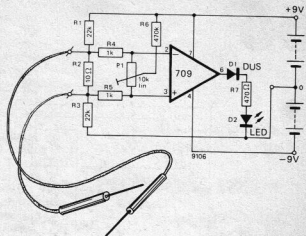

## p.c. board and wiring tester

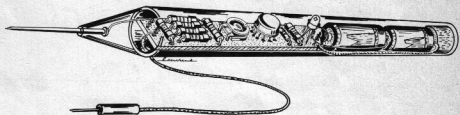
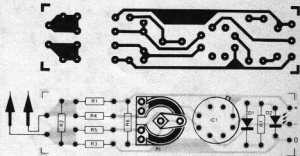

## 54

## hum receiver

The hum receiver consists of one COS/MOS IC comprising four NAND-gates (CD 4011). The four gates are series-connected as amplifier elements. The first gate (N1) picks up the hum radiated by the mains. The inputs of this gate should not be in the close vicinity of other sources of interference (amplifier outputs, etc.). A copper wire 2 to 3 cm long is sufficient

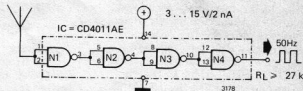

to pick up the hum and to produce a square wave with a frequency of 50 Hz and a risetime of about 20 ns at the output of gate N4. Depending on the conditions, one or more gates can

sometimes be omitted.

The current consumption of the entire CD 4011 is so low that if a 4.5 V battery is used as the power supply, its life will be essentially shelf life.

## 55

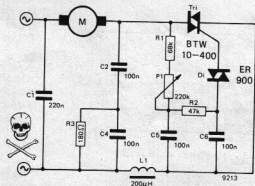

This circuit is intended for continuous speed control of small series wound motors, as used in most electric hand

drills, etc.

The speed is adjusted by potentiometer P1. The setting of this potentiometer

determines the moment at which the triac is triggered. If the motor speed drops below the preset value (under load), the back EMF of the motor reduces. Consequently, the voltage

## triac speed controller

across R1, P1 and C5 increases so that the triac is triggered sooner, and the motor speed will be increased. In this way, a certain amount of speed stabilisation is obtained.

(Transtron)



59

R.L. Rappenecker

The supply voltage for a relay is chosen so that the relay will pull-in reliably. The holding voltage is, however, much lower: often even less than half the pull-in voltage. Consequently most relays function satisfactorily at a reduced voltage provided it is ensured that at the moment of activation the voltage is increased sufficiently. The circuit given here is suitable for relays drawing up to 100 mA, whilst the supply voltage must be lower than 25 V. Using this circuit has two advantages: firstly the relay draws considerably less current; at half the supply voltage the

power consumption has already been reduced to one quarter! Secondly, a given relay can be used at voltages which so far were too low to ensure reliable functioning. (For example a 6 V relay that must function on the 5 V from a TTL supply). The circuit is connected to a supply voltage which is certain to hold the relay. As long as S1 is open, C1 is charged via R2 to the supply voltage. R1 is connected to the + terminal and T1 will not conduct. As soon as S1 is closed, the base of T1 is connected to supply common via R1, so that it conducts and drives the relay. Via S1 the positive terminal of C1 is connected to supply common, and since this capacitor was charged to the supply voltage its — terminal is now at a negative potential. The voltage across the coil of the relay is now equal to double

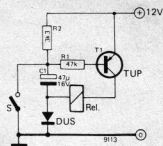

## economic relay

the supply voltage, and the relay will pull in. Switch S1 can, of course, be replaced by a transistor (TUP or TUN) which is then switched on or off.

60

Since the price of a universal meter is usually more than proportional to its 'ohms-per-volt', it is useful to have an adapter which makes the input impedance sufficiently great to measure high-impedance circuits, such as pre-amplifiers and MOS circuits. The adapter shown here can be used with meters having an impedance exceeding about 2 k $\Omega$ /V. The circuit consists of a source follower with an input impedance of about 10 Mohm where the pinch-off voltage is used to obtain a zero setting for the instrument. The voltage at T1 source is higher than the artificial zero (via R3 and R4) and the voltage at T2 drain is below the zero, provided sufficient current flows

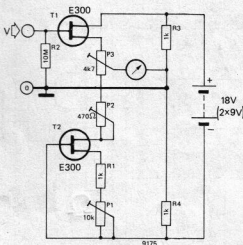

through T1 and T2. The choice was in favour of a FET current source because of its very low temperature coefficient. P1 is used to set the current through T1

## FET $\Omega$ adapter

and T2 to about 1 mA (4.7 V across P3). Next, P3 is used for a coarse zero adjustment, and finally P2 is used for fine adjustment of the zero setting of the meter. The values of P1, R1, P2 and P3 apply for a meter with a sensitivity better than 10 k $\Omega$ /V. When using a less sensitive instrument, the current through the FETs should be increased accordingly and the values of the above-mentioned components reduced. The supply can be two series-connected 9 V batteries, or one 18 V mains supply which need not be stabilised. The maximum permissible supply voltage is 30 V. At 18 V the current consumption is 10 mA, the maximum input voltage is then  $\pm 6$  V. If higher voltages must be measured, an input attenuator is needed.

61

The frequency meter is suitable for any sinusoidal or pulse input signal. The minimum input voltage amplitude at which the circuit still functions satisfac-

torily is 25 mV r.m.s. The measuring range of the circuit is from 10 Hz to 100 kHz depending on the setting of switch S1. Each setting is calibrated with a 20 k potentiometer. The total current consumption is about 10 mA. The values of R1 and C1 are selected according to the type of micro- or millimeter. The table gives the

meter at  
f.s.d.

	R1	C1
100 $\mu$ A	39 k	2 $\mu$ , 10 V
500 $\mu$ A	6k8	15 $\mu$ , 10 V
1 mA	3k9	25 $\mu$ , 10 V

various values of R1 and C1 for meters with different values of full-scale deflection.

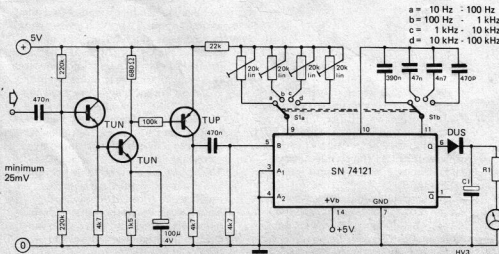

## analogue frequency meter (rev. counter)

## 62

H. Stell

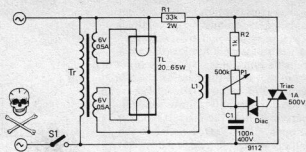

The luminous intensity of fluorescent lamps cannot be controlled by means of conventional light dimmers, unless certain modifications are carried out. In the circuit described here the heaters of the fluorescent lamp are pre-heated by means of a heater transformer with two separate windings. The starter is

omitted, while the choke (L1) can remain in the circuit. The (conventional) triac control is connected via the choke with a 33 k/2 W 'bleed' resistor across the tube and choke to supply current to the dimmer whilst the tube is extinguished. Alternatively, three resistors of 100 k/

## fluorescent lamp dimmer

½ W can be connected in parallel. Any suppression networks originally in the triac dimmer should be removed; the large self-inductance of L1 will limit the interference caused by the dimmer to a minimum. If the range of control is considered insufficient, it is possible to experiment with the value of capacitor C1.

Standard precautions should, of course, be taken: the circuit must be mounted in an insulating box, P1 should have a plastic spindle, and C1 must be a 400 V type.

## 63

W. Heinrich

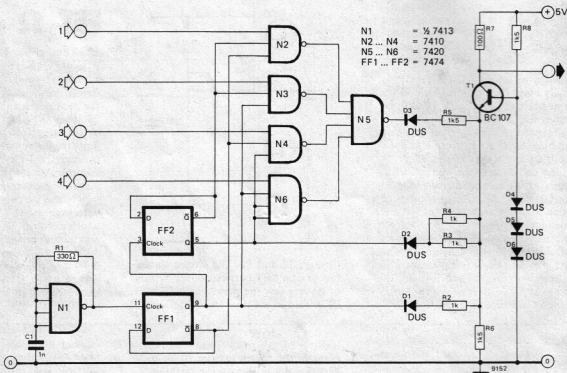

This four-channel switch is an excellent aid when comparing digital signals with an oscilloscope. In the version described here the switch works as a chopper. With a small addition it can also work in 'alternate' mode. The chopper frequency is generated by a Schmitt trigger (N1) connected as an oscillator. With the given component values the oscillator frequency is about 2.5 MHz. This means that the chopper cycle frequency will be around 600 kHz, for the four-channel version described here.

The oscillator signal is fed to a divide-by-four counter, from which the channel selection signals are derived. These signals are used to drive the gates N2, N3, N4 and N6 sequentially. The signal from the selected gate is fed to the emitter of T1 via N5. This transistor works as a current source, where the current is determined by the state of the divide-by-four counter and the input signal level. The current gives a voltage

## digital four-channel switch

drop across R7, which in turn determines the position of the trace on the oscilloscope tube. With no input signal on the four inputs four horizontal lines are displayed. The position of each line is determined by the setting of the current source, which in turn is determined by R2 to R6. With the given component values the DC level of the output voltage is about 4.6 V. The logic signals have an amplitude of about 50 mV.

With some oscilloscopes the range of the

vertical position control will be insufficient to bring all the signals onto the screen. In this case resistor R7 can be replaced by a preset potentiometer of 470 Ω, so that the 70 mV now available per channel can be expanded to a maximum of about 250 mV. However, this in turn leads to a reduced switching speed of the circuit. T1 should certainly never be driven into saturation, because this would have a very unfavourable effect on both the switching time and display of the signals.

When digital signals of a very high frequency must be compared, the oscillator frequency must be reduced by increasing C1 to 10 n or even 100 n. The signals are then no longer chopped, but displayed sequentially on the oscilloscope tube ('alternate mode'). To maintain the proper phase relation, one of the signals must be used as an external triggering source for the oscilloscope.



# 64

B. Uschner

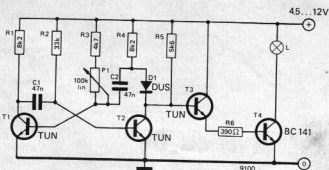

## economic flashlight

Since the full brightness of a torch is only rarely needed, a suitable dimmer will be a welcome energy saver.

The system is designed around an astable multivibrator whose duty-cycle can be varied by means of potentiometer P1. The diode has been added to improve the rise time. Via T3 the

AMV switches transistor T4, which in turn switches the lamp. T4 requires no extra cooling.

The control range is such that the lamp can be adjusted to burn at about one-third of its normal light intensity; this means that the batteries will then last three times as long.

The application of the circuit is, of course, not limited to torches; it can also be used for panel lights, radio scale illumination, etc. If P1 is replaced by an LDR, it is also possible to obtain an automatic dimmer that adapts the brightness of the lamp according to the ambient light conditions.

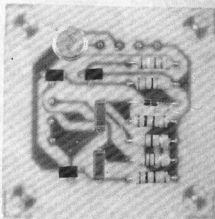
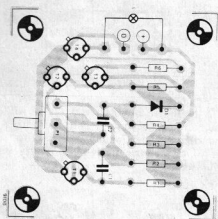
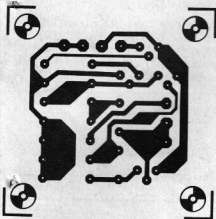

# 65

The frequency response of the human ear is limited. The purpose of the ultrasonic detector is to overcome this limitation by changing the frequency of high-pitched sounds such as dog whistles, hardly perceptible gas leaks, bat's bleeps, and various man-made

ultrasonic noises such as softly fingering a newspaper (which also produces a sound in the audible range).

The 'ultrasound' picked up by the transducer is amplified and applied to a product detector. An astable multivibrator is used, since the BFO stability is of minor importance. Apart from the required difference signal, the circuit also produces the BFO signal itself and the sum signal, the latter two being rejected in a low pass filter set at 4 kHz.

## ultrasonic detector

The resulting signal is once more amplified to drive a pair of headphones. The circuit draws about 8 milliamps, so it can be run from a dry battery.

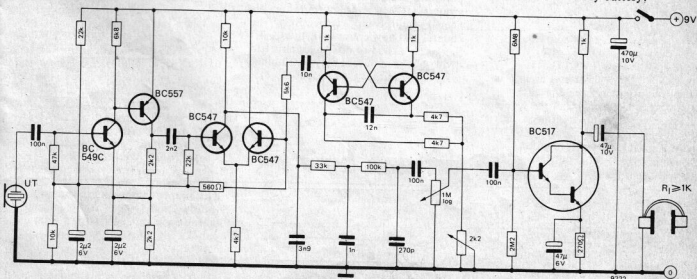

UT = Ultrasonic Transducer  
(e.g. VALVO type 8222 293 18281)

# 66

The 7490 contains two independent (except for reset function) counters, a divide-by-two (flip-flop) and a divide-by-five counter. These may be used separately, or cascaded to form a divide-by-ten counter.

For use as a divide-by-two counter, the input count is fed into input A (pin 14) and the output is taken from output A (pin 12). For a divide-by-five counter the input is to pin 1, and a binary output sequence is obtained at pins 8, 9 and 11.

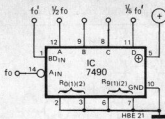

## division by 2,5 and 10

There are two methods of connecting the IC as a divide-by-ten counter. The divide-by-two counter may be connec-

ted before the divide-by-five counter (pins 12 and 1 linked, and the input connected to pin 14). In that case a BCD count sequence is obtained at pins 8, 9, 11 and 12, in accordance with the truth table. If a symmetrical square-wave output is required for frequency synthesizer or other applications then the divide-by-two stage is connected after the divide-by-five stage. In that case input BD (pin 1) receives the input count. The D output (pin 11) is connected to input A (pin 14) and the symmetrical square-wave output is obtained from the A output (pin 12).

In order for the counter to function the reset 0 and reset 9 inputs (pins 2, 3, 6 and 7) must be grounded.

# 67

For division by 3 the counter must reset to 0 when the BCD output is 3 (i.e. 0011). The counter is therefore connected in the BCD (non-symmetrical) divide-by-ten mode, but the reset 0

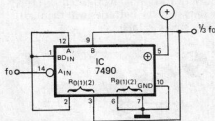

## division by 3

inputs (pins 2 and 3) are connected to the A and B outputs, pins 12 and 9 respectively. The reset 9 inputs remain grounded. Asymmetric divide-by-three output, pin 9.

# 68

Division by 4 requires the counter to be reset to 0 when the output reaches 4 (BCD 0100). The reset 0 inputs are thus both connected to the C output (pin 8).

On the fourth count pulse output C will momentarily become '1', but the counter will then immediately reset to zero. Asymmetric divide-by-four output, pin 9.

## division by 4

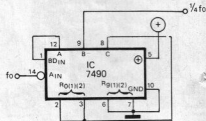

# 69

As with division by 3 and by 4, the DCBA output of a 7490 can be exploited to give a reset to 0000 at every sixth count. The binary output at this count is DCBA = 0110; i.e. C and B

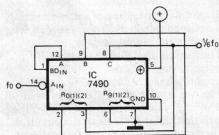

are both '1' for the first time. Outputs B and C are thus connected to pins 2 and 3 respectively. Asymmetric divide-by-six output, pin 8.

## division by 6

# 70

Since in BCD code 7 is 0111 it is impossible to provide a reset every 7 input pulses using only the 2 reset 0 inputs, since using only 2 of the bits in the code would lead to confusion with 3, 6 or 5. It is, however, possible to achieve a divide-by-seven function, though not with a BCD output sequence. Use is made of the reset 9 in-

puts, and the reset 0 inputs are grounded. The C and B outputs are connected to pins 6 and 7 respectively. The counter will now count 9, 0, 1, 2, 3, 4, 5, 9, 0 . . . . and so on. An asymmetric divide-by-seven output may be obtained from either output C or output D.

## division by 7

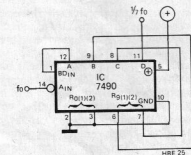

# 71

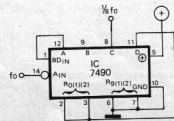

This simply entails connecting output D (pin 11) to the reset 0 inputs. Asymmetric divide-by-eight output from output C.

## division by 8

72

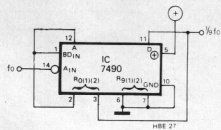

## division by 9

Since the BCD code for 9 is 1001 outputs A and D must be connected to pins 2 and 3 respectively. Asymmetric divide-by-nine output from output D.

73

The 7493 may be used for division ratios up to 16 since it contains a divide-by-two and a divide-by-eight counter. The pin connections are identical to those of the 7490 except that no reset 9 inputs are provided. The following additional division ratios can be obtained with no external gating.

## Division by 12

Outputs C and D connected to the reset inputs, pins 2 and 3 respectively. Asymmetric divide-by-twelve output, pin 11.

## Division by 16

Counter connected as for 7490 in divide-by-10 mode.

## use of 7493 instead of 7490

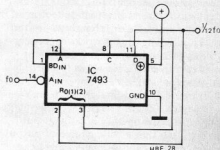

74

## time signal simulator

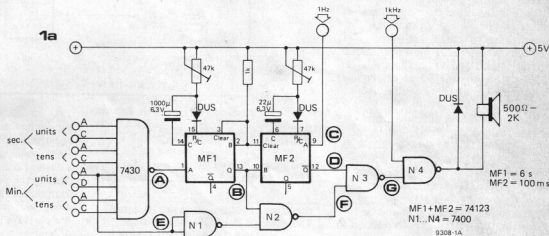

This circuit generates a 'six pips' signal indicating the exact hour.

At the instant the first 'pip' is to start, an eight-input NAND gate, which receives BCD-coded minute and second marks from a TTL clock, transmits a negative-going edge to MF1 (at A). Each digit requires not more than two inputs, the logic '1' level only being used for decoding. The code shown in the diagram corresponds to the moment 59' 55".

The period of MF 1 monostable is about 6 seconds. During this period monostable MF 2 is triggered by a 1 Hz signal at (C), as shown in the pulse diagram, its B input being logic '1' (B). The MF 2 monostable period has been set to about 100 millisecond, which permits MF 2 to be triggered every second. The result is a signal at (D).

Until the turn of the hour, the minute-unit mark remains logic '1' (E), N1 inverts this level, causing the signal at (F) also to be '1'.

At the instant 00' 00", N2 by-passes MF 2. This means that MF 2 only determines the length of the first five 'pips'. The length of the sixth 'pip' is determined by the remainder of the MF 1 period (G). The new hour is, thus, marked by a 'pip' of a length of about 1 second.

The tone itself appears at the input of N4. If the clock is crystal controlled it may be possible to derive a frequency of

around 1 kHz from the divider circuitry in the clock. Otherwise a simple 1 kHz multivibrator may be used.

1b XX: 59:55 XX: 59:56 XX: 59:57 XX: 59:58 XX: 59:59-XX: 00:00 XX: 00:01

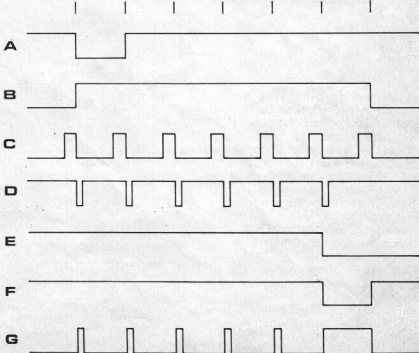

## 75

The integrated circuit LX 5700 is a temperature sensor with a working range extending from  $-55^{\circ}\text{C}$  to  $+125^{\circ}\text{C}$ . The package includes the sensor, an op-amp and an active reference potential source (figure 1). Two transistors operating under similar conditions but at different collector currents will have different base-emitter potentials. The sensor works according to this principle, the transistors being matched in such a way that the output voltage (measured between points A and B in figure 1) rises linearly by 10 mV per degree Kelvin. The inverting input of the internal op-amp is brought out to pin 2, so that a wide choice of output characteristics and working ranges can be preset.

If the op-amp is used as a comparator, its output condition changes when the sensor output voltage  $V_S$  (which is proportional to sensed temperature) exceeds the externally-preset threshold voltage. The LX 5700 thus acts as a temperature monitor, which can be used to switch warning lights or equipment on and off.

In the circuit shown in figure 2, the working temperature range can be set by the voltage divider R1, P1, R2. With the values given, a switch-over point between  $+15^{\circ}\text{C}$  and  $+60^{\circ}\text{C}$  can be set with P1. Other working ranges are possible, if new values are calculated for the voltage divider. It should be noted that the voltages are in relation to pin 3 of the LX 5700, not to supply common!

The ceramic capacitor C2 serves to suppress interference voltages. R3, R4 and D6 determine the hysteresis, which is  $1^{\circ}\text{C}$  with the values given. Reducing

LX 5700



bottom view

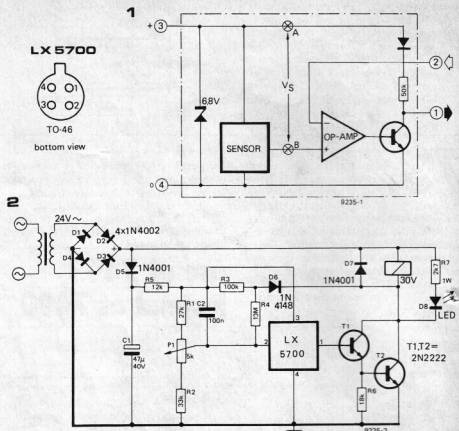

## temperature monitor

the value of R4 increases the hysteresis. The external Darlington pair T1 and T2 drives a relay with which, for example, switching operations can be initiated or an alarm set off. An LED, in parallel with the relay coil, gives an optical indication. The relay and the LED are fed with pulsed DC; C1 only smooths the

supply to the LX 5700. R5 determines the dissipation in the internal voltage stabilizer; it should be chosen to give a current consumption of about 3 mA. Among the possible applications of the temperature monitor are: monitoring room temperature or the water temperature in a bath, remote control of heating installations, or giving an alarm if the temperature rises above or drops below a preset level. Electronic thermometers can also be constructed with the LX 5700 IC.

(National appl)

## 76

The pin connections of the 74121 (monostable multivibrator) are the same for 'dual in line' and 'flat package'. A1, A2, and B are control points. Inputs A1 and A2 are intended for rapid triggering edges ( $1\text{V}/\mu\text{s}$ ). Input B can be used for relatively slow variations in level ( $1\text{V}/\text{s}$ ). The conditions under which the monostable produces a pulse are given in the tables.

The arrow indicates what variation is required in the given situation to make the monostable function.

Together with the internal capacitance and resistance, resistor R1 and capacitor C1 govern the pulse width. The graph shows the output pulse width as a function of the value of external capacitor C1, with a fixed value for R1. The straight line 'R1 = 0' on the graph is related to the configuration in which

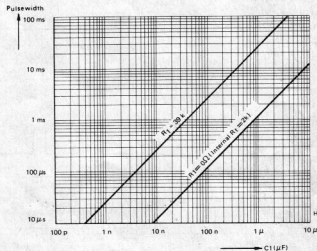

$$\begin{matrix} 1 = 5\text{V} \\ 0 = 0\text{V} \end{matrix}$$

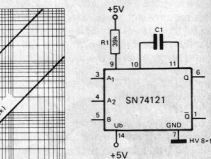

A1	A2	B old	B new
0	0	0	→ 1
1	0	0	→ 1
0	1	0	→ 1

B	A1 old	A2 old	A1 new	A2 new
1	1	1	→ 0	1
1	1	1	→ 1	0
1	1	1	→ 0	0

pin 9 of the IC is connected direct to the supply. R1 may have a maximum value of 40 k.

## the 74121

# 77

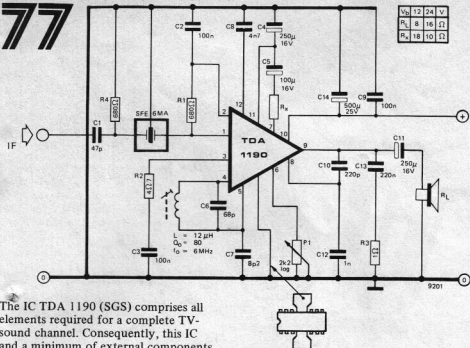

The IC TDA 1190 (SGS) comprises all elements required for a complete TV-sound channel. Consequently, this IC and a minimum of external components are sufficient to build a circuit that amplifies and detects the intercarrier sound of the TV and drives a loud-speaker directly.

The TDA 1190 consists of the following parts:

- IF limiter/amplifier
- active low-pass filter
- FM demodulator
- AF volume control
- AF preamplifier
- AF output amplifier.

Since the specifications of the IC are practically constant for the range between 4.5 and 6 MHz, it can be used in all types of TV set.

The diagram shows a circuit designed around a TDA 1190 that, in spite of its simplicity, is the complete audio section of a TV-receiver. The circuit can be driven by a supply voltage of 12 V or 24 V; the respective LF output powers are then 1.5 W (into 8 Ω) and 4.2 W

(into 16 Ω). Owing to the high input impedance of the IC, the required selectivity can be obtained by means of a ceramic filter (for instance the Murata type SFE 6.0 MA). The value of  $R_x$  determines the gain of the AF amplifier. This offers the possibility of setting the gain in accordance with the maximum frequency deviation. Capacitor C10 determines the upper audio cut-off frequency. C8 and an internal resistor together form the de-emphasis network. The input sensitivity is about 30  $\mu$ V. The AM suppression is 55 dB and the

## IC tv-sound channel

signal-to-noise ratio about 70 dB. The input impedance is about 30 kohm. At a supply voltage of 24 V, a loud-speaker impedance of 16 Ω and a value of 18 Ω for  $R_x$  the frequency range is from 50 to 12000 Hz (within 3 dB); at  $R_x = 10 \Omega$  the range is from 50 to 9000 Hz.

At a supply voltage of 24 V and an output power of 50 mW distortion is 0.55%; at full power this percentage increases to about 10%.

The IC is provided with two cooling fins which can be mounted on a suitable heat sink. One of the fins must be connected to supply common.

# 78

It is possible to imitate an inductor, using a capacitor and a gyrator. This arrangement uses a Miller integrator and a passive differentiator instead.

The component values must be so chosen that  $R1C1 = R2C2 = \tau$ . In this case the impedance developed between the points A and B will be  $j\omega P1\tau$ . This is

## variable inductance

an inductance of value  $L = P1 \cdot \tau!$

The value of  $R1 (= R2)$  should be taken somewhere between 5k6 and 22k. In some applications the voltage follower (IC2) can be omitted.

If  $R2$  is made adjustable it will be possible to achieve maximum quality factor by precisely balancing the circuit. When the dashed components are added the circuit becomes a simple hum-rejection filter. Careful adjustment of  $P1$  and  $R2$  can enable 50 dB of attenuation to be obtained at 50 Hz, with 3 dB attenuation at 40 Hz and 62 Hz.

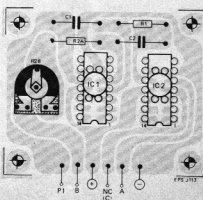
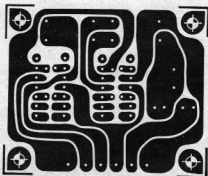
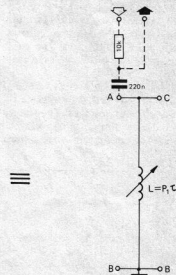
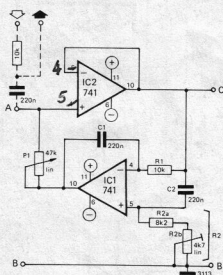

## 79

The integrated circuit LM 3909 used in this device is a relatively inexpensive monolithic oscillator in an 8-pin DIL package. The original concept is intended for low current LED flashers, powered by a 1.5 volt source. The IC internal circuitry (figure 1) shows a current limiting resistor for the LED (100  $\Omega$  to pin 8) and two resistors R2 + R3 in series, which can be used for the delay function. The whole flashing circuitry of figure 2 needs only two components plus a single 1.5 volt cell. Capacitor C sets the flashing frequency, which is about 1 Hz in this case. The current consumption is so low that one battery should last a year. The LED flasher is a very handy device for locating, in the dark, appliances such as fire extinguishers, key lockers and the like. It can also be used as a warning light for model railways.

As a general rule, the flashing frequency depends to a large degree on the accurate capacitance and quality of the electrolytic capacitor. It will, therefore, take some experimenting to arrive at a

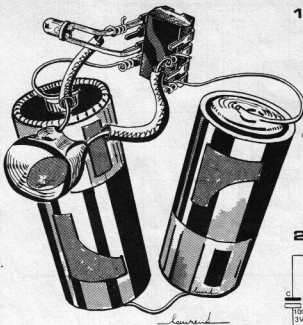

## LED flasher

specific frequency. It has been found that capacitors with a high leakage current impair the operation. Best results

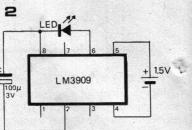
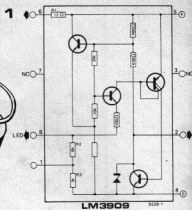

are obtained with tantalum electrolytics, which have the added advantage that they are very small.

(National Semiconductor)

## 80

Many electronic devices have no provisions for the 1.5 V power supply for the LED flasher. Two resistors can, in that case, be added enabling the circuit to operate at higher voltages. The resistance values depend on the voltage available.

The following table shows the values of the components required to operate the circuit at different voltages. The last column indicates the range of voltages over which the circuit will work satisfactorily.

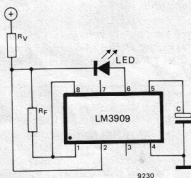

Table

Supply voltage (V)	Flashing frequency (Hz)	C ( $\mu$ F)	Rv ( $\Omega$ )	Rf ( $\Omega$ )	Operating range (V)
+ 6	1.6	470	1 k	1k5	+ 5 ... 25
+ 15	1.6	220	3k9	1 k	+13 ... 50
+100	1.3	220	43 k/ 1 W	1 k	+85 ... 200

## LED flasher for higher voltages

## 81

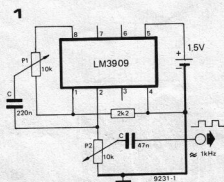

A further application of the LM 3909 circuit is a 1 kHz square-wave oscillator.

P1 is used for making the square-wave symmetrical. P2 sets the amplitude of the output signal; the maximum is about 1.1 volts (peak-to-peak).

## 1 kilohertz oscillator

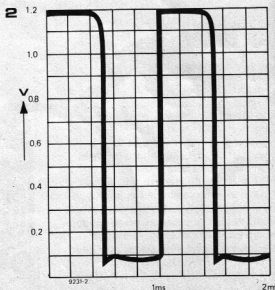

# 82

This miniature device consists of only four components. It can be used for continuity tests in wiring harnesses and on p.c. boards, using suitable test prods connected to points A and B. After some experience it is possible to estimate contact resistance by interpreting differences in pitch and sound level.

A further application is, to use the mini-siren as a morse code practice set by connecting a morse key between A and B.

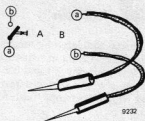
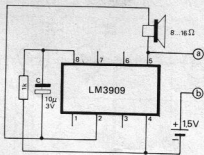

## mini-siren conductance tester

# 83

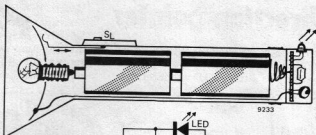

The 'find me' device enables a pocket flashlight to be found in the dark. The circuit is powered by the flashlight battery (see drawing).

Pin 5 of the IC is connected, via an insulated wire, to the reflector;

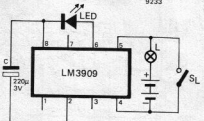

pin 4 is connected to the spring contact of the case. The current for the IC flows through the torch bulb.

## attachment for 'find me' flashlights

# 84

Many amplifier designs, both do-it-yourself efforts and commercial circuits, have the bad habit of delivering a more or less hefty switch-on 'thump'. This is usually due to too-rapid charging of the output-electrolytic. If this fault occurs in a high-power design

## slow-rise power supply

there is every chance of loudspeakers departing for Valhalla.

An alternative to redesigning the offending amplifier is given by this power-supply circuit. It is essentially a simple regulator with a slow-start characteristic.

The raw supply is delivered by rectifier B and reservoir capacitor  $C_V$ . Zener-diode D1 provides the reference voltage, the output voltage being about 600 mV lower than this. If necessary the desired voltage can be made up using two zeners in series. The total zener voltage may be chosen between 28 V and 63 V (roughly). Switch S1 turns the supply on and off (coupled to the mains switch). When it is closed the voltage on C1 rises in about 1 second to its

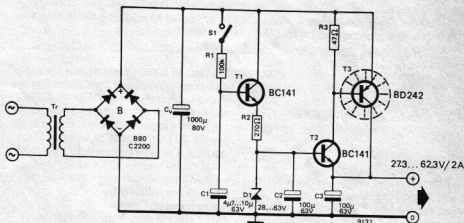

operating value. The output voltage follows it up until the point is reached at which the zener becomes conductive. When S1 is opened the voltage on C1 falls away in about 5 seconds, due to base current supplied to T1. If the amplifier shows no serious switch-off transient, so that well-defined turn-off is not required, it is permissible to omit S1.

The unregulated voltage at C1 should not exceed 80 V. It should be chosen so that there is just enough voltage drop across T3 to take care of regulation requirements. Too high a drop is a waste of power and - much more important - a waste of expensive heat sink. The idea is that with the supply fully loaded and the incoming mains voltage at its lowest

(expected) value, there should be about 2 volts across the series transistors at the troughs in the ripple waveform.

A reasonable rule of thumb, alternatively, is to allow about 10 volts across T3 (no load) - and hope! T3 will in any case need a modest heat sink (e.g. 2 mm thick bright aluminium, about 10 cm by 10 cm). In extreme cases it may also be necessary to provide T2 with a cooling vane or clip.

The value of 1000 µF given for  $C_V$  is only intended as an illustration. If one is going to also build the raw supply, matched to a known maximum load, there is not much else for it but a little mathematical exercise with  $Q = CV$  (remembering that the rectifier delivers one hundred wallops-per-second).

## 85

W. Lewald

The direction is indicated by means of four lamps that flash on in sequence: one-two-three-four-out. T1 and T2 form a multivibrator whose period determines the rate at which the lamps 'flash forward'.

At switch-on all the thyristors are non-conductive. The first positive-going flank at the collector of T1 will trigger thyristor Thy1, causing lamp L1 to light up. The same trigger-pulse is also applied to Thy3 — but this will cause no anode current to flow, because Thy2 is still non-conductive. The next change of state of the multivibrator produces a positive-going flank at the collector of T2, and this will trigger Thy2 and light L2. L3 and L4 come on during the second cycle of the multivibrator. Now all the lamps are burning, having come on one-by-one. There is

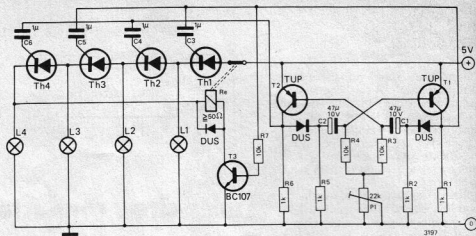

## direction pointer

now a positive voltage at the collector of T3, so that the next pulse will cause the relay to attract. This will interrupt

the feed to the thyristors, quenching all the lamps, so that the sequence can start again.

One must take care that the thyristors are adequately rated for the lamp load. Bear in mind that Thy1 has to carry the current for all four lamps; Thy2 the current for three, etc.

## 86

In principle an OR-gate can consist of cathode-connected diodes with one resistor to the supply neutral. A drawback of such a circuit is that its properties are not the same as those of TTL or COS/MOS. If such is required, the circuit of figure 1 can be applied with TTL-circuits; the one of figure 2 with COS/MOS. The number of inputs of the

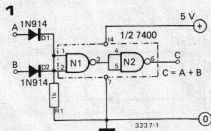

circuits of figure 1 or 2 can, of course, be extended by adding a diode for each additional input.

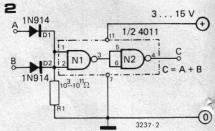

## NAND OR gate

## 87

J.W. Gnodde

The designer of a heavy-duty, variable-voltage, regulated power supply unit always meets the problem of having to allow for the very high dissipation that can occur in the series regulator transistor. When a high output current is drawn at low voltage (TTL!) it may even be necessary to use a cooling fan at the heatsink.

Perhaps an extreme example is the case of a supply unit capable of delivering 5 amps at between 5 and 50 volts. Such a unit will have typically a 60 volt unregulated supply. Suppose this unit is to supply TTL circuits at its full rated current. The series element in the circuit must now dissipate 275 watts! The cost of providing adequate cooling is likely to be exceeded only by the cost of the series transistor needed.

If the voltage drop across the regulator transistor could be limited to 5.5 volts, independently of the selected output voltage, the dissipation would be drastically reduced — in the above example to

10% of its original value.

This can be achieved by using three semiconductor devices and two resistors (figure 1).

This is what happens: thyristor Thy is normally kept conductive by means of R1. However, when the voltage drop across T2 — the series regulator — exceeds 5.5 volts, T1 will start to conduct, causing the thyristor to 'open' at the next zero-crossing of the rectifier output. This arrangement continuously controls the charge supplied to C1 — the reservoir capacitor — so that the unregulated supply is held at 5.5 volts above the regulated output voltage.

The value required for R1 is found as follows:

$$R_1 = \frac{1.4 \times V_{\text{sec}} - (V_{\text{min}} + 5)}{50} \text{ k}\Omega,$$

where  $V_{\text{sec}}$  is the RMS secondary voltage of the transformer and  $V_{\text{min}}$  the minimum value of the regulated output. The thyristor must be capable of carrying the peak ripple current, and its working voltage must be at least 1.5  $V_{\text{sec}}$ . The series regulator transistor must be rated to carry the maximum output current,  $I_{\text{max}}$ , and be provided with a heatsink on which it can dissipate 5.5  $\times I_{\text{sec}}$  watts.

## heatsink shrinker

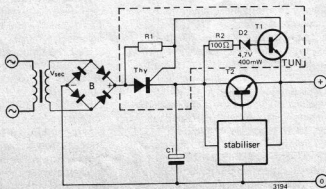



88

The CA 3090 Q, an integrated PLL stereo decoder, has been quite popular for the last four or five years. Not long ago RCA introduced a new, improved version: the CA 3090 AQ. The most important improvement is a reduction in harmonic distortion from 0.35% down to 0.2%.

A complete circuit with the new IC is shown in figure 1: figures 2a and 2b show the two basic ways of connecting pins 3 and 4. If these pins are connected to supply common (figure 2a), the circuit performs as a normal stereo decoder; however, one or two minor additions (figure 2b) give a stereo-defeat option: if the voltage on pin 4 is less than 0.9V the decoder will not operate,

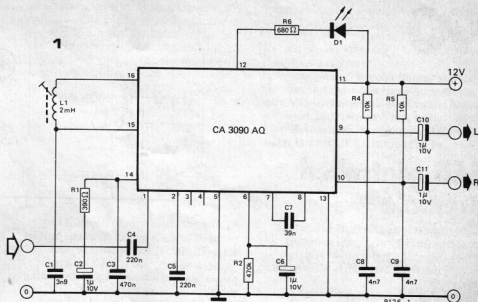

## CA3090 AQ stereo decoder

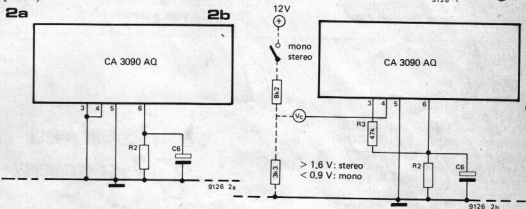

so that the output remains mono.

A voltage greater than 1.6 V on pin 4 switches the decoder back to normal operation. This option can be used for an automatic stereo-defeat, driven by a carrier-level dependent reference voltage, or simply as a manual switch as shown in figure 2b.

The p.c. board (figure 3) allows for both possible connections to pins 3 and 4. Mounting the (dotted) wire links gives

the circuit of figure 2a; if R3 is mounted, the stereo/mono control voltage can be connected to Vc. The trimming procedure is as follows: 1. Connect the decoder to the audio output of an FM receiver. NB. The original de-emphasis network in the receiver should be removed, of course! 2. Tune in to a stereo broadcast - if necessary, this can be checked with the aid of a second receiver.

3. Screw the ferrite core of L2 out as far as possible. 4. Now screw the core down until the LED (D1) lights up; screw the core still further, counting the number of turns, until the LED goes out again; finally, set the core midway between these two extreme positions. Of course, if one has access to a good oscillator and frequency counter, the coil can simply be tuned to 76 kHz.

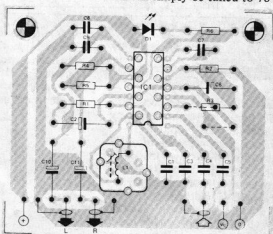
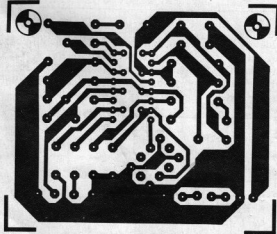

89

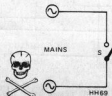

## fuse destroyer

## 90

Existing tremolo controls using an incandescent lamp and a light-dependent resistor have a response too slow to follow a fast and deep tremolo. New possibilities are opened by the availability of light-emitting diodes and rela-

## LED controlled tremolo

tively fast responding light-dependent resistors (mostly of Japanese origin). Obviously, a LED permits luminance variations much faster than a filament lamp.

The circuit diagram shows an RC oscillator T1 with control P2 setting the tremolo frequency between 2 and 9 Hz.

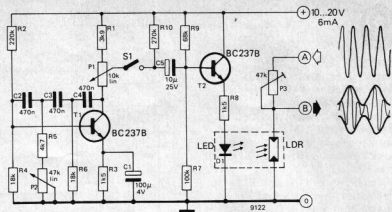

P1 controls the tremolo depth. The tremolo signal is admitted to the buffer stage T2 via S1, which switches the tremolo on/off, and C5. T2 emitter passes the tremolo signal plus a standing current via R8 on to the LED.

The LED is optically coupled to the LDR. The optical path is screened from

external light.

The tone signal entering at A is modulated by the tremolo controlled LDR when it arrives at the output end B. P3 pre-sets the range of the tremolo depth. Transistors of an equivalent type can be used for T1 and T2 (e.g. BC 107B, 108B, 109B).

## 91

In a previous issue (Elektor 2) the principle of improved readability for 7-segment displays was explained. The idea is to add an extra stroke at the top of a six and at the bottom of a nine (figures 1, 2 and 3).

The circuits given there were based on the TTL decoder driver SN 7447, and derived the necessary 'logic' information from the BCD inputs. In many monolithic integrated circuits, such as the MOS-clock IC MM5314, only segment-drive outputs are accessible however — and moreover these outputs deliver a sequentially multiplexed signal for all four (or six) digits. In this case, a different approach to 'improve readability' is required.



1

2

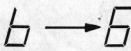

9103-2

3



9103-3

## improved 7-segment for MOS-clocks

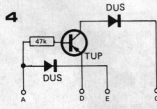

9103

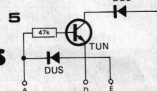

9103

The circuit in figure 4 can be used with common-anode displays, as in the MOS-clock. The points A, D, E and G are connected to the collectors of the

corresponding segment-drive transistors (T1, T4, T5 and T7 in the MOS-clock). For common-cathode displays the circuit of figure 5 can be used.

## 92

H. Dirks

Programmable frequency dividers are particularly useful for producing a large number of frequencies from one reference frequency. An example of the type of circuit in which such dividers can be used is a frequency synthesiser. Programmable dividers are generally rather expensive. The circuit given here offers a less pricey solution. In this instance, two 7490s connected in cascade are made programmable by providing a switchable reset point. This is achieved by connecting the BCD outputs of the two dividers to the reset inputs through diodes, and presetting the required division ratio by closing one or more switches. When, and only when all the outputs connected to closed switches go '1' simultaneously, the diode anodes all become free to rise

in potential and the reset operates. For example; the circuit divides by 75 when the switches for IC1 are set to DCBA (5 = 0101) and the switches for IC2 are set to DCBA (7 = 0111). Each bar indicates an open switch; the other

switches should be closed. When the divider count reaches the number which has been preset, both R<sub>01</sub> inputs go to logic '1' and the dividers are reset. Both dividers then start again from the beginning.

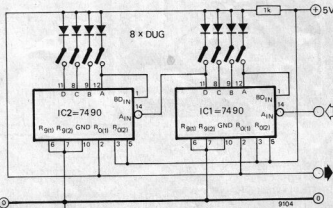

## programmable frequency divider



## 95

The use of a unijunction transistor in a sawtooth generator is well known. By way of variation, this circuit uses a diac. One specific property of the diac is its high breakdown voltage. While a normal diode will conduct at a forward voltage as low as about 0.5 V, a diac's threshold can be as high as 30 V. A diac shunted across a steadily charging capacitor will abruptly discharge it every time the breakdown voltage of the device is reached.

If the charging of the capacitor is done by means of a current-source, the voltage wave across it will be a sawtooth with an amplitude equal to the break-

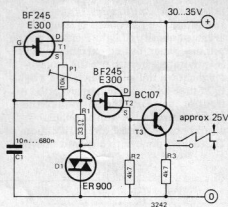

## diac sawtooth-generator

down voltage. A resistor in series with the diac protects it against excessive peak current.

Any load connected directly in parallel with the capacitor will spoil the linearity of the sawtooth. The voltage-follower combination of JFET and bipolar transistor solves this problem by providing an extremely high input impedance and a very low output impedance.

The specified E 300 FET's can actually be replaced by almost any other type; the circuit merely uses fundamental FET properties.

A good sawtooth contains all even and uneven harmonics of the fundamental frequency — so that this generator can produce interference far into the VHF range. It must be screened!

## 96

Ch. Voss

This volume-control circuit offers an unusual approach to the well-known problem of distortion in active-device attenuators. The zero-output in this case is obtained by allowing equal signals of opposite phase to cancel each other. The input transistor operates as a 'concertina' phase-splitter, producing equal-amplitude opposite-phase voltages at its collector and emitter. The two signals can be brought into complete cancellation, at the summing point, by means of preset P1. The harmonic content of the two signals is very small — but not quite identical. There will therefore actually be an — even smaller — distortion output at the nominally 'zero' point.

If something now happens to the amplitude ratio of the signals at the summing point, there will be output passed to the buffer-stage. The necessary unbalance is achieved by means of the JFET and capacitor C2. The gate bias on the FET is set by the DC control voltage applied to point A. With this voltage close to

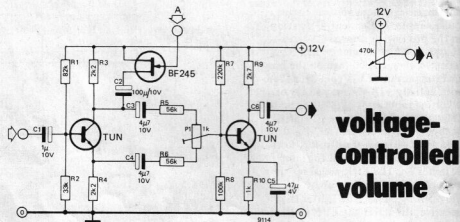

## voltage-controlled volume

zero the FET will be cut off, so that the above-mentioned cancellation takes place. As this voltage is increased there will come a point at which the channel starts to 'bleed off' AC collector current from the splitter; this will upset the balance and so cause an output signal to appear. The more conductive the FET, the more output. Unfortunately, the more channel current there flows the lower will be the negative gate bias — and so the greater will be the distortion of the 'regulated' summing component. The trick is now to employ only a

moderate degree of unbalance — so that the FET operates at low distortion percentages. The process is helped also by the always-present 'clean' summing component. The buffer stage provides gain, so that a sufficient output level is obtained.

The circuit's frequency response extends from 50 Hz to 35 kHz (— 3 dB points). The input voltage should be limited to 100 mV p-p; the output can be varied from '0' to 1 V p-p (by using the appropriate range for the control voltage at A).

## 97

R. Meschenmoser

The circuit consists of an 'electronic' attenuator, arranged to respond to a fingertip touching one of its contact plates.

Transistor T1 (a type E300 or similar JFET) operates as the variable resistor in a voltage divider (T1, R1). The channel resistance of T1 depends on the negative voltage across C1.

If one touches the contact-pair associated with the negative supply a current through D2, R2 and D3 will charge the capacitor. The charging time is determined by the values of R2 and C1. When the FET gate is biased sufficiently negative the device will no

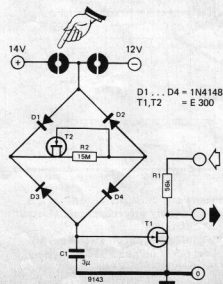

longer conduct, so that the audio signal passes unattenuated.

To reduce the audio volume one simply touches the 'positive' contact-pair. The discharge of C1 causes the FET-bias to be reduced, so that the channel becomes conductive again and diverts signal current to 'earth'. The level will continue to slowly change as long as one of the contact-pairs is being touched. The FET channel is only approximately a linear resistor, due to the audio signal modulating the gate bias. At an input level not exceeding 30 mV there will nonetheless be no audible distortion.

## fingertip volume control

98

B. Selhorst

This instrument has 14 capacitance measuring ranges, from 5 pF f.s.d. to 15  $\mu$ F f.s.d., and a linear scale. S1 is the main range switch, and works in combination with S4 ( $\times 1/\times 10$ ) and S3 ( $\times 1$ ) or S2 ( $\times 3$ ).

The 7413 works as an AMV, with R1 and C1 ... C6 as frequency-determining components. This in turn triggers the 74121 (a monostable multivibrator) so that it produces an asymmetric square-wave, the repetition frequency of which is determined by R1 and C1 ... C6 and with a pulse width determined by R2 (or R3) and C<sub>X</sub>. The average value of

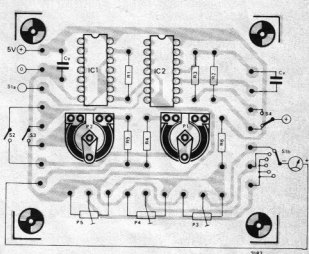
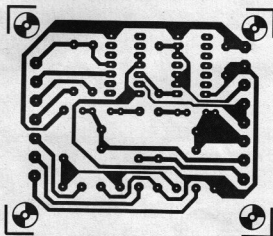
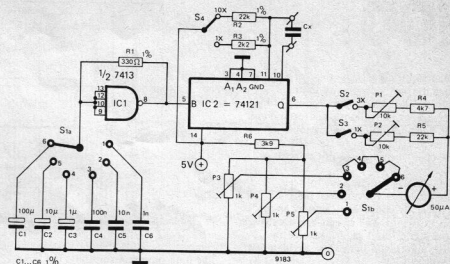

this square-wave voltage is a linear function of the duty cycle, which in turn is linearly dependent on the value of C<sub>X</sub>, the value of R2/R3 ( $\times 10/\times 1$ ) and the frequency (determined by the position of S1). The final range selector switches S3 ( $\times 1$ ) and S2 ( $\times 3$ ) simply add a resistor in series with the meter.

The wiring to pins 10 and 11 of the 74121 and to C<sub>X</sub> should be as short and rigid as possible, so that the parasitic capacitance at this point is small and constant. P5 and P4 are used for separate zero calibration in the low capacitance ranges; for all higher ranges one calibration (with P3) suffices.

F.s.d. calibration is fairly simple. Do not

## capacitance meter

solder C6 in circuit but connect it across the C<sub>X</sub> terminals. Set S1 in position 3, S4 in position  $\times 1$  and S2 closed ( $\times 3$ ); this corresponds to 1500 pF f.s.d., so that C6 can be used as a calibration standard, and P1 is adjusted so that the meter reads 2/3 of f.s.d. After this, S4 can be set in position ' $\times 10$ ', S2 is opened and S3 is closed ( $\times 1$ ); this

corresponds to 5000 pF f.s.d., so using C6 as C<sub>X</sub> will give 1/5 of f.s.d. Alternatively a range of standard capacitors may be incorporated into the instrument for calibration purposes.

Editorial comment: although the author specifies 100  $\mu$ /1%, 10  $\mu$ /1% and 1  $\mu$ /1% electrolytics for C1, C2 and C3, we fear that these will not be readily obtainable.... For C2 and C3, 5% polycarbonate types can be used instead; if the highest range is also required C1 can be individually calibrated (with extra padding capacitors) using C3 as calibration standard. Of course, the temperature stability of an electrolytic will always remain questionable.

99

A. Dreton

By means of the IC TAA 131 and a few external components a simple square-wave generator can be built which is eminently suitable for testing amplifiers, for instance.

The circuit operates well on a voltage of 1.5V, but it is still reliable with a supply voltage of about 1 V. Consequently, it is possible to build the entire circuit plus the battery (mercury cell!) into a small case.

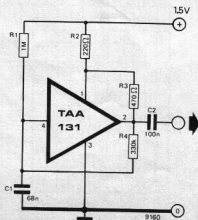

The frequency generated is about 1000 Hz but, because the output signal is a good square-wave, harmonics as high as 1 MHz will be present.

Choosing a larger value for C1 or R1 gives a lower frequency, and vice versa.

## mini signal squirt

The amplitude of the square wave at the output is practically equal to the supply voltage. The symmetry is somewhat dependent on the supply voltage.

## 100

This circuit adjusts the brightness of an incandescent lamp to suit ambient lighting conditions. This is useful for instrument panel lights, bedroom clock lighting and similar applications.

The circuit is designed for 6-24 V lamps; the total current must not exceed 1 amp.

The adapter functions as follows. LDR 1 senses the ambient light. LDR 2 is optically coupled with an incandescent lamp. The circuit balances when both LDR 1 and LDR 2 receive the same amount of light. The circuit must, however, cause the external lamp(s) to be brighter than the ambient light. For this reason L1 should have a lower current rating than L2, L3 etc; or, failing this, a small screen (small sheet of paper) can be placed between the lamp (L1) and the LDR inside the optocoupler.

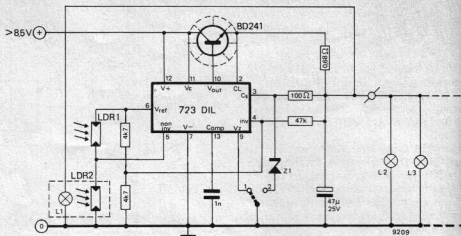

The 0.68 ohm resistor limits the lamp current; the 1 nF capacitor prevents oscillation of the circuit. The circuit must be powered by at least 8.5 volts;

lower voltages affect the operation of the IC. It is recommended to use a supply that exceeds the lamp voltage by about 3 volts.

The zener (Z1) is chosen to match the lamp voltage; for 6 V lamps the internal zener in the IC can be used by grounding terminal 9.

## contrast adapter

## 101

The circuit diagram shows an active-low-pass filter design which can be given any desired cut-off point — over a wide range — simply by calculating two values for four capacitors. The filter consists of an RC-network and an NPN/PNP transistor-pair. The transistor types shown can be directly replaced by many other types without spoiling the circuit's performance. The supply voltage used should be between 6 and 12 V.

## active low-pass filter

The capacitor values chosen for C1 ... C4 determine the cut-off frequency. These values can be obtained from the following two formulae:

$$C_1 = C_2 = C_3 = \frac{7.56}{f_c}$$

$$C_4 = \frac{4.46}{f_c}$$

in which ' $f_c$ ' is the desired cut-off frequency (in Hertz), where the amplitude-response is down 3 dB, and the values for C1 ... C4 are obtained in microfarads. (Inserting kilohertz will deliver nanofarad values and inserting megahertz will produce picofarad values.)

As an illustration the measured result is given for a filter made up with C1 = C2 = C3 = 5n6 and C4 = 3n3. The '-3 dB point' in this case occurs at 1350 Hz. One octave higher, at 2700 Hz, the attenuation is already 19 dB.

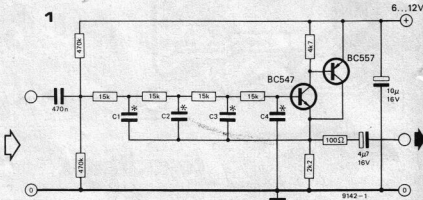

\* see text

2

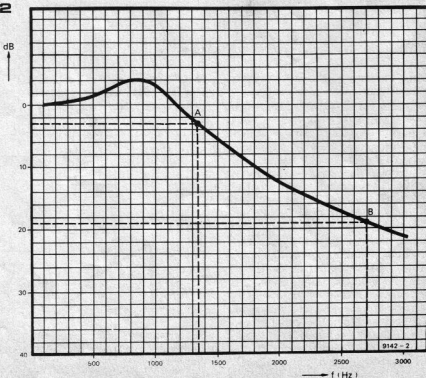

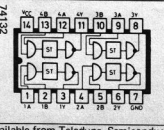
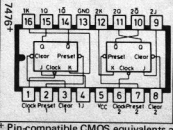
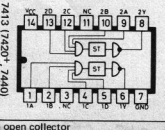
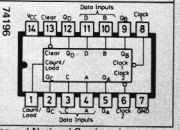
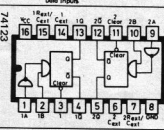
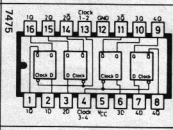
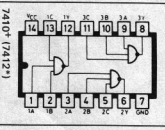
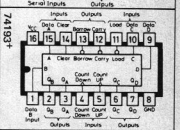
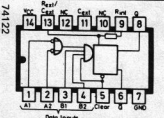
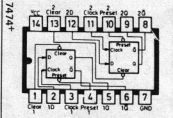
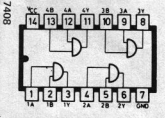
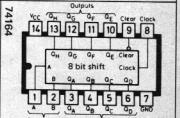
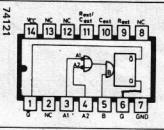
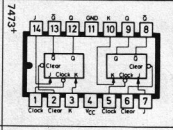
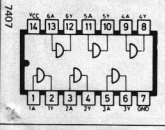
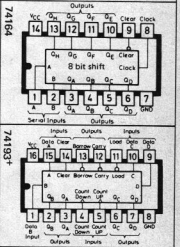
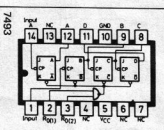
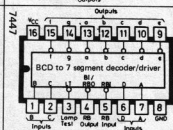
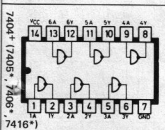
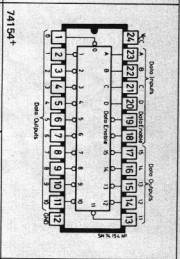
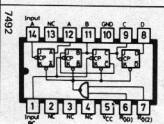
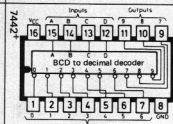
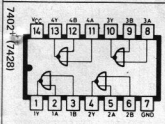
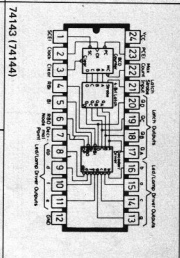
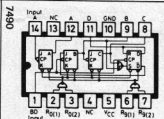
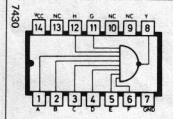
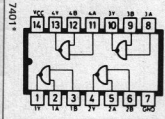
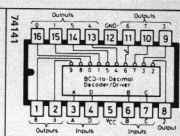
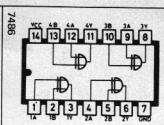
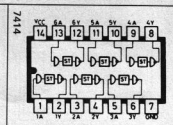
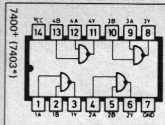

\* open collector

\* Pin-compatible CMOS equivalents available from Teledyne Semiconductor and National Semiconductor

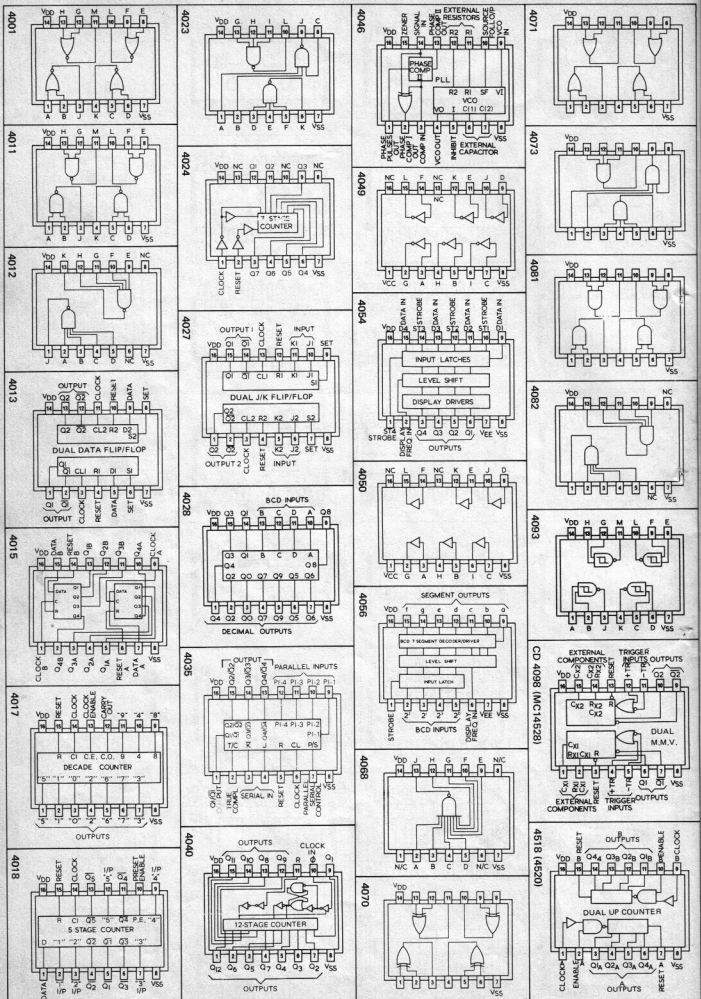

Note: A prefix to the type number denotes the manufacturer, e.g. CD 4001 (RCA), MC 14001 (Motorola), N 4001 (Signetics), SCL 4001 (Solid State Scientific), SIL 4001 (Siltek).





# TUP TUN DUG DUS

Wherever possible in Elektor circuits, transistors and diodes are simply marked 'TUP' (Transistor, Universal PNP), 'TUN' (Transistor, Universal NPN), 'DUG' (Diode, Universal Germanium) or 'DUS' (Diode, Universal Silicon). This indicates that a large group of similar devices can be used, provided they meet the minimum specifications listed above.

For further information, see the article 'TUP-TUN-DUG-DUS' in Elektor 1, p. 9.

	type	$U_{ce0}$ max	$I_c$ max	$h_{fe}$ min.	$P_{tot}$ max	$f_T$ min.
TUN	NPN	20 V	100 mA	100	100 mW	100 MHz
TUP	PNP	20 V	100 mA	100	100 mW	100 MHz

Table 1a. Minimum specifications for TUP and TUN.

Table 1b. Minimum specifications for DUS and DUG.

	type	$U_R$ max	$I_F$ max	$I_R$ max	$P_{tot}$ max	$C_D$ max
DUS	Si	25 V	100 mA	1 $\mu$ A	250 mW	5 pF
DUG	Ge	20 V	35 mA	100 $\mu$ A	250 mW	10 pF

Table 2. Various transistor types that meet the TUN specifications.

TUN		
BC 107	BC 208	BC 384
BC 108	BC 209	BC 407
BC 109	BC 237	BC 408
BC 147	BC 238	BC 409
BC 148	BC 239	BC 413
BC 149	BC 317	BC 414
BC 171	BC 318	BC 547
BC 172	BC 319	BC 548
BC 173	BC 347	BC 549
BC 182	BC 348	BC 582
BC 183	BC 349	BC 583
BC 184	BC 382	BC 584
BC 207	BC 383	

Table 4. Various diodes that meet the DUS or DUG specifications.

DUS		DUG
BA 127	BA 318	OA 85
BA 217	BAX13	OA 91
BA 218	BAY61	OA 95
BA 221	1N914	AA 116
BA 222	1N4148	
BA 317		

Table 5. Minimum specifications for the BC107, -108, -109 and BC177, -178, -179 families (according to the Pro-Electron standard). Note that the BC179 does not necessarily meet the TUP specification ( $I_{c,max} = 50$  mA).

	NPN	PNP
	BC 107 BC 108 BC 109	BC 177 BC 178 BC 179
$V_{ce0}$ max	45 V 20 V 20 V	45 V 25 V 20 V
$V_{eb0}$ max	6 V 5 V 5 V	5 V 5 V 5 V
$I_c$ max	100 mA 100 mA 100 mA	100 mA 100 mA 50 mA
$P_{tot}$ max	300 mW 300 mW 300 mW	300 mW 300 mW 300 mW
$f_T$ min.	150 MHz 150 MHz 150 MHz	130 MHz 130 MHz 130 MHz
F max	10 dB 10 dB 4 dB	10 dB 10 dB 4 dB

The letters after the type number denote the current gain:

- A:  $\alpha'$  ( $\beta$ ,  $h_{fe}$ ) = 125-260  
 B:  $\alpha'$  = 240-500  
 C:  $\alpha'$  = 450-900.

Table 6. Various equivalents for the BC107, -108, ... families. The data are those given by the Pro-Electron standard; individual manufacturers will sometimes give better specifications for their own products.

NPN	PNP	Case	Remarks
BC 107 BC 108 BC 109	BC 177 BC 178 BC 179		
BC 147 BC 148 BC 149	BC 157 BC 158 BC 159		$P_{max} = 250$ mW
BC 207 BC 208 BC 209	BC 204 BC 205 BC 206		
BC 237 BC 238 BC 239	BC 307 BC 308 BC 309		
BC 317 BC 318 BC 319	BC 320 BC 321 BC 322		$I_{c,max} = 150$ mA
BC 347 BC 348 BC 349	BC 350 BC 351 BC 352		
BC 407 BC 408 BC 409	BC 417 BC 418 BC 419		$P_{max} = 250$ mW
BC 547 BC 548 BC 549	BC 557 BC 558 BC 559		$P_{max} = 500$ mW
BC 167 BC 168 BC 169	BC 257 BC 258 BC 259		169/259 $I_{c,max} = 50$ mA
BC 171 BC 172 BC 173	BC 251 BC 252 BC 253		251 ... 253 low noise
BC 182 BC 183 BC 184	BC 212 BC 213 BC 214		$I_{c,max} = 200$ mA
BC 582 BC 583 BC 584	BC 512 BC 513 BC 514		$I_{c,max} = 200$ mA
BC 414 BC 414 BC 414	BC 416 BC 416 BC 416		low noise
BC 413 BC 413	BC 415 BC 415		low noise
BC 382 BC 383 BC 384			
BC 437 BC 438 BC 439			$P_{max} = 220$ mW
BC 467 BC 468 BC 469			$P_{max} = 220$ mW
	BC 261 BC 262 BC 263		low noise

# TUP TUN DUG DUS

# Motorola LED sentries never die.

Unlike filament indicator lamps, Motorola Light Emitting Diodes don't die.

They come in three colours—red, yellow and green—and in viewing angles to suit all applications.

We're so confident of your determination to be up-to-date, that we've invested heavily to give you the LEDs you want, when you want them.

Use indicator lamps that are worthy of your equipment. Use Motorola LEDs as sentries to watch over it.

To find out more about the design possibilities of these high-reliability products, just send for the new Motorola Opto Electronics brochure, which gives you information about our light detectors and couplers too.

You'll find it profitable reading.



**MOTOROLA Semiconductors**

Motorola Semiconductors Ltd., York House,  
Empire Way, Wembley, Middlesex. Telephone: 01-502 8836.  
European manufacturing facilities at Toulouse and East Kilbride.  
Distributors: Ceidix Ltd., Reading, East Kilbride;  
GDS (Sales) Ltd., Slough, Dublin; Jermyn, Sevenoaks;  
Lock Distribution, Gillingham; Semiconps Ltd., Wembley.