

elektor

up-to-date electronics for lab and leisure

81

January 1982

65p.

(FR 85p. (incl. VAT))

**wireless
tv sound**

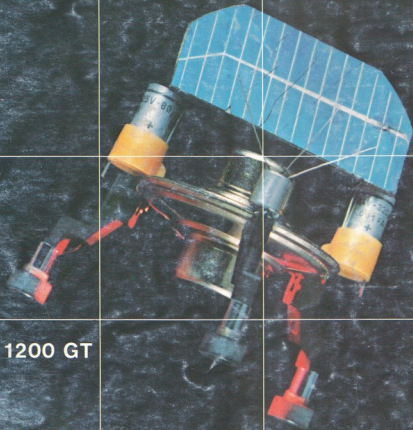

NIBL 1200 GT

**VLF and VHF
frequency counting**

**SPECIAL
OFFER**

details inside

Surinder Singh

selektor 1-12

electronic chimes 1-14
 These chimes are the latest in the field of electronic doorbell technology and produce a harmonious chord made up of three notes.

150 MHz frequency counter 1-17
 The circuit described in this article is a logical extension to the hand-held LCD frequency counter published in the November 1981 issue of Elektor. The two original frequency ranges of 4 MHz and 35 MHz are retained, but a further range allowing a maximum count of 150 MHz has also been included. Furthermore, the circuit here utilises the frequency offset capabilities of the FM77T module to the full, in fact, all 26 of them.

combined VCF/VCA module 1-22
 The VCO module described in the December issue by no means provides a complete synthesiser. The addition of at least one VCA and a VCF is required to obtain a simple playable instrument.

2716/2732 programmer 1-26
 (P.R. Boldt)
 The EPROM programmer described in this article has been designed specifically for the Elektor SC/MP and Junior Computer microprocessor systems. It can be used to program and verify both 2732 devices and the popular 2716s.

induction loop paging system 1-32
 Short range paging systems are normally used in large buildings or by people with very poor hearing. The system described in this article has many more applications: it can be used as a 'wireless' connection for radio or TV sound; as a baby alarm; or even as an intercom system.

mini circuits 1-38
 Four pages of simple circuits with a common purpose - to save money!

guitar amplifier philosophy 1-42
 Guitar sound systems rarely come into the limelight where electronics are concerned, but the musician with a lively interest in our hobby will wonder at what point in the technological progress line his equipment stands at. The answer is surprising since a large percentage of the amplifiers available do not live in today's technology at all, but very definitely yesterday's.

NIBL 1200 GT 1-50
 (W. Taphoorn)
 This article is intended for readers who would like to increase the printing speed of the Elektor BASIC microcomputer. It describes an 'add-on' unit which will enable transmission at speeds of up to 1200 baud. No modification is required to the BASIC microcomputer itself.

single channel infra-red remote control 1-52
 The main features of this remote control system are: an uncomplicated circuit; easy construction; a reasonable range (with or without a focusing lens); and low current drain.

frequency multiplier 1-53
 This circuit allows frequencies below 2 kHz to be measured accurately on a 'normal' frequency counter by multiplying the input signal by a certain factor until it is within the range of the measuring instrument.

applikator 1-56
 Small is beautiful in the case of the tiny AM/FM receiver described in this article. It uses the TDA 1220A IC from SGS-Ates and produces a surprisingly good sound quality for its size.

colour LCDs 1-58
 Thanks to a new development in liquid crystal technology, displays are now available in a variety of bright colours.

missing link 1-59

market 1-60

Elektor special offer 1-63

contents

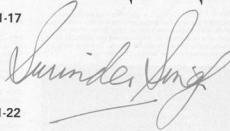

EDITOR:

P. Holmes

UK EDITORIAL STAFF

T. Day E. Rogans
 P. Williams

TECHNICAL EDITORIAL STAFF

J. Barendrecht
 G.H.K. Dam
 E. Krempelsauer
 G. Nachbar
 A. Nachtmann
 K.S.M. Walraven



a very special magazine for a very special price

Increasingly in demand, amongst
electronics hobbyists and professionals!

£ 6.50

elektor

A 1982 subscription delivered direct to your door
for £ 6.50 - saving £ 1.30 on the cover price.

That's what we call a real offer!

Complete the Elektor Readers Subscription and order card, and your cheque/P.O. for £ 6.50.
It's probably the best deal you'll make in 1981

Because of steadily increasing postal charges this offer can only apply to the U.K. Mainland. Subscriptions overseas
by post remain the same as last year! Even though the cover price and postage have increased.
We hope you all agree that this is fair to everyone.

P.S. If you live overseas and really can't wait to get your hands on Elektor
we will rush you a copy every month by airmail for £ 17.50.

Wherever you live don't forget to order your 1982 Binder.



for your copies of Elektor —

This cassette style binder will help to keep your copies of Elektor clean and in order, even though you refer to them time and time again. The chamfered corner of the cassette allows instant recognition of each month's issue without the need to thumb through pages of previous months' issues. Because no wires or fastenings are used copies can be easily removed and replaced and each cassette will hold one year's volume of Elektor. Their smart appearance will look good on any laboratory shelf.

PRICE £2.60 inc. postage & packing
available from —
Elektor Publishers Limited,
10 Longport,
Canterbury,
Kent CT1 1PE.
please use the order card
in this issue.

THE ELEKTOR CASSETTE BINDER

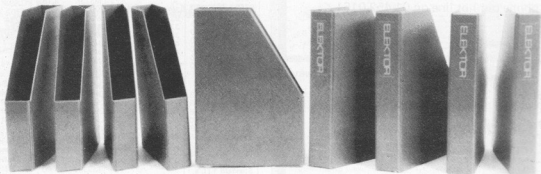

THE NEW "READY TO GO" SOLDERING IRONS

WITH
BUILT-IN
FINGER
PROTECTOR/GUIDE
AND FUSED
MAINS PLUG

A N T E X

Models XS-BP (25 watt) and CS-BP (17 watt) have moulded-on safety plugs, 'unbreakable' handles and detachable hook-cum-finger guide. High class insulation, with ceramic shafts inside stainless steel ones. Negligible leakage. A range of long-life iron and nickel plated bits, easily interchanged, slide on or off the shaft which enclose the heating elements for maximum efficiency of heat transfer. R.S.P. XS-BP and CS-BP 240v £5.30 + VAT. XS and CS without plug 240, 115, 50, 24 or 12 volt £4.50 + VAT. SEE THE NEW ANTEX SOLDERING IRONS AT YOUR LOCAL SUPPLIERS NOW!

ANTEX ELECTRONICS LTD.
Mayflower House, Armada Way, Plymouth, Devon PL1 1JX.
Telephone: (0752) 667377. Telex: 45296

ANTEX — THE 'HOT TIP' FOR SOLDERING

FROM CASSETTE TO VIDEO AND BACK

high-speed data transfer and the junior computer

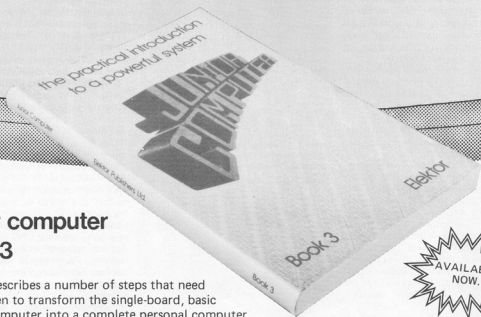

junior computer book 3

Book 3 describes a number of steps that need to be taken to transform the single-board, basic Junior Computer into a complete personal computer system. This involves adding an interface board to allow the machine to communicate with the outside world (its operator) in an 'adult' manner. The interface board provides additional I/O, a cassette interface, an RS 232 interface and an internal connection with the buffered bus board.

The hardware extensions complete the physical development of the computer and the sophisticated software in Book 4 enables the machine to fully utilise its additional memory capacity by extending its communication skills. As a result, a number of peripheral devices, such as a printer or a video terminal, can be 'hooked up' to the computer.

£ 4.75
ISBN 0905705 09 2



selektor

Electronic technology greatly benefits the disabled

The year 1981 was nominated the 'Year for the Disabled', a year in which large electronic companies certainly went to great lengths to introduce many new products for the handicapped. However, these developments are not only due to the special status attached to 1981. As soon as microelectronic technology paved the way for 'intelligent' aids, companies started taking an active interest in this field. If 1981 stands out as a milestone, it is only because the media published more material on the subject that year than in any other.

The present era has often been called the 'information age'. Information in all its forms and manifestations has indeed become increasingly important now that it can be 'distilled' into a tiny silicon chip. Not surprisingly, therefore, electronic industry is paying considerable attention to the disabled, who are physically deprived of the means to receive and provide information.

For a very long time, blind people had to resort to braille, a printing system that uses raised letters to enable texts to be read by touch.

Although the merits of the braille system should not be underestimated, it has great disadvantages as well. One volume of a complete dictionary in braille occupies about half a cubic metre. Furthermore, printing texts in braille requires special equipment which is not readily available to everyone. These considerations explain why not every text is able to be converted into braille and so be made accessible to the blind. This not only involves specialised technical papers, but also things sighted people take for granted, such as cartoons, etc., because whereas text can be converted into braille, illustrations can not.

Text is not however the only means of communicating visual information. We don't really realise how much information reaches us, day in, day out, in the form of warning lights, television pictures, street signs and a whole range of other visual data. These areas are usually completely outside the scope of braille and are a serious problem for visually handicapped people.

One of the most ambitious projects towards finding an alternative to braille resulted in an automatic reading device capable of converting written texts into speech. Such a system must include a portable camera to identify the individ-

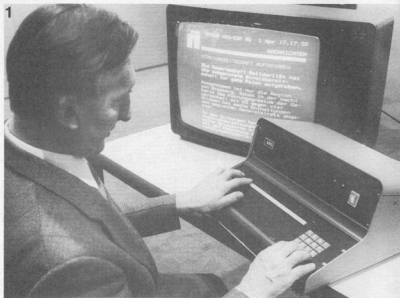

Figure 1. Teletext for the blind. An electronic system converts a page of teletext into braille which is scanned with the fingertips.



Figure 2. This professional level tube is especially designed for very myopic and blind persons and operates with an acoustic signal.



Figure 3. This electronic calculator enables the blind to benefit from modern technology by displaying the figures in braille.

ual letters of a text. The signals received from the camera are then processed by a speech synthesiser that is controlled by a microprocessor. Since Elektor has paid a great deal of attention to speech synthesis lately, most readers will be aware of the great progress that has been made in this field. Character recognition has also been studied for quite a while, with impressive results. The next step, the provision of good quality, low-cost text scanning speech synthesisers, will no doubt follow in the near future. Research is also being carried out to make television — including Teletext and Viewdata — accessible to the blind. AEG-Telefunken recently introduced a system which can make a line of teletext 'visible' as a row of 40 braille characters. Each character consists of a matrix of little rods that move individually. Just as a seven-segment LED can display any decimal number, this device is able to represent any braille character. The teletext code is fed into the device, so that the teletext page is read one line at a time.

In addition, research is being done on electronic displays. The Electronics Department of the Technical University at Delft (Holland) has taken the lead in this field. The electronic displays are based on the 'texture effect' principle. Different voltages at different places on

selektor

selektor

a display stimulate sense receptors in the skin of a person's fingertips. Eventually, it is hoped, this method will provide a low-cost tactile reading device, which will reproduce both films and photographs. Although a lot more work still needs to be done, the ultimate aim of the system is to allow the blind to partake in the growing data communication networks by way of the personal computer, viewdata, videophone, etc. In the meantime, the braille system will have to be electronically improved.

Automatic reading devices are fine for reproducing texts and the electronically scanned VDU adequately displays information on a screen, but they do not solve the numerous situations mentioned earlier, in which information is presented in a purely visual way, without the use of text or a screen. In such cases speech synthesis chips would be ideal for the visually handicapped. There are already a great many 'talking chips' on the market which can serve just about any purpose under the sun. AEG Telefunken, for instance, recently introduced a speaking thermometer. This enables blind persons to take their own temperature and find out indoor temperatures themselves. The device is a perfect illustration of how modern electronic technology can provide 'visual' information without the need for figures or letters.

Other examples include a speaking calculator, manufactured by Telesensory Systems Inc., and a speech module which can be incorporated into an elevator to indicate each floor that is reached and the direction in which the lift is travelling.

Speech synthesizers would also be a wonderful aid for people who are unable to speak and who have always had to resort to pen and paper or lip-reading to convey even very elementary messages. A portable, easy to operate speech synthesizer with an unlimited vocabulary would obviously be ideal. However, it will be quite a while before that ultimate goal can be attained.

Meanwhile, there are also people who are not only deprived of the powers of speech, but also have great difficulty expressing themselves in writing. One of the first developments to break through this barrier of silence, the 'communicator', was produced by Cannon, after an idea by two Dutch psychologists. The communicator consists of a miniature typewriter that can literally be worn on the wrist. The user has access to 26 keys for each letter of the alphabet and to another 26 auxiliary keys. The typed-in word is printed on a strip of paper, rather like a telex tape.

4



Figure 4. This thermometer expresses measurement values in synthetic speech. In addition to water temperatures body and room temperatures can be accurately recorded to a tenth of a degree in the 0° ... 60° C range.

5



Figure 5. The calculator for myopic operators reproduces figures that are four times the size of those shown on ordinary calculators.

6



Figure 6. This reading device will convert any text into braille.

For people who have trouble operating the communicator alphanumeric keyboard, the University of Wisconsin has designed a device called an 'Autocom'. This is a microprocessor controlled communication panel which can be installed on a wheelchair. The system has a great advantage in that various input and output devices can be con-

ted to it in a number of different combinations. One input possibility is an LED which acts as a running light above the various positions on the 'keyboard'. When the required position is reached, the corresponding switch only has to be depressed once for one of the 40 characters to be recognised. The standard output of the Autocom is a 32 character LED display and a printer (28 characters per line). In addition, the Autocom can be connected to a typewriter.

Speech synthesis research also led to new speech recognition systems, although developments are still at an early stage. Siemens have developed a car which can actually listen to commands given by its handicapped driver. The speech computer that it contains was manufactured by Konstanz, a Siemens associate company. The idea of a speech controlled car was conceived by Hans Kempf, who has suffered from polio ever since he was three years old. For the last twenty five years Kempf has been working on cars for the physically handicapped. The Siemens Renault 5 features a unit capable of recognising up to 350 commands, including 'close the door', 'turn the radio off', etc. This particular car was designed for drivers with missing upper limbs or who are unable to use them.

Again, a fair amount of work still needs to be done in the speech recognition

field. Nevertheless, several important steps have been taken in the right direction. One day, we hope, the marvels of modern electronics will not only enable the able-bodied to play space invaders, but will also allow the disabled to lead a normal life, surrounded by every possible communication facility.

The electronic chimes are constructed around the SAB 0600, which was designed to create a tuneful gong-like sound without the need for many additional components. The device is manufactured by Siemens, who have attempted to keep the current consumption and the external component count to a minimum. The typical quiescent current of the SAB 0600 is around $1 \mu\text{A}$, which means that if the circuit is powered from batteries they should last a relatively long time before having to be replaced. The only other components required for the basic version of the electronic chimes are one resistor, three capacitors and a small loudspeaker (see figure 1). This means that the entire circuit can be housed in a very small case.

proves both the sound and the volume. Another possibility is to fit the chimes with a switchable tone control so that the unit can be used in a straightforward paging system, as shown in figure 5. More about this later. To understand how these options can be put into practice it may well be a good idea to have a look at the 'insides' of the SAB 0600 first. Following that we will describe a number of 'application circuits' in which it can be used.

The 'contents' of the gong IC

The SAB 0600 is housed in an eight pin DIL package and the internal block diagram of the device is shown in figure 1. As can be seen, the majority

electronic chimes

doorbell with a difference

These chimes, the latest in the field of electronic doorbell/gong technology, produce a harmonious chord made up of three notes. The notes are 'played' in sequence and each note is 'held on' so that a triad is formed, which then decays slowly. The circuit is surprisingly versatile, considering its simplicity and low cost. Not only can it be used as a doorbell, but it could also be incorporated into paging systems for hospitals, offices, libraries etc.

If the device is to be used as a doorbell the existing system does not have to be modified in any way. This means, of course, that installation is very straightforward. However, the tone generator can be used for a number of other purposes as well: such as in intercom systems, in clocks, in the car as a warning device, in toys etc. All manner of sounds can be produced simply by altering the pitch.

The circuit diagram in figure 2 shows two gong ICs. The second has been added to improve the quality of the resultant tone. This is accomplished by slightly mistuning the fundamental frequency of one IC with respect to that of the other. This produces a tremolo effect which significantly im-

proves both the sound and the volume.

proved. The gong-like tone is produced by an RC oscillator which operates at a frequency of about 13.2 kHz with the component values shown. The oscillator signal is then divided to produce the three tone frequencies required by the gong chord. The three tone frequencies are approximately 440 Hz, 550 Hz and 660 Hz. By further dividing one of these frequencies, a control signal is obtained to time the 'melody'. This control signal determines both the duration of each tone and the eventual decay of the resulting triad.

Three digitally controlled attenuators (shown as D/A converters in the block diagram) control the amplitude of the

Technical data for the SAB 0600

supply voltage range	7...11 V
typical quiescent current consumption	$1 \mu\text{A}$
typical operational current consumption	160 mA
typical peak power output (after tone 3)	160 mW
trigger voltage range (at pin 1)	$1.5 \text{ V} \dots +U_b$
operational temperature range	$0 \dots 70^\circ\text{C}$

1

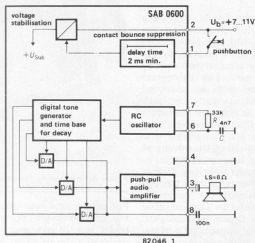

Figure 1. The internal block diagram of the SAB 0600. A tone sequence consisting of three harmonically tuned frequencies can be produced with a minimum of external components.

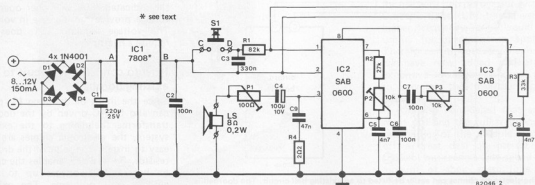

Figure 2. The complete circuit diagram of the electronic chimes. This 'luxury' version contains two gong ICs. As they are slightly mistuned with respect to each other, a slight tremolo and phasing effect is produced.

tone signals and ensure that they sound one after the other and blend in with each other before the start of the decay. A push-pull output stage provides about 160 mW when driving an 8 Ω loudspeaker. The volume produced is sufficient for the majority of applications. The output voltage of the IC is an almost symmetrical squarewave signal. The capacitor connected to pin 8 of the IC suppresses the harmonics in the output signal, as a result of which the tones sound far more pleasant than pure squarewave signals would. The volume may be further increased and the timbre improved by installing the loudspeaker in a suitable tube or box.

The tones are triggered by operating a pushbutton which links pin 1 of the IC to the positive supply voltage. A positive voltage of 1.5 V is sufficient to trigger the device. After about 2 milliseconds delay to suppress any contact bounce, the trigger pulse is fed to the voltage stabiliser circuit, which switches on the chimes. The voltage stabilisation is automatically switched off upon completion of the tone cycle. However, the tone sequence is repeated until such time as the pushbutton switch is released.

A word of warning when installing the system: long leads between the push-button switch and the circuit board may give rise to spurious triggering. This can be avoided by wiring a resistor in series with pin 1 and then connecting a capacitor to +U_B to decouple the control line.

Circuit diagram

A 'luxury' version of the chime circuit is shown in figure 2 and a printed circuit board design for it is illustrated in figure 3. Several components have been added to the basic circuit. The

3

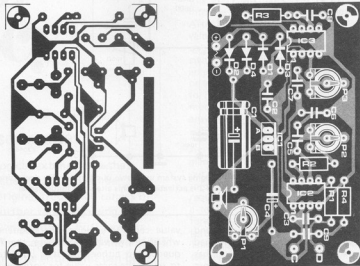

Figure 3. A suggested printed circuit board design for the electronic chimes.

Parts list

- Resistors:**
 R1 = 82 k
 R2 = 27 k
 R3 = 33 k
 R4 = 2Ω
 P1 = 100 Ω preset
 P2,P3 = 10 k preset

- Capacitors:**
 C1 = 220 µF/25 V
 C2,C6,C7 = 100 n
 C3 = 330 n
 C4 = 100 µF/10 V
 C5,C8 = 4n7
 C9 = 47 n

- Semiconductors:**
 D1... D4 = 1N4001
 IC1 = 7808(see text)
 IC2,IC3 = SAB 0600

- Miscellaneous:**
 LS = 8 Ω/0.2 W loudspeaker
 8... 12 V/150 mA transformer or 9 V battery (see text)

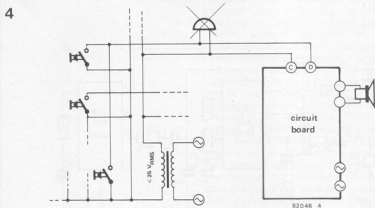

Figure 4. The electronic chimes can easily be fitted to an existing bell circuit. The doorbell is simply replaced by the chimes board. The latter is powered either by a 9 V battery or a small transformer.

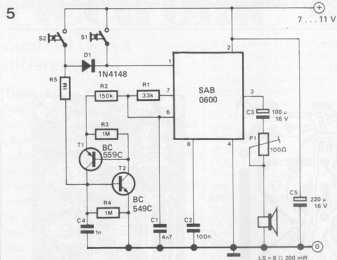

Figure 5. The circuit diagram of a simple paging system using two pushbuttons. By depressing S2 the additional circuitry around T1 and T2 is activated and this alters the fundamental frequency of the tones.

main addition being the second SAB 0600 for the reasons mentioned earlier. A voltage regulator circuit has also been added, which can be fed from a transformer having a secondary output voltage of 8...12 VAC. The circuit now consists of a 'double chime' in which the two ICs are connected in parallel, but operate a single loudspeaker by way of the output stage of the first device. Provided the two ICs do not differ by more than 3% in pitch, the resulting tremolo effect will be very satisfactory.

The output signal from IC3 is fed to the output stage of IC2 via preset potentiometer P3 and capacitor C7. This potentiometer is used to control the volume of the tremolo gong, IC3, whereas the volume of the entire circuit is controlled by potentiometer P1. To add resonance to the tremolo, the frequency of IC2 is slightly 'de-tuned' with respect to that of IC3 by means of P2. Capacitors C5 and C8 determine the fundamental frequency of the chime sound. High

value capacitors reduce the frequency, whereas low values increase the frequency. In either case, it is important to select the same value for both capacitors.

The 'vibrato luxury' described above need not be included, therefore IC3 and its associated components (R3, P3, C7 and C8) can simply be omitted. If required, P2 and R2 can be replaced by a 47 k preset potentiometer and 4k7 resistor respectively. This would give a much wider frequency adjustment range. The RC network, R4/C9, has been included to suppress RF oscillations in the output amplifier stages.

The circuit can be powered from a 'normal' doorbell transformer. However, current consumption is so low that it could also be powered from batteries. In the latter case, IC1, C2 and D4 can be omitted and diodes D2 and D3 can be replaced by wire links. After these changes, a 9 V battery can be connected between the points marked '+' and '-'. Diode D1 should be installed as this will

protect the circuit against incorrect polarity connection.

If a 12 V transformer is used, a 10 V regulator (7810) can be used instead of the indicated 7808. A higher operating voltage provides an increase in volume! The voltage regulator, IC1, does not require a heatsink.

How to connect the circuit to an existing doorbell

Since the input of the gong IC, pin 1, can also be AC driven by the doorbell transformer belonging to the existing system, the electronic chimes are very easy to install. The value of the dropper resistor, R1 (= 82 k), enables the circuit to handle AC voltages up to 25 V without any problems. The existing doorbell is removed and connection points C and D of the circuit are connected in its place (see figure 4). Now, however, the circuit can not be powered by the bell transformer. Either a 9 V battery or a separate miniature transformer with a secondary voltage of 8...12 V will have to be used. This transformer should be capable of supplying (briefly) at least 150 mA.

Paging system chimes

This particular type of circuit allows a number of pushbuttons to be combined with a single chime unit. A different frequency and decay speed are assigned to each pushbutton, so that a subtle distinction can be made between the various callers.

Figure 5 shows how this idea can be put into practice with the aid of two pushbutton switches. When switch S1 is depressed, the circuit is triggered in exactly the same way as described previously. Diode D1 decouples S1 from the second switch, S2. This prevents either switch being affected by the other. If, on the other hand, S2 is depressed, a change in frequency occurs with the aid of the circuit around transistors T1 and T2.

Together, these two transistors constitute a thyristor-like switching device. Switch S2 triggers the 'thyristor' at the gate on its cathode side (the base of T2), thereby causing the two transistors to conduct and the resistor R2 to be effectively connected in parallel to capacitor C1. This reduces the charge current to the capacitor and, as a result, the charge time is extended. Consequently, the fundamental frequency of the chimes is lowered and at the same time the decay of the tones is slowed down.

At the end of the tone sequence, the IC is automatically switched off, no current flows from pin 7, so that the hold current of the 'thyristor' is reduced and the thyristor stops conducting.

References:

Beitner, M.; Hauenstein, A.: "Triad gong using the SAB 0600 integrated circuit." *Siemens Components 19 (1981), No. 4.*

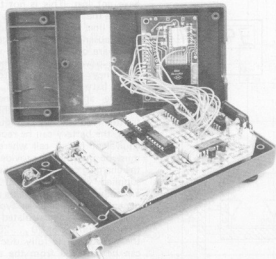

150 MHz frequency counter

with 26 programmable offset modes

The circuit described in this article is a logical extension to the hand-held LCD frequency counter published in the November 1981 issue of *Elektor* (page 11-18). The two original frequency ranges of 4 MHz and 35 MHz are retained, but a further range allowing a maximum count of 150 MHz has also been included. Furthermore, the circuit here utilises the frequency offset capabilities of the FM77T module to the full, in fact, all 26 of them. The entire unit can be housed in the same Vero case as before, resulting in a very useful and versatile hand-held frequency counter.

Table 1.

Specification for the 150 MHz frequency counter:

Frequency range 1:	2 kHz ... 3.999 MHz
input sensitivity:	30 mV
Frequency range 2:	100 kHz ... 39.999 MHz
input sensitivity:	< 450 mV
Frequency range 3:	10 MHz ... 150 MHz
input sensitivity:	10 mV
Maximum input voltage for ranges 1 and 2:	50 V _{rms}
Maximum input voltage for range 3:	7 V _{rms}
Input impedance for ranges 1 and 2:	1 M Ω
Input impedance for range 3:	50 Ω
Calibration:	none required
Power supply:	9 V battery or NiCad or external 8 ... 12 V a.c. power/charging source
Current consumption:	< 250 mA

The LCD frequency counter featured in the November 1981 issue is extremely accurate and very simple to construct. The maximum count of 35 MHz is ideal for use with microprocessor systems and Citizen's Band (CB) transceivers, but a higher frequency range would be very useful for many other applications. Therefore, with cost very much in mind, we have now added a relatively inexpensive divide-by-hundred prescaler to increase the maximum count to 150 MHz.

It was also considered that an instrument utilising the full frequency offset capabilities of the module would spark off a great deal of interest amongst those of our readers who spend a certain amount of their spare time working with the large variety of communications equipment currently available. The FM77T module not only includes the 4½ digit LCD display, but it is also possible to select any one of 26 pre-programmed standard IF offset values externally. This facility can be used, for instance, to display the received signal frequency by monitoring the frequency at the local oscillator of the receiver. The question was, how do we achieve all this and still manage to fit everything into the tiny hand-held instrument case? After all, the 26 selectable offset values and three frequency ranges totals up to a rather improbable 29-way switch. Even if this were readily available by some remote chance, it would be very unlikely to leave sufficient room for the printed circuit board and the module! This means that another answer had to be found.

Fingertip control

As readers who have already taken a glance at the circuit diagram will know, our design team arrived at a rather novel solution to the problem. The number of required switch 'positions' in fact reach a total of 32 and they are held, in the form of a 'program', in two PROMs (programmable read only memories). The address lines for these PROMs are selected via five pushbutton switches so that a specific 'data word' will be provided by the PROMs depending on the combination of switches depressed or not depressed. The data word from the PROMs is used for a number of purposes. Five of the PROM outputs are used to select the required frequency offset mode of the FM77T module and, as mentioned previously, there are a total of 26 offset modes.

Another three of the PROM outputs are used to select the particular range of the frequency counter. These ranges are 4 MHz and 35 MHz, as in the earlier version of the counter, and the new, higher range of 150 MHz. The decimal point positions are also determined by the 'program' outputs as are the kHz and MHz legends which appear on the display.

The block diagram

The block diagram of the 150 MHz

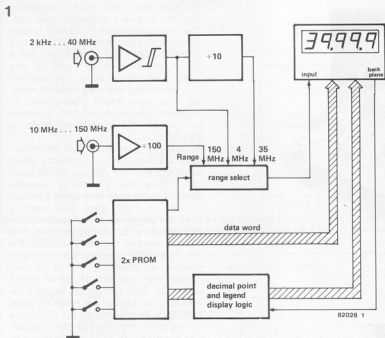

Figure 1. As can be seen from the block diagram, the complex switching has been greatly simplified by the novel use of PROMs.

counter is shown in figure 1. This should be fairly easy to understand, bearing in mind what was mentioned in the previous section. The input stages for the two lower frequency ranges are identical to those for the earlier LCD frequency counter and consist of an input amplifier followed by a divide-by-ten prescaler. The high frequency range input is fed directly to a divide-by-hundred prescaler. One of these three ranges is then selected by means of the 5 switches and the PROM outputs before being fed to the counter module. The code to select the particular frequency offset required is passed from the PROMs directly to the module. However, in order to make the decimal points and legends visible, they must first be modulated with the (inverted) backplane signal. This completes the discussion of the block diagram and we now move on to the circuit itself.

Circuit diagram

As can be seen from the circuit diagram in figure 2, the input stages of the two lower ranges, up to and including IC2, are identical to those of the original counter. Input A, the 'low' frequency input, is protected against excessively high voltages by diodes D1 and D2. The maximum voltage level that can be applied to this input is 50 V. Transistors T1 and T2 together form an 'impedance converter' and will convert the high input impedance (1 M Ω) to about 220 Ω for the amplifier N1. This amplifier is actually a TTL inverter, but it will still provide an analogue output

for small input voltage levels. The output voltage will be about 1.5...1.8 V peak-to-peak for an input voltage of 30 mV at C1. The amplified output signal is passed to the pulse shaper formed by inverters N2 and N3. This digital output is used for the lowest frequency range (20 Hz to 4 MHz) and is divided by ten in IC2 for the middle range (4 MHz to 35 MHz).

Input B, the 'high' frequency (150 MHz) input, is fed directly to IC1, a divide-by-hundred prescaler with a sensitive preamplifier. Only one of the three possible count outputs will be selected by the PROMs via the 'tri-state' buffers N4...N6.

The switching for the address lines of the two PROMs, IC3 and IC4, is carried out by means of the five pushbutton switches S1...S5. We will come back to the operation of these switches a little later. Five of the data output lines from IC3 are fed directly to the module. These are outputs 1y1...1y5 (pins 4...7 and 9) and they are used to select one of the 26 pre-programmable 1F offset frequencies within the module. The range selection is accomplished by means of the outputs 2y2...2y4 of IC4 (pins 5...7).

The decimal point and legend (kHz or MHz) data lines are not fed directly to the FM77T module since they must first be controlled with the inverted backplane signal in order to be made visible on the LCD display. This is accomplished by means of the four EX-OR gates N7...N10. Our sharp-eyed readers will have probably noticed

that the MHz legend signal appears to have got lost. This is not the case, in fact, as the MHz legend does not require a data line, it will appear automatically in the absence of the kHz legend.

There are options available with regard to the power supply for the 150 MHz frequency counter. An ordinary 9 V (PP3) battery can be used, which will provide approximately one hour of continual operation. In this instance resistor R28 will not be required. If desired, the battery can be replaced by an equivalent NiCad cell whereupon R28 must be included to provide a path for the charging current when the counter is supplied with an external 8...12 V a.c. source. The actual value of R28 will depend on the particular type of NiCad used and must be calculated to provide a charge current of 20...25 mA when the NiCad cell is fully discharged. As can be gathered from the above, it is also possible to power the circuit from a small 8...12 V transformer continually, in which case there is no need for either type of battery. Finally, another instance where no battery is required, the circuit can be powered from an external d.c. source, if available, of about 9 V/250 mA.

Program control

Manual operation of the frequency counter is carried out entirely by the five Digitast switches S1...S5 with the aid of table 2. This table shows the complete program for the two PROMs and its relationship with both the switching code and the module. In the column headed 'switching data' (left-hand side) S1...S5 refer to the actual switches. (This is not to be confused with the inputs, S1...S4, to the module in the output data column for IC3). A depressed switch is denoted by a '1'. It will be seen that for mode MO, none of the switches are depressed and in this situation the instrument will function as a straightforward 150 MHz frequency counter. This was chosen so that a 'hands off' reading would be a 'correct' reading, that is, without being over-range or having any offset.

The 35 MHz range is selected simply by holding switch S1, while the 4 MHz range will be selected if S2 is depressed. In this way, the frequency counter as such will be controlled by just the two buttons. The 26 possible 1F offset frequencies are shown in the far right-hand column of table 2.

A note about the three unused outputs of PROM IC4. While they serve no apparent function in the circuit of the counter as it stands, they are available and can be used for any purpose the constructor requires, provided, of course, that the PROM is programmed to provide the desired outputs. It should be noted that the PROM programmer featured in the Summer Circuits 1980 issue of *Elektor* (circuit number 97, page 7-90) can be used to program the 82S23 PROMs used here. The standard

2

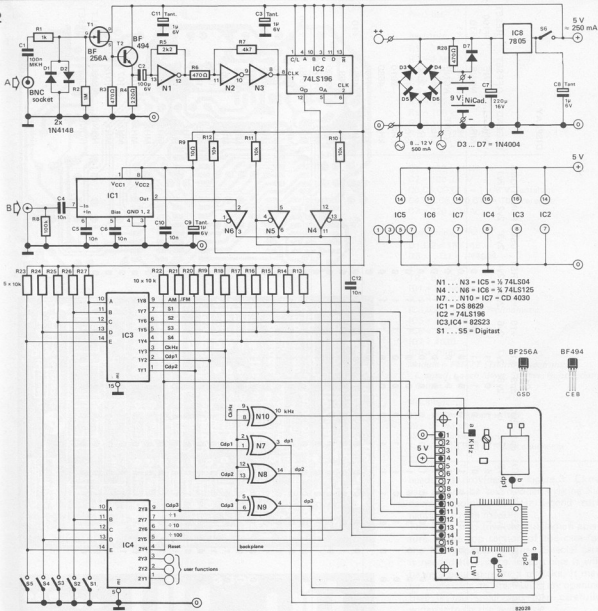

Figure 2. The complete circuit diagram for the 150 MHz frequency counter. The decimal point and legend connections to the module are shown in the illustration. These connections must be made with the utmost care or the module may be irreparably damaged.

3

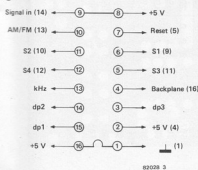

Figure 3. The wiring connections to the 'pin header' are shown here.

PROMs containing the program given in table 2 will be available from Technomatic Limited.

Construction

The completed frequency counter will have a very professional appearance if the Elektor printed circuit board and the hand-held Vero case (part number 65-2996H) are used. Since this case was designed for the FM77T module and the printed circuit board was designed to fit the case, construction should prove to be fairly straightforward. There are however, two minor details to be dealt with.

Trial and error using your own judgement will decide the actual fitting of

the completed printed circuit board. It should be mounted on three plastic spacers with the actual board approximately level with the top of the lower half of the case. In any event, it should be high enough to enable the switches to be operated when the top of the case is fitted, and low enough to just clear the underside of the module when the case is closed. It is not particularly critical and the board can even be mounted at a slight angle if necessary with a smaller gap at the display end of the case. It is as well to remember that a so called 'pin header' or DIL socket connector is used for making the connection between the FM77T module and the printed circuit board. A diagram giving the wiring details for the pin

Table 2.

SWITCHING DATA		PROGRAM BIT PATTERN										IC4										DISPLAY			
MODE	PROM ADDRESS	S5	S4	S3	S2	S1	S2	S3	S4	kHz	dp1	dp2	dp3	÷1	÷10	÷100	RST	USER FUNCTIONS				LEGEND	OFFSET	RESET	
M0	\$1F	0	0	0	0	0	1y8	1y7	1y6	1y5	1y4	1y3	1y2	1y1	2y8	2y7	2y6	2y5	2y4	2y3	2y2	2y1	MHz	NONE	÷100
M1	\$1E	0	0	0	0	1	D8	D0	1	1	0	1	1	0	0	1	1	0	1	0	1	0	MHz	NONE	÷10
M2	\$1D	0	0	0	1	0	9E	30	1	0	0	1	1	0	0	0	0	1	1	0	0	0	kHz	NONE	÷1
M3	\$1C	0	0	0	1	1	98	30	1	0	0	1	1	0	0	0	0	1	1	0	0	0	NONE	NONE	÷1
M4	\$1B	0	0	1	0	0	86	30	1	0	0	0	1	1	0	0	0	1	1	0	0	0	kHz	-4550	÷100
M5	\$1A	0	0	1	0	1	A6	30	1	0	0	0	1	1	0	0	0	1	1	0	0	0	kHz	-2600	÷100
M6	\$19	0	0	1	0	0	96	30	1	0	0	1	0	0	0	1	1	0	0	1	0	0	kHz	-4500	÷100
M7	\$18	0	0	1	1	0	B6	30	1	0	1	1	0	0	0	1	1	0	0	1	0	0	kHz	-2610	÷100
M8	\$17	0	1	0	0	0	8E	30	1	0	0	0	1	1	0	0	0	1	1	0	0	0	kHz	-4680	÷100
M9	\$16	0	1	0	0	1	AE	30	1	1	0	1	1	0	0	0	1	1	0	0	0	0	kHz	-4700	÷100
M10	\$15	0	1	0	1	0	C0	D0	1	1	0	0	0	0	0	1	1	0	0	1	0	0	MHz	-455	÷10
M11	\$14	0	1	0	1	1	E0	D0	1	1	0	0	0	0	0	1	0	0	1	0	0	0	MHz	-468	÷100
M12	\$13	0	1	1	0	0	D0	D0	1	1	0	1	0	0	0	0	1	1	0	0	1	0	MHz	-2000	÷100
M13	\$12	0	1	1	0	1	F0	D0	1	1	1	0	0	0	0	1	1	0	1	0	0	0	MHz	-10700	÷100
M14	\$11	0	1	1	0	0	01	60	0	0	0	0	0	0	0	1	1	0	0	0	0	0	MHz	+1070	÷100
M15	\$10	0	1	1	1	1	41	60	0	1	0	0	0	0	0	1	1	0	0	0	0	0	MHz	+1063	÷100
M16	\$0F	1	0	0	0	0	21	60	0	1	0	0	0	0	0	1	1	0	0	0	0	0	MHz	-1070	÷100
M17	\$0E	1	0	0	0	1	61	60	0	1	1	0	0	0	0	1	1	0	0	0	0	0	MHz	+1066	÷100
M18	\$0D	1	0	0	1	0	11	60	0	0	1	0	0	0	0	1	1	0	0	0	0	0	MHz	+1074	÷100
M19	\$0C	1	0	0	1	1	51	60	0	1	0	0	0	0	0	1	1	0	0	0	0	0	MHz	+1077	÷100
M20	\$0B	1	0	1	0	0	31	60	0	0	1	1	0	0	0	1	1	0	0	0	0	0	MHz	-1063	÷100
M21	\$0A	1	0	1	0	1	71	60	0	1	1	1	0	0	0	1	1	0	0	0	0	0	MHz	-1065	÷100
M22	\$09	1	0	1	0	0	09	60	0	0	0	0	0	0	0	1	1	0	0	0	0	0	MHz	-1066	÷100
M23	\$08	1	0	1	1	1	49	60	0	1	0	0	1	0	0	1	1	0	0	0	0	0	MHz	-1067	÷100
M24	\$07	1	1	0	0	0	29	60	0	0	0	1	0	0	0	1	1	0	0	0	0	0	MHz	-1068	÷100
M25	\$06	1	1	0	0	1	69	60	0	1	1	0	1	0	0	1	1	0	0	0	0	0	MHz	-1071	÷100
M26	\$05	1	1	0	1	0	19	60	0	0	0	1	1	0	0	1	1	0	0	0	0	0	MHz	-1074	÷100
M27	\$04	1	1	0	1	1	59	60	0	1	0	1	1	0	0	1	1	0	0	0	0	0	MHz	-1075	÷100
M28	\$03	1	1	1	0	0	39	60	0	1	1	1	0	0	0	1	1	0	0	0	0	0	MHz	-1077	÷100
M29	\$02	1	1	1	0	1	79	60	0	1	1	1	1	0	0	1	1	0	0	0	0	0	MHz	-1078	÷100
M30	\$01	1	1	1	1	0	98	70	1	0	0	1	1	0	0	1	1	0	0	1	1	0	NONE	NONE	HALT
M31	\$00	1	1	1	1	1	98	78	1	0	0	1	1	0	0	1	1	0	0	1	1	1	NONE	NONE	RESET

4

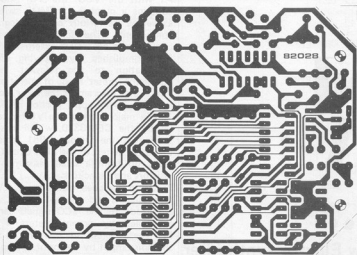

Parts list

Resistors:

R1 = 1 k
 R2 = 1 M
 R3, R6, R28 = 470 Ω
 R4 = 220 Ω
 R5 = 2k2
 R7 = 4k7
 R8 = 100 k
 R9 = 10 Ω
 R10 ... R27 = 10 k

Capacitors:

C1 = 100 n MKH
 C2 = 100 μ /6 V
 C3, C8, C9, C11 = 1 μ /6 V Tantalum
 C4 ... C6, C10, C12 = 10 n ceramic
 C7 = 220 μ /16 V

Semiconductors:

D1, D2 = 1N4148
 D3 ... D7 = 1N4004
 T1 = BF 256A
 T2 = BF 494
 IC1 = DS 8629
 IC2 = 74LS196
 IC3, IC4 = 82S23 (Technomic)
 IC5 = 74LS04
 IC6 = 74LS125
 IC7 = 4030
 IC8 = 7805

Module = FM77T (Thurby Electronics Limited, Coach Mews, St. Ives, Huntingdon, Cambs.)

Miscellaneous:

S1 ... S5 = Digitast switch
 S6 = SP switch
 2x BNC socket
 Battery type PP3 or NiCad equivalent

header is provided in figure 3. Extra care should be taken when making the decimal point and kHz legend connections to the module.

The next step involves cutting an aperture in the top section of the case for the five Digitast switches. Special care is needed here since in this case it will be very easy to make a mistake. It may be preferable to start with an opening that is too small and then carefully widen it to fit the switches.

The on/off switch, S6, can be a miniature toggle switch as shown in the heading photograph. Again, care is needed since space is limited. Judicious use of good quality insulating tape may well help to overcome a few space problems! The two BNC sockets can be mounted next and these connections are the only ones that require soldering to be carried out inside the case. Finally, a miniature socket for the external A.C. power source can be mounted next to the battery.

It is important to ensure that no connecting wires can be trapped between the two halves of the case when they are fitted together. If you are satisfied that everything is correct, a suitable power source can be connected and the operation of the frequency counter can be tested. As there is no calibration requirement the reading will be correct right from the start.

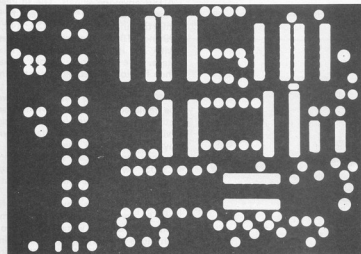
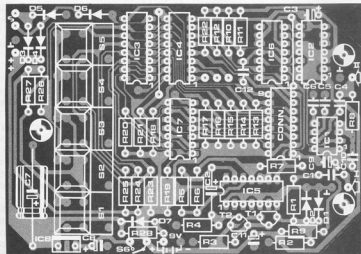

Figure 4. The printed circuit board track pattern and component layout for the 'earth plane' on top of the board. Through plating is not required.

combined VCF/VCA module...

... for the new Elektor synthesiser

The VCO module described in the December issue of Elektor by no means provides a complete synthesiser. Connection to at least one voltage controlled amplifier (VCA) and a voltage controlled filter (VCF) is required to obtain a simple, playable instrument. A very compact 24 dB/octave low pass filter can be constructed around the Curtis integrated circuit type CEM 3320. With the aid of this device two VCAs (using the already established Formant circuitry) can be accommodated on the same printed circuit board.

The voltage controlled filter

As with the VCO, the VCF module contains a number of CMOS switches as well as the various 'active' integrated components. The former enable the circuit to be controlled externally. This is accomplished by applying digital information to the relevant inputs during the 'preset' mode of operation. The circuit diagram of the filter section is shown in the upper portion of figure 1. The major part of the VCF is taken up by the CEM 3320, which was described in the October 1981 issue of Elektor. The rest of the filter circuitry is made up from a small assortment of resistors and capacitors.

Provision has been made for two VCO input signals and one noise input. The amplitude of the VCO signals can be controlled by potentiometers P1 and P2. These signals are then mixed with the noise input by means of opamp A1. The resultant signal is then fed to the input of the filter IC. (The potentiometer used to adjust the amplitude of the noise signal is situated on the front panel of the NOISE/LFO module. This module will be described in a future issue of Elektor.)

The resonance (Q factor) of the low pass filter is determined by a control voltage derived from potentiometer P4 and is fed to pin 9 of IC1 via the CMOS switch S1 (pins 8 and 9 of IC3). This parameter can also be affected by an external control voltage applied via S2 (pins 10 and 11 of IC3). As with the VCO module, S1 has to be temporarily replaced by a wire link until such time as the complementary control circuits are published.

The cut-off frequency of the filter is determined by a number of factors: coarse and fine adjustment by means of potentiometer P3 and preset P7, respectively; the keyboard output voltage, KOV (tracking filter); and the LFO and ADSR envelope signals. The sources of these voltages are connected to the inverting input of A3 via R23, R42, P8, P9 and P10. These components, together with A3 itself, form a simple mixing stage. The combined output signal is then fed to the frequency control input (pin 12) of the filter IC.

CMOS switches S4 and S6 also have to be replaced by wire links temporarily, otherwise the envelope control signal (via P5) and the control voltage provided by P3 cannot be used. External frequency control can be provided via CMOS switch S3. If this facility is required then the wire link must be moved from the S4 position to S3. The amplitude of the envelope waveform can be varied between zero and maximum by a control voltage applied to the 'envelope amplitude program' input (connection point 10 in the circuit diagram), provided S5 is closed and S6 is open.

The waveform at the 'envelope' input (point 8) is not only connected to potentiometer P5, but also to the signal

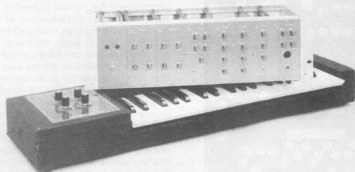

The new synthesiser poses with the Formant keyboard.

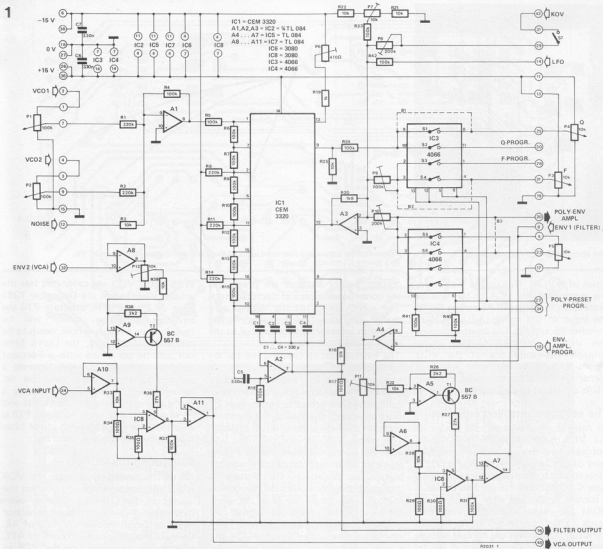

Figure 1. The complete circuit diagram of the combined VCF/VCA module. The Curtis IC (CEM 3320) contains just about all that is required to construct a voltage controlled 24 dB/octave low pass filter.

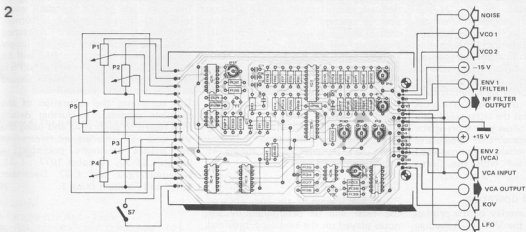
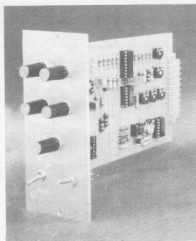

Figure 2. The external connections to the VCF/VCA module printed circuit board.



The completed VCF/VCA module.

input of a VCA. This means that either the output of the VCA or the voltage present on the wiper of P5 can be fed to the input of the mixer (A3) via CMOS switches S5 and S6. The construction of this VCA is identical to that which controls the amplitude of the VCO signals (shown in the lower left-hand corner of figure 1), the details of the VCAs are about to be described.

The voltage controlled amplifier

As mentioned previously, the design of the VCA is based on the well-proven Formant circuitry. The central component of the amplifier is a so-called OTA (operational transconductance amplifier) type CA 3080. Effectively, this device is a current controlled amplifier. As both VCAs are virtually identical, only one needs to be described. Opamp A5 and transistor T1 convert the control voltage into a control current, which is fed to pin 5 of the OTA via resistor R27. Opamps A8, A10 and A11 serve as buffers. The input signal is attenuated by the voltage divider network R28/R29 down to a level that the OTA can handle. The output of the OTA is buffered by the voltage follower A7 before being fed to the mixer A3. The OTA VCA is constructed separately from and its operation does not depend on the VCF. The circuit is very easy to construct, is very inexpensive and, above all, it performs very well. It has a major advantage over the Curtis VCA (CEM 3330) in that the latter was found to be unable to follow very short attack times. This means that percussive sounds (piano, cymbals, xylophone, etc.) cannot be realised with the Curtis device.

Calibration and operation

The component overlay of the printed circuit board for the VCF/VCA module is shown in figure 2. The various sections of the module are tested separately. After installing the wire links B1... B3 instead of IC3 and IC4, check that the

3

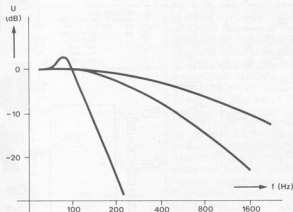

82031 3

Figure 3. The frequency characteristics of the filter for different settings of P4.

correct supply voltages are present at the corresponding pins of the IC sockets. The audio output of the voltage controlled oscillator (low frequency range, sawtooth waveform) is connected to the input of the filter (P1 or P2).

The module can be checked 'by ear' by connecting an audio amplifier to the output of the filter. Potentiometers P3 and P4 are turned fully anti-clockwise. Following this, preset potentiometer P7 is adjusted until the level of the sawtooth signal at the filter output is just audible. The centre frequency of the filter will now be in the sub-sonic range. Potentiometer P3 is used to vary the control voltage in stages; as the voltage is increased the harmonics of the fundamental filter frequency plus the overtones of the sawtooth signal are produced. When P3 is turned fully clockwise, the upper threshold for the cut-off frequency of the filter can be set by means of preset potentiometer P9. Again, the easiest way to adjust this parameter is 'by ear'. Potentiometer P4 is then turned fully clockwise. The frequency characteristic of the filter becomes visibly steeper until a resonance peak is reached (see figure 3). If the control voltage is increased still further, the filter will tend to oscillate: at a certain point the frequency of oscillation will coincide with the centre frequency of the filter. Preset potentiometer P9 is then adjusted so that the frequency of these oscillations is so high when P3 is fully turned up, that they are just beyond the human hearing range. Then the entire tone frequency range can be covered by means of potentiometer P3.

Calibration of P8

By closing switch S7 the frequency of the filter will be determined by the notes played on the keyboard, provided P8 is correctly calibrated. Adjust P3 until the filter starts to oscillate, in other words, it acts like a VCO. Now calibrate P8 in exactly the same manner

as P5 of the VCO was calibrated (see the article published in the December 1981 issue of Elektor). To calibrate P10 the envelope generator, which will be described in a future article, needs to be connected. Obviously, the Curtis filter can also be combined with a Formant envelope generator. In this instance a sustain value of 100% must be set before adjusting P10. By depressing a key, turning P3 fully anti-clockwise and P4 until the filter starts oscillate, P10 is adjusted until the frequency of the filter is just inaudible to the human ear.

Calibrating the VCA

All that is needed to calibrate the VCA is a single potentiometer to prevent the input to the OTA from being overmodulated. Again an envelope generator needs to be connected to pin 3 of A8. Connect an oscilloscope to pin 8 of A11. Link the audio output of the VCF to the audio input of the VCA. Connect a sawtooth signal to the filter input and turn P1 and P3 fully clockwise. Adjust preset potentiometer P12 slowly from its minimum to its maximum setting. The amplitude of the sawtooth waveform will increase as P12 is turned. Eventually a certain point is reached where the amplitude will no longer increase. When this occurs P12 will be correctly calibrated. The setting of P6 is not quite so critical: the wiper should be set in the centre position!

This completes the calibration of the complete module. For further details with regard to calibrating and using the VCF and VCA, readers are referred to the articles previously published in Elektor (E-30, October 1977; E-31, November 1977 and E-32, December 1977) and Formant Book 1. ✠

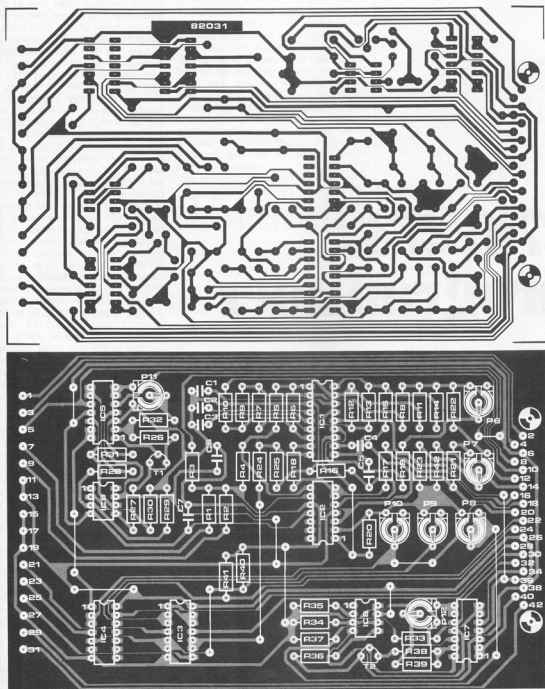

Figure 4. The track pattern and component overlay for the VCF/VCA module printed circuit board.

Parts list

Resistors:	R18 = 51 k
R1, R2, R8, R11, R14 = 220 k	R19 = 1 k
R3, R21, R22, R25, R28, R32, R33, R39 = 10 k	R20 = 1k8
R4 . . . R7, R9, R10, R12, R13, R15, R16, R23, R24, R31, R37, R40 . . . R42 = 100 k	R26, R38 = 2k2
R17, R29, R30, R34, R35 = 100 Ω	R27, R36 = 27 k
	(R5 . . . R15 = 1% metal film)
	P1, P2 = 100 k log
	P3 . . . P5 = 10 k lin
	P6 = 470 Ω preset
	P7, P11, P12 = 10 k preset
	P8 . . . P10 = 200 (220, 250) k preset

Capacitors:

C1 . . . C4 = 330 p
C5 . . . C7 = 330 n

Semiconductors:

T1, T2 = BC 557B
IC1 = CEM 3320
IC2, IC5, IC7 = TL 084
IC3, IC4 = 4066 (not yet required)
IC6, IC8 = 3080

P.R. Boldt

There are a number of differences between the programmer published in the October 1981 issue and the circuit featured here. The earlier 'plug-in' programmer can only be used to program 2716 devices and the microprocessor system used has to have a 'hold' facility. This latter means that it can not be used with the Junior Computer. The latest circuit can be used to program both 2716 and 2732 devices and has been designed specifically for use with the SC/MP and Junior Computer systems, although it can probably be used in other systems as well. A standard connector can be mounted on the printed circuit board for the new pro-

The circuit diagram

Before having a closer look at the programming, it is a good idea to examine the intricacies of the circuit itself (see figure 1). As stated previously, the address and data information has to be temporarily stored in latches. This is accomplished by means of IC1...IC4. The 2716 requires 11 address lines, whereas the 2732 requires 12. The twelfth address line (A11) is connected to the 2732 via switch S1 (the 2716/2732 selector switch).

The data lines, D0...D7, are fed to two latches connected in parallel (IC1 and IC2). The inputs of IC1 are connected to the outputs of IC2 and vice versa. Consequently, it is possible for the computer to read the data contained in the EPROM being programmed. As can be seen from the left-hand side of the diagram, a few other connections to the computer are also required.

Furthermore, some form of address decoding has to be provided, so that the EPROM can be programmed from any area of computer memory. 'Page addressing' is accomplished by means of a four bit comparator, IC5. The 'A' inputs of this device are connected directly to the high order address lines A12...A15, whereas the 'B' inputs are connected to switches S3...S6. An 'open' switch produces a high logic level, therefore S3 corresponds to address line A12, S4 to A13, S5 to A14 and S6 to A15. A so called 'page' always consists of 4 kilobytes. This may seem quite a lot, but it is essential as the circuit has to be able to program and read (verify) a 4k EPROM (2732). This means that when a 2716 is programmed it can be accessed in two address ranges — $x000...x7FF$ and $x800...xFFF$, where x is any hexadecimal value (0...F) depending on the positions of S3...S6.

The timing for the programming pulses is derived from IC6, which is a CMOS version of the well known 555 timer and which is connected as an astable multivibrator. The values of capacitor C1 and resistors R5...R7 determine the pulse duration of the multivibrator. With the values shown, this pulse duration is 10 ms. The output of the multivibrator is fed to the input of an 8 bit shift register, IC7, via an inverter, N5. The reset input of IC6 (pin 4) is fed from the Q output of flipflop FF2. The clock inputs of flipflops FF1 and FF2 are provided with clock pulses via inverter N6, which is connected to pin 31a of the 'bus' connector. Consequently, both flipflops receive a clock pulse each time the processor outputs a write signal.

The 'A=B' output of IC5 will become high as soon as the preset page address is recognised. If the flipflops receive a write pulse from the processor at this time, the Q outputs of both FF1 and FF2 will go high simultaneously. FF2 removes the reset from the multivibrator (IC6), thereby starting the timing se-

2716/2732 programmer

EPROM programmers are available in all shapes and sizes. The larger, more complicated machines tend to be rather expensive. However, a simple one can be constructed if the owner's microprocessor system is made to do the majority of the work, as we proved in the October 1981 issue of Elektor. The EPROM programmer described here is somewhat 'middle of the road' in that it has been designed specifically for use with the Elektor SC/MP and Junior Computer systems. It is very compact (all the components can be mounted on a single 'Eurocard' board) and it can be used to program 2732 devices as well as the popular 2716s. Also, it is possible to verify that the programmed data is correct.

grammer which will mate directly with the SC/MP data bus or the Junior Computer expansion connector. These reasons seem sufficient grounds for publishing the new design.

A detailed description of how the 2716 EPROM can be programmed was given in the previous article (October 1981, page 10-14), therefore only a brief description is required here. Just to refresh your memory, a programming voltage of 25 V has to be connected to the V_{pp} input of the device in question. As far as the 2716 is concerned, this is pin 21, but in the case of the 2732, it is pin 20. Also, a programming pulse with a duration of at least 50 ms has to be applied to the CE input (pin 18) of the EPROM so that the information present on the data lines can be stored in the corresponding address location.

If you have a computer which has a 'hold' facility at your disposal, then the 'plug-in EPROM programmer' will be quite sufficient. However, it can not be used with the Junior Computer, as there is no facility for holding the address and data lines stable for the 50 ms period required for programming. This means that for the idea to be implemented on the Junior Computer, the information presented to the address and data lines has to be 'latched' until programming is completed. Although these latches are not required by the SC/MP, they are included on the printed circuit board to make the unit more 'versatile'. The board can be 'programmed' for use with either the SC/MP or the 6502 (Junior Computer) by means of wire links. The circuit is designed in such a way that all the signals required during the programming are generated by means of hardware.

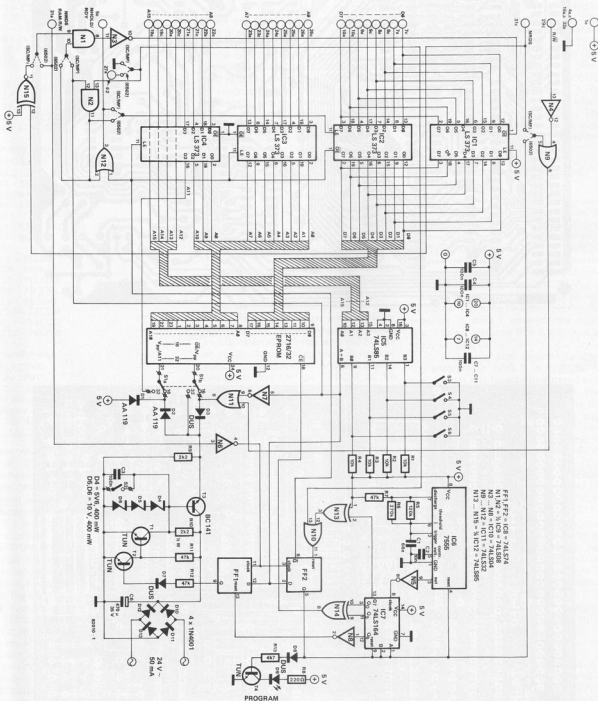

Figure 1. The complete circuit diagram of the 2716/2732 EPROM programmer. The EPROM to be programmed is shown at the centre of the diagram with the latches to the left and the 25 V supply and timing circuitry to the right.

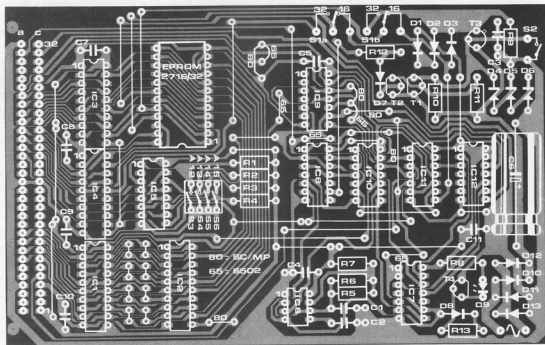
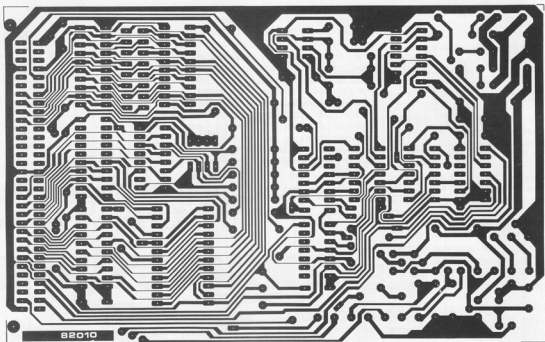

Figure 2. The printed circuit board and component overlay for the programmer.

Parts List

Resistors:

R1...R4 = 10 k
 R5 = 120 k
 R6 = 270 k
 R7,R11,R12 = 47 k
 R8 = 220 Ω
 R9 = 2k2
 R10 = 2k2/1/2 W
 R13 = 4k7

Capacitors:

C1 = 68 n
 C2 = 10 n
 C3...C5,C7...C11 = 100 n
 C6 = 470 μ /35 V

Semiconductors:

D1,D2 = AA 119
 D3,D7,D8 = DUS
 D4 = 5V6/400 mW zener diode
 D5,D6 = 10 V/400 mW zener diode
 D9 = LED
 D10...D13 = 1N4001
 T1,T2,T4 = TUN
 T3 = BC 141
 IC1...IC4 = 74LS373
 IC5 = 74LS85
 IC6 = 7555
 IC7 = 74LS164
 IC8 = 74LS74
 IC9 = 74LS08
 IC10 = 74LS04
 IC11 = 74LS32
 IC12 = 74LS86

Miscellaneous:

S1 = DPST
 S2 = SPST
 S3...S6 = 4 miniature DIL switches
 24 pin zero insertion socket
 64 pin right-angle male connector,
 DIN 41612

quency, FF1, on the other hand, enables the small power supply constructed around transistors T1...T3 to provide the required 25V for the programming input of the EPROM. The 25V power supply can be switched on and off via FF1 or, alternatively, it can be disabled by means of switch S2 so that the EPROM can only be 'read'.

Now to continue the story; the programming voltage is switched on and the timer has been started. The trailing edge of the pulses supplied by the timer enter a succession of 'ones' into the shift register, IC7. This means that the Q₀ output of the shift register becomes high after 10 ms, and so does the CE input of the EPROM. The CE input remains high for a duration of 50 ms, due to the fact that the Q₀ and Q₅ outputs of the shift register are gated together by means of the EXNOR gate N14. After a further delay of 10 ms, output Q₆ will go high, which resets flipflop FF1 and turns off the programming voltage. During this time the latches are enabled via the Q output of FF2 until the Q₇ output of IC7 goes high 10 ms later. The Q output of FF2 is also connected to transistor T4 via D8 and R13. This transistor turns on

LED D9 all the time that the EPROM is being programmed.

The section of the circuit just described has nothing to do when the contents of the EPROM are being read — as the processor does not provide a write signal at this time. During the read process the outputs of IC2 are set in the 'tri-state' mode and IC1 is enabled, which means that the information contained in the EPROM is (almost) connected directly to the data lines of the processor.

Switch S1 is used to select between the two possible types of EPROM that can be programmed. If S1 is in the position indicated in the diagram (2716), the programming voltage is connected to pin 21 via diode D2 and the OE input is connected to the output of gate N11. With the switch in the other position (2732), address line A11 is connected to pin 21 and the programming voltage is applied to pin 20. Various control signals for the programmer are derived from those of the microprocessor via gates N1...N4, N9, N10, N12 and N15.

The printed circuit board

The printed circuit board and component overlay for the EPROM programmer is given in figure 2. Mounting the components onto the Eurocard sized board should not cause any problems, especially for readers who have gained construction experience with the SC/MP or Junior Computer systems. A word of advice: it is important to select a good quality socket for the EPROM as this has to be used repeatedly. Ideally, a 'zero insertion force' type should be used.

Depending on whether the programmer board is to be used with the SC/MP system or with the Junior Computer, certain wire links will have to be installed. These are clearly marked on the component side of the board. All other connections are made via the standard 'bus' connector. The only component not mounted on the board is the 24V transformer which is required for the programming voltage supply.

Using the programmer with the SC/MP

It is a very simple matter to use the EPROM programmer with the Elektor SC/MP system. The first requirement is to close switch S2. When the desired address range has been set by means of switches S3...S6, an 'empty' EPROM is mounted in the socket and the board installed into the system. After the 24V a.c. voltage has been applied, switch S2 is opened and the power supply to the computer turned on. Now the EPROM can be programmed. It is wise to close S2 as soon as programming has been completed.

The SC/MP system does not require any extra software for programming EPROMs. ELBUG is quite sufficient. Memory locations can be programmed

by using the 'modify' key followed by the address of the location to be programmed (Mo...YYYY). An unprogrammed EPROM location will indicate 'FF' on the display. If, for example, the value 08 is to be stored at the chosen location, all that has to be done is to enter 08 and the data will be stored in the specified address location.

If larger data blocks are to be programmed, it is recommended to store them somewhere in RAM first. They can then be transferred to EPROM via the block transfer routine (BL...SSSS, EEEE, BBBB; where S = start address, E = end address and B = initial address of where the data block is to be located). The EPROM can be read in exactly the same manner as for a 'normal' memory location.

Using the programmer with the Junior Computer

Beyond the Junior Computer can be used to program EPROMs, a short 'piece' of software is required. A suitable program is given in table 1. This is stored in locations 0200...0277. The EPROM programmer card has to be connected to the expansion connector of the Junior Computer before the 24V a.c. voltage is applied. Finally, the Junior Computer has to be switched on and the program in table 1 entered into memory. The programmer board will then be ready for use.

It is, of course, now possible to store the program in table 1 in EPROM, so that it does not have to be entered each time it is required. This means that the absolute jump instructions in the program have to be altered so that the routines will work correctly in a different memory area. It is possible to 'store' the program in the TM EPROM situated on the extension board. This still has a number of empty locations, 0C80...0CFF, which can be used for exactly this purpose (in the EPROM itself these are locations 480...7FF). If the TM EPROM is to be used to store the 'program' program the start address should be 0C80 instead of 0200 (see table 1) and the absolute jump instructions (all three byte instructions ending with the value 02) should be modified accordingly. We will now give a brief description of the three program sections: Program, Duplicate and Verify.

The program routine

The low and high order bytes of the EPROM start address are first stored in memory locations MOVH and MOVH (0004 and 0005), respectively. Then the program routine is started from address 0200. Now the address and the data contained therein will appear on the Junior Computer display.

If, for example, the value A9 is to be programmed into the specified location, the key 'A' is depressed (the display remains unchanged) followed by key-9. The display will then go blank for a

```

0010: 0200          ORG  $0200
0020:
0030:          DATE : 10-7-'81
0040:
0050:
0060:          PAGE ZERO DATA BUFFERS :
0070:
0080: 0200          SAL  *   $0000  DATA BLOCK START ADDRESS
0090: 0200          SAH  *   $0001
0100: 0200          EAL  *   $0002  DATA BLOCK END ADDRESS + 1
0110: 0200          EAH  *   $0003
0120: 0200          MOVL *   $0004  EPROM PROGRAM START ADDRESS
0130: 0200          MOVH *   $0005
0140:
0150: 0200          INH  *   $00F9  DISPLAY BUFFER ( DATA )
0160: 0200          POINTL * $00FA  " " ( ADDRESS L )
0170: 0200          POINTH * $00FB  " " ( ADDRESS H )
0180:
0190:          EXTERNAL SUBROUTINES :
0200:
0210: 0200          GETBYT * $1D6F
0220: 0200          SCAND * $1D88
0230:
0240:          JUNIOR MONITOR START :
0250:
0260: 0200          RESET * $1C1D
0270:
0280:
0290:          PROGRAM START ADDRESS : $0200 ( PROG )
0300:          DUPLICATE START ADDRESS : $0222 ( DUPL )
0310:          VERIFY START ADDRESS : $0233 ( VERIFY )
0320:
0330:
0340:          *****
0350:          EPROM-PROGRAMMER
0360:          *****
0370:
0380: 0200 20 55 02  PROG  JSR  TRF  TRANSFER MOVL(H) TO POINTL(H)
0390: 0203 A0 00  PRGR  LDYIM $00  CLEAR Y-REGISTER
0400: 0205 B1 FA          LDAYI POINTL  GET DATA SPECIFIED BY POINTL(H) AND
0410: 0207 85 F9          STAZ  INH  STORE THIS IN DISPLAY BUFFER INH
0420: 0209 20 6F 1D  JSR  GETBYT  READ TWO HEXKEYS AND STORE THEIR VALUE IN THE
0430:          ACCUMULATOR. RETURN WITH N=1 IF
0440:          ONLY HEXKEYS WERE DEPRESSED.
0450:          IF A COMMAND KEY WAS DEPRESSED,
0460:          RETURN WITH N=0
0470: 020C 10 07          BPL  PR  COMMAND KEY DEPRESSED?
0480: 020E A0 00  LDYIM $00  CLEAR Y-REGISTER
0490: 0210 91 FA          STAYI POINTL  PROGRAM THE CONTENTS OF THE ACCUMULATOR IN
0500:          THE EPROM MEMORY LOCATION
0510:          SPECIFIED BY POINTL(H)
0520: 0212 4C 03 02          JMP  PRGR
0530: 0215 C9 12  PR  CMPIM $12
0540: 0217 D0 35          BNE  PRGR  +KEY?
0550: 0219 E6 FA          INCZ POINTL  INCREMENT ADDRESS BY ONE
0560: 021B D0 E6          BNE  PRGR
0570: 021D E6 FB          INCZ POINTH
0580: 021F 4C 03 02  JMP  PRGR
0010: 0222 20 55 02  DUPL  JSR  TRF  TRANSFER MOVL(H) TO POINTL(H)
0020: 0225 A0 00  DU  LDYIM $00
0030: 0227 B1 00          LDAYI SAL  GET DATA SPECIFIED BY SAL(H)
0040: 0229 91 FA          STAYI POINTL  PROGRAM THE CONTENTS OF THE ACCUMULATOR IN
0050:          THE EPROM MEMORY LOCATION
0060:          SPECIFIED BY POINTL(H)
0070: 022B 20 5E 02          JSR  INCMNT  INCREMENT SAL(H) AND POINTL(H) BY ONE
0080: 022E D0 F5          BNE  DU  NOT LAST ADDRESS
0090: 0230 4C 1D 1C  JMP  RESET  RETURN TO JUNIOR MONITOR
0100:
0110: 0233 20 55 02  VERIFY JSR  TRF  TRANSFER MOVL(H) TO POINTL(H)
0120: 0236 A0 00  VER  LDYIM $00
0130: 0238 B1 FA          LDAYI POINTL  GET DATA SPECIFIED BY POINTL(H)
0140: 023A D1 00          CMPIY SAL  COMPARE THIS DATA WITH DATA SPECIFIED BY SAL(H)
0150: 023C F0 0F          BEQ  NEXT  DATA EQUAL?
0160: 023E 20 88 1D  ANYKEY JSR  SCAND  DISPLAY EPROM ADDRESS AND DATA

```



```

0170: 0241 D0 FB      BNE  ANYKEY  ANY KEY DEPRESSED?
0180: 0243 20 88 1D   JSR  SCAND   DISPLAY EPROM ADDRESS AND DATA
0190: 0246 D0 F6      BNE  ANYKEY  ANY KEY DEPRESSED?
0200: 0248 20 88 1D   JSR  SCAND   DISPLAY EPROM ADDRESS AND DATA
0210: 024B F0 FB      BEQ  NKEY    NO KEY DEPRESSED?
0220: 024D 20 5E 02  NEXT JSR  INCMNT  INCREMENT SAL(H) AND POINTL(H) BY ONE
0230: 0250 D0 E4      BNE  VER    NOT LAST ADDRESS?
0240: 0252 4C 1D 1C   JMP  RESET  RETURN TO JUNIOR MONITOR
0250:
0260: *****
0270:                SUBROUTINES
0280:                *****
0290:
0300: 0255 A5 04      TRF  LDAZ   MOVL
0310: 0257 85 FA      STAZ  POINTL  TRANSFER MOVL TO POINTL
0320: 0259 A5 05      LDAZ  MOVH
0330: 025B 85 FB      STAZ  POINTH  TRANSFER MOVH TO POINTH
0340: 025D 60      RTS
0350:
0360: 025E 20 88 1D   INCMNT JSR  SCAND   DISPLAY FOR ABOUT 5MS POINTH, POINTL
0370:                                AND INH ( = EPROM ADDRESS AND DATA
0380:                                ON THIS ADDRESS )
0390: 0261 E6 00      INCZ  SAL    INCREMENT SAL(H) BY ONE
0400: 0263 D0 02      BNE  INCDA
0410: 0265 E6 01      INCZ  SAH
0420: 0267 E6 FA      INCDA INCZ  POINTL  INCREMENT POINTL(H) BY ONE
0430: 0269 D0 02      BNE  COMP
0440: 026B E6 FB      INCZ  POINTH
0450: 026D A5 01      COMP  LDAZ   SAH
0460: 026F C5 03      CMPZ  EAH   COMPARE EAH WITH SAH
0470: 0271 D0 04      BNE  RTRN  EAH NOT EQUAL SAH?
0480: 0273 A5 00      LDAZ  SAL
0490: 0275 C5 02      CMPZ  EAL   COMPARE EAL WITH SAL
0500: 0277 60      RTRN  RTS

```

Table 1. The software required for the Junior Computer to program and verify EPROMs.

short while (about 70 ms) and then the value A9 will appear to indicate that the EPROM location has been programmed correctly.

The next address will appear after the '+' key has been operated. New data can then be programmed into this location. The contents of the EPROM can be read by simply depressing the '+' key repeatedly, or by returning to the monitor program of the Junior Computer (depress the reset key).

The duplicate routine

This routine is used to copy a section of memory from one area to another. In order to do this, the memory locations SAL and SAH (0000 and 0001) have to contain the start address of the data block which has to be copied; EAL and EAH (0002 and 0003) have to contain the end address +1 of the data block to

be copied; MOVL and MOVH (0004 and 0005) have to contain the start address of the memory area which the data block has to be moved to (somewhere inside the EPROM).

The duplicate routine can be started from address 0222, whereupon the display is blanked. Each time a memory location is programmed the display will light briefly to indicate how the process is progressing. Once the entire data block has been programmed into the EPROM the Junior Computer will display the last address +1.

The verify routine

This routine enables selected data blocks to be compared with the contents of the EPROM. Again, the start address, the end address +1 and the destination address have to be entered before the routine is started (start address = 0233).

The program will stop when (or if) an error is detected. The address containing the error will then appear on the display, together with the data contained in the EPROM at that location. If any key is then depressed (except for 'reset' or 'NMI') the program will continue with its check. After the final check the Junior Computer will display the last address +1.

With all the information provided in this article, it should be possible to program your own EPROMs quickly and efficiently. You will soon discover the advantages of having your very own EPROM programmer. M

An induction loop paging system provides wireless transmission of information and can be used as a personal paging system in factories, warehouses, etc. or as a hearing aid in cinemas, theatres, etc. To be viable, the system should be very economically priced. The requirements for constructing such a system are: a (powerful) audio amplifier; a loop of wire that marks the periphery of the area to be covered; a sensitive audio amplifier for each 'participant'. The latter must be able to sufficiently amplify the energy pro-

The (audio) induction loop paging system only operates in the audio frequency range and is prone to interference from television sets and thyristor or triac controlled dimmer circuits. If an induction loop paging system is required, possible interference sources in the surroundings must be taken into account. Advantages of the system are: low cost and no visible connection (direct or indirect) between the 'transmitter' and 'receiver'.

There are certain disadvantages of this type of system: not only can the neighbour's television and dimmer controls cause interference, but any attempts to minimise this interference by increasing the power output have an inverse effect as well. The magnetic field of the induction loop paging system will generate a voltage in any surrounding coils. Such a coil could be formed by an existing earth circuit in electronic equipment. This indicates that interference will be caused to stereo equipment containing magnetic or moving coil cartridges. Another 'victim' would be a tape recorder due the coil of the record head, which is connected to a very sensitive amplifier circuit. The induction loop paging system could also interfere with an electric guitar.

This means that if an induction loop paging system is to be employed on a small scale, it is necessary to ensure that the system does not cause interference to or receive interference from other systems. Therefore, some form of modulation has to be implemented.

On the one hand, the frequencies used

duced in a small pick-up coil (see figure 1).

The lines of (magnetic) flux are perpendicular to the area produced and bordered by the paging system. Although this system can be used in all the above mentioned cases, an infra-red system is more commonly used. Compared with the induction loop paging system, an infra-red system has many more advantages if only a small area has to be covered, the main points being greater bandwidth and less chance of interference.

induction loop paging system

Short range paging systems are normally used in large buildings or by people with very poor hearing. The system described in this article has many more applications: it can be used as a 'wireless' connection for radio or TV sound, as a baby alarm, as a doorbell extension or even as an intercom system.

1

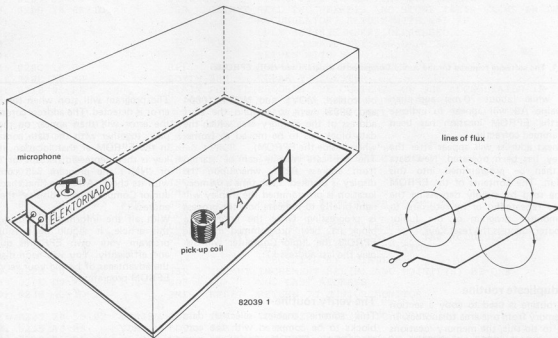

82039 1

Figure 1. The basic idea behind the induction loop paging system. The lines of flux are perpendicular to the actual induction loop.

2

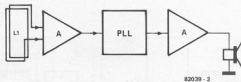

Figure 2. The receiver consists of a preamplifier, a phase-locked loop demodulator and an audio amplifier.

have to remain in the audio range, to satisfy Home Office requirements, and on the other, they must be inaudible. Consequently, the bandwidth of the system will have to be limited. Although the circuit described in this article is capable of operating with a bandwidth of 6 kHz, it has been limited to 3 kHz. This still provides excellent speech intelligibility, for which the induction loop paging system is primarily intended. Normally, persons with impaired hearing are unable to detect higher frequencies, so the limited bandwidth will not be that much of a problem for them. Music reproduced over the system can be compared with 'transistor radio' quality.

The induction loop paging system utilises frequency modulation with a carrier frequency of around 24 kHz. This is still within the audio spectrum, although it is inaudible to the human ear. The major advantage of frequency

modulation is the fact that interference to and from other equipment is very much reduced. The use of FM does not eliminate interference completely, but it is certainly superior to other methods of modulation.

There are two main reasons why the frequencies used have to remain in the audio range. In the first place, it is much easier to process audio signals than it is to process high frequency (RF) signals. Secondly, the induction loop paging system starts to show increasing 'aerial effect' with higher frequencies, which is intolerable with regard to the possible interference caused. What is more, the law prescribes that the information must not 'leave' the house!

The receiver

The block diagram of the receiver is illustrated in figure 2. The induced out-

put from the pick-up coil is amplified, demodulated by a phase-locked loop (PLL) and fed to an audio amplifier. If required, an additional headphone amplifier could also be connected. There are a number of ways in which such a block diagram can be realised. In the design presented here, particular attention has been paid to low cost, easy construction and also a limit has been imposed on the size of the printed circuit board.

The complete circuit diagram of the receiver section is shown in figure 3. The pick-up coil has an inductance value of 6 mH. The diameter of this coil is 3 cm. The coil and capacitor C1 form a resonant circuit with a frequency of around 24 kHz. This signal is then amplified by transistors T1 and T2 and 'clipped' by transistors T3 and T4 to compensate for high amplitude input signals. The overall gain from the pick-up coil to the PLL is considerable. The induced voltage in the coil is only a few microvolts, whereas the PLL requires a signal in the order of 500 mV_{p-p} for correct operation.

Noise is unavoidable in wide-band amplifiers, and the four stage circuit shown in figure 3 is no exception. However, this is not necessarily a problem, as the PLL is not so sensitive to harmonics and sub-harmonics as it is to the fundamental frequency. By including capacitor C8, the high frequency content of the input signal is reduced slightly, which is quite sufficient. A CMOS phase-locked loop (type 4046) is used for the FM demodulator for the

3

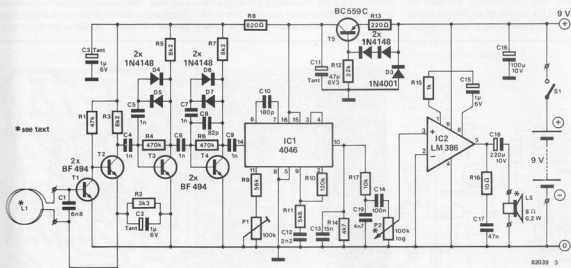

Figure 3. The circuit diagram of the complete receiver. Current consumption is only 10 mA.

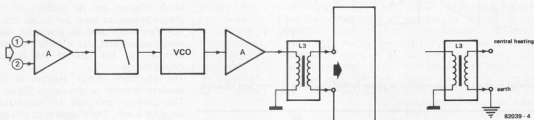

Figure 4. The block diagram of the transmitter section of the induction loop paging system.

following reasons; its low voltage supply requirements; its low current consumption and (more importantly?) its low cost. One disadvantage is that the VCO frequency is not particularly stable. This slight drawback is compensated for by the wide tuning range provided by preset potentiometer P1. Moreover, this disadvantage is virtually eliminated due to the fact that this device has a very wide capture and hold range.

The zener diode contained in the IC (pin 15) is used to stabilise the supply voltage to the PLL and the preamplifier. The zener voltage is between 5 and 6 V. The actual value is not critical, but any change (as a result of decreasing battery voltage) is. The frequency of the VCO is dependent on the supply voltage as well as the conversion constant (which is the relationship between the frequency and the control voltage) of the PLL. This means that the resultant output voltage could vary with changes

in supply voltage even though the input signal is constant. For this reason, the usual series dropper resistor associated with zener diodes is replaced by a series transistor (T5). Thus the receiver can still be used with a supply voltage of about 6 V without motor-boating (low frequency oscillation).

The audio amplifier produces a power output in the region of 0.5 W. To make the receiver as compact as possible, an IC has been used here. However, the major drawback here is the fact that this device has a current consumption in the order of 7 mA. The total current consumption of the receiver is about 10 mA. Therefore, the choice between 'ordinary' batteries and NiCad cells depends on how often and for how long the receiver is to be used.

The receiver has a very high sensitivity, which offers the advantage of being able to operate far beyond the periphery of the induction loop when there is little

or no interference present. However, this parameter is not obtained automatically. Radiation from the moving coil of the loudspeaker (or the dynamic headphone) and radiation from the induction loop could have a detrimental effect on each other if the installation is not carried out correctly.

The transmitter

The block diagram and the circuit diagram for the transmitter section of the induction loop paging system are shown in figures 4 and 5, respectively. The transmitter consists of a low frequency preamplifier, a VCO and a 'switching' output stage. The input preamplifier is a simple mixer to which two possible signal sources can be connected. Input 1 is the most sensitive and has the lowest input impedance. Sensitive, low impedance microphones can be connected directly to this input.

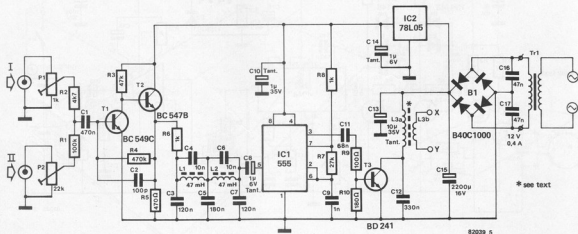

Figure 5. The circuit diagram of the transmitter. The induction loop is connected to points x and y.

6

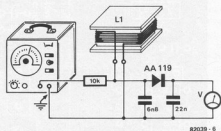

Figure 6. The correct number of turns for the pick-up coil can be determined quite simply using this set-up. The signal generator should have an accuracy greater than 5%.

The other input can be used with higher level signals such as the line output of an audio amplifier. A low-pass filter has been added after the preamplifier to reduce any high frequency interference.

For example, let us assume that input 2 is connected to the sound output of a television receiver. This means that the line oscillator frequency (about 16 kHz) will also be present — especially with cheaper sets. This gives a difference of about 8 kHz when a carrier frequency of 24 kHz is used. Moreover, the third harmonic of the TV line oscillator and the second harmonic of the VCO are very close to each other. In other words, interference would be very prominent. A similar example can be given with the 19 kHz and 38 kHz products of an FM stereo receiver. Therefore, it is imperative to reduce the bandwidth of the signal presented to the transmitter VCO.

A simple active filter is not sufficient, as the attenuation of the filter has to increase rapidly beyond a certain frequency value. A passive LC filter is ideal, especially as very few components are required. The filter used in the transmitter, consisting of L1, L2 and C3...C7, provides 6 dB attenuation at a frequency of 3 kHz and as much as 60 dB attenuation at a frequency of 5.5 kHz. The attenuation will never be less than 70 dB for higher frequencies (up to 50 kHz).

The transmitter VCO is constructed around a 555 timer. This provides excellent frequency stability and sufficient 'power' to drive the output stage. Unfortunately, this device has its limitations in that the frequency modulation obtained is not absolutely perfect and a slight amplitude modulation of the output signal occurs. This, however, is not noticeable in the receiver due to the limiters and the AM suppression

7

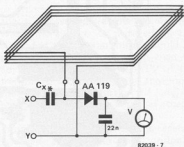

Figure 7. In order to achieve optimum efficiency, the induction loop should be series resonant. Using the method shown here, the maximum meter reading will indicate the correct value for C_x .

Parts list for the receiver

Resistors:

- R1 = 4k7
- R2 = 3k3
- R3,R5,R7 = 8k2
- R4,R6 = 470 k
- R8 = 820 Ω
- R9 = 56 k
- R10 = 120 k
- R11 = 5k7
- R12 = 22 k
- R13 = 220 Ω
- R14 = 4k7
- R15 = 1 k
- R16 = 10 Ω
- R17 = 10 k
- P1,P2 = 100 k preset

Capacitors:

- C1 = 6n8
- C2,C3 = 1 μ 6 V tantalum
- C4...C7,C9 = 1 n ceramic
- C8 = 82 p
- C10 = 180 p
- C11 = 47 μ 6 V tantalum
- C12 = 2n2
- C13 = 15 n
- C14 = 100 n
- C15 = 1 μ 6 V
- C16 = 100 μ 10 V
- C17 = 47 n
- C18 = 220 μ 10 V
- C19 = 4n7

Semiconductors:

- T1...T4 = BF 494
- T5 = BC 559C
- D1,D2,D4...D7 = 1N4148
- D3 = 1N4001
- IC1 = 4046
- IC2 = LM 386

Miscellaneous:

- L1 = 500 turns of 0.1 mm ϕ , enamelled copper wire coil diameter about 3 cm (see text)
- S1 = on/off switch

8

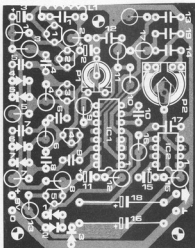
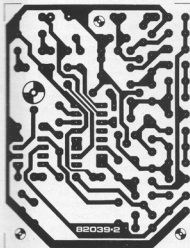

Figure 8. The printed circuit board and component overlay for the receiver section.

9

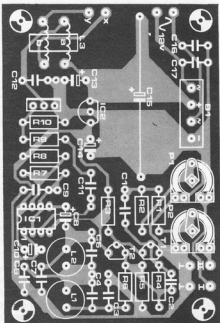
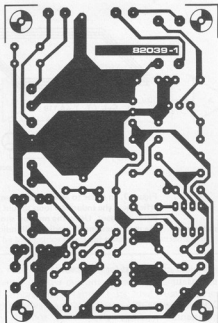

Figure 9. The printed circuit board and component overlay for the transmitter section.

provided by the PLL. The linearity of the 555 VCO leaves much to be desired, but it has no disturbing effect on the quality of reproduction.

Transistor T3 amplifies the VCO output signal in order to supply the induction loop of the paging system with sufficient power. The signal has to be filtered before it is fed to the loop and some form of coupling between the loop and the output stage must be found. It is recommended to isolate the loop from the output stage. This can be accomplished by using a (modified) 40 μH 'anti-interference' coil (for example, a toroid as used in light dimmers). This then functions as a 'tank' circuit. Although the efficiency is not particularly impressive at the operating frequency of 24 kHz, it serves the purpose quite well. Attenuation of harmonics is quite considerable, which is useful for this application.

The modification to the toroid is very simple and is performed by adding a number of secondary windings around the coil. For a typical living room, ten secondary windings are sufficient. In this way the circuit is electrically isolated from the loop itself. There is plenty of room to wind the secondary around the toroid with well insulated wire, the diameter of which should be at least 0.5 mm.

Construction

Installation of the transmitter will be dependent on the application. If it is used for TV sound, it may be possible

Parts list for the transmitter

Resistors:

R1 = 100 k
R2 = 4k7
R3 = 47 k
R4 = 470 k
R5 = 470 Ω
R6, R8 = 1 k
R7 = 27 k
R9 = 100 Ω
R10 = 180 Ω
P1 = 1 k preset
P2 = 22 k preset

Capacitors:

C1 = 470 n
C2 = 100 p
C3, C7 = 120 n
C4, C6 = 10 n
C5 = 180 n
C8, C14 = 1 μF 50 V Tantalum
C9 = 1 n
C10 = 1 μF 35 V Tantalum
C11 = 68 n
C12 = 330 n
C13 = 10 μF 35 V Tantalum
C15 = 2200 μF 16 V
C16, C17 = 47 n

Semiconductors:

T1 = BC 549C
T2 = BC 547B
T3 = BD 241
IC1 = 555
IC2 = 78L05
B1 = B40C1000 (1 amp) bridge rectifier

Miscellaneous:

L1, L2 = 47 mH microchoke
L3a = 40 μH anti-interference coil
L3b = insulated copper wire
Cu $\phi > 0.5$ mm on L3a (see text)
Tr1 = 12 V/0.4 A transformer

to mount the transmitter inside the TV cabinet. It may even be possible to derive the power supply for the transmitter from the TV, especially if a circuit diagram is available. A word of warning: remember that the guarantee may not be effective if additional circuitry is added. Also, the majority of TV sets do not use a mains transformer and very often the chassis is live!

The current consumption of the transmitter is about 400 mA, which means that it should not be too difficult to construct a suitable power supply if the need should arise. It is preferable to connect the audio input to a signal source which can not be influenced by external means — before the volume control! It is important to make sure that the coils of the low-pass filter (L1 and L2) are not situated in the vicinity of supply transformers. If the circuit is mounted inside a TV receiver, it should not be placed near the line oscillator, the line transformer or the deflection coils.

As far as the receiver is concerned, it is advisable to wind the pick-up coil around the inside of the housing to be used. Consequently, it may not be possible to use the type of coil illustrated in the diagram. The inductance value of 6 mH is essential, along with the size of the coil which should occupy at least 7 cm^2 . The shape of the coil is not important as long as the above conditions are fulfilled.

It is always difficult to predict how many turns are actually required. The easiest solution is to wind a hundred

turns around the coil, connect a 6n8 capacitor across it and determine the resonant frequency with the aid of a signal generator. Thus, having found the resonant frequency to be 79 kHz, for example, the number of turns required would be: $(100 \times 79) / 24 = 329$. This method is quite accurate enough. The test 'set-up' is shown in figure 6. It is important to ensure that the signal generator used is accurately calibrated. If there is any doubt, the final check can be carried out with the transmitter instead of the tone generator. The value of the parallel capacitor should be between 4n7 and 8n2, otherwise the bandwidth of the circuit would be outside the preset limits.

The connection leads to the pick-up coil should be as short as possible. This is not necessarily a problem as the connection points for the coil are situated near the edge of the printed circuit board (see figure 8). As mentioned previously, there should be no form of coupling between the input and output, as otherwise the sensitivity of the receiver would be drastically reduced. Consequently, the connections to the loudspeaker or headphone have to be installed as far away as possible from the input.

Although the transmitter output can be connected directly to the induction loop, a considerable increase in signal strength can be gained by tuning the loop. Figure 7 illustrates how this can be accomplished. Initially, the value of capacitor C_x should be 22 n when the measuring circuit is connected to the induction loop. The meter reading should be noted. The value of C_x is then increased until the meter reading starts to drop. The capacitor value which gives the highest reading should then be connected between point X

and the loop. In practice, the value of the capacitor, which forms a series resonant circuit with the loop, will be somewhere between 47 and 680 n.

Although the loop is now 'tuned', it does not mean that the system necessarily operates at maximum effectiveness. For example, a 'free' induction loop formed by central heating or water pipes would have a much lower inductance value than a 'living room' loop with four turns, but the range of the 'free' loop would be much greater. The reader is quite free to experiment with different kinds of induction loop, as long as the output stage of the transmitter is not overloaded. With a correct 'interface' the voltage at points x and y will be around 2...6 V_{P-P}. Therefore, a reading of 1...3 V will be obtained with the half-wave rectifier circuit given in figure 7.

Perfectionists can also experiment with the number of turns for L3b, after having found the correct value for the series capacitor C_x . The optimum number will be that which gives a maximum reading on the test set-up of figure 7. Although a gain of as much as 20 dB can be obtained by tuning the induction loop, it is not really necessary if the system is to be used indoors. However, tuning will reduce interference from other sources quite considerably.

Operation

Firstly, it is essential to make sure that no mistakes were made during construction. This is especially true of the transmitter as the 555 timer and output transistor will just not cope with short circuits! Once everything has been checked and found to be satisfactory, the trans-

mitter can be turned on and a suitable audio signal (speech or music) connected to the input. The induction loop is then connected to the output, bearing in mind the point made previously about the voltage across points x-y. When the receiver is switched on the signal fed to the transmitter should be audible. The input level can then be adjusted by means of P1 or P2 of the transmitter (depending on the input used) until the distortion (if any) is reduced to a minimum and/or is acceptable.

Preset potentiometer P1 in the receiver is then adjusted to give optimum reproduction of the transmitted signal. In order to perform this adjustment correctly, the receiver should be moved away from the transmitter until reception is barely audible, since the capture range of the PLL is very wide. The setting of P1 can be checked by switching the receiver off for a moment. When it is turned back on, the PLL must lock in immediately.

If the PLL does lock, but the sound level differs from the previous level, the VCO will be tuned to a harmonic or sub-harmonic of the fundamental frequency. When the PLL is correctly locked the voltage at pin 9 of the 4046 will be in the region of 2...3 V. This value can only be measured with a high impedance (FET) voltmeter. If such an instrument is not available, the voltage at pin 10 can be measured, which should be about 0...0.5 V greater than that at pin 9.

As can be expected, the results that can be achieved with a correctly set up circuit depend entirely on the type of induction loop used and the 'interface' to the transmitter. The prototype was tested using a set-up similar to a normal living room. A television set was even placed inside the area of the induction loop (22 m²) to provide an interference source. Besides this, the system was also tested with a 'free' induction loop comprised of an earth connection and the central heating pipes. The results obtained are as follows: Using a single 'untuned' winding the system was usable to a distance of 2 m outside the loop area. However, the receiver could not be used any closer than 2 m to the TV set without interference from the line oscillator.

With a 'tuned' loop of three windings the receiver could be used as close as 1.5 m to the TV. The reception was still acceptable up to a distance of 4 m outside the area.

When the central heating pipes were used as the induction loop, the system exhibited an acceptable reception range of 20 m. After tuning, the signal-to-noise ratio improved and the range outside the building increased to 50 m.

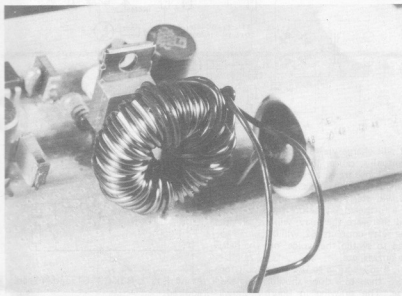

Photo. This close-up illustrates the relative size of the pick-up coil of the paging system.

MINI CIRCUITS

PENCE TO SAVE POUNDS

diode dimmer

A relatively expensive 'luxury' dimmer is not really required to reduce the brightness of the house lights. In many cases it would probably be a lot easier and certainly cheaper to connect a diode in series with the light in question.



Figure 1 gives a clear indication of what is meant. The negative half-cycles of the mains voltage are 'blocked' by the diode so that the voltage across the lamp is reduced to half that of the mains supply. This means that the lamp will not only consume less electricity and therefore give less light, but also the lifespan of the bulb will be considerably increased. This will be a particularly useful addition in situations where bulbs are rather difficult to replace.

Due to the half-wave rectification of the mains voltage, the bulb will tend to 'flicker'. However, the flicker effect is reduced once the bulb has warmed up a

little and will probably not be noticeable.

The best position for the diode is to mount it directly behind the switch and connect it in series with the neutral lead. The current rating of the diode depends on the power rating of the bulb used. Taking the switch-on current of a cold bulb into account, a 2 A diode will suffice for a 100 W bulb.

2a D1 = 1N4004, 1N4005, 1N4006, 1N4007

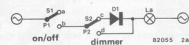
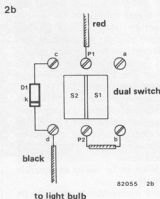

Figure 2a shows how the bulb can be switched between full and half brightness. The single pole switch from figure 1 has been replaced by a dual switch. Switch S1 is used to turn the light on and off, while S2 is used to select the level of brightness. Figure 2b shows the method of wiring the two switches. Two of the connection terminals are marked 'P' (for phase) by the manufacturer. In the diagram these are

indicated by P1 and P2. The other terminal indications correspond to those in figure 2a.



Note: the connection terminals of your dual switch may well not coincide with those given in figure 2b. It would be as well to check this with the aid of an ohmmeter before starting to construct the circuit.

open door reminder

Doors are the most maligned of inanimate objects. They take the blame for being open/shut at the wrong time and even for existing at all. While they are convenient for allowing the passage of people, pets, bread, milk and letters, the parallel input of fresh air is not always as acceptable, especially in the Winter months (the period between September and May!). Have you noticed that the colder it is, the harder the rest of the world tries to keep your front door open?

The obvious answer would be to give your door a voice and let it tell you when it is open. That is exactly what the circuit described here is intended for. Admittedly, the vocabulary is fairly limited, but on the other hand, we have not used even one microprocessor. In fact the voice (and word) is down to personal choice between a bell or a buzzer, with an optional Klaxon for some households.

However, on to the circuit shown in figure 1. Switch S1 is operated by the door and will open when the door is opened. When this happens, capacitor

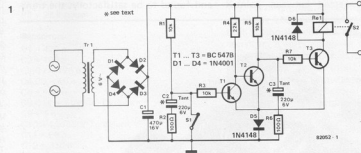

C2 will charge via resistor R1 and will eventually cause the Schmitt trigger formed by transistors T1 and T2 to change state. At this point capacitor C3 will start to charge and there will be a further delay before transistor T3, and therefore the relay, will switch on. The relay contacts, S2, will of course be used to switch the 'voice' on, the bell, the buzzer, etc.

It is also possible to use the circuit for more than one door should the need arise. The drawing in figure 2 shows how two 'open door detectors' are connected in parallel. For each additional door to be covered, a further

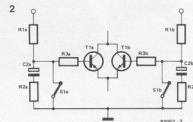

set of R1... R3, C2, S1 and T1 are required.

Switch S1 can take many forms, but a magnet and reed relay would seem the most obvious choice.

MINI CIRCUITS

PENCE TO SAVE POUNDS

water indicator

This particular circuit emits a penetrating 'howl' to report any form of undesirable humidity, ranging from a leaking washing machine, an overflowing bath or kettle, etc. to a baby's wet nappy.

Most readers will be familiar with the straightforward principle behind the circuit. Since water is to a certain extent conductive, humidity will reduce the resistance between two metal contacts. In this circuit the two sensors form a resistance between the base of transistor T1 and ground. Provided the resistance

is very high (which it will be in a dry environment), no base current will flow and T1 will not conduct. In a humid environment, on the other hand, there will be less resistance, so that T1 will start to conduct and will also cause transistors T2 and T3 to conduct. The latter now provides IC1 with supply current. IC1 is an AF amplifier which is connected as a multivibrator here. It starts to oscillate and produces a very clear warning signal with a frequency of around 2 kHz, by way of the loudspeaker. Since the circuit hardly consumes any current at all, it can easily be powered from a small 9 V battery.

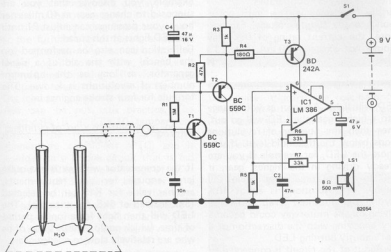

safety switch for stereo equipment

... switches off automatically

Well over half the damage to homes through fire is caused by domestic equipment being left on for excessive periods of time. Stereo equipment is only one of the many items which are easily forgotten about. It is not unusual, after a hectic day (or night) to listen to a favourite record, tape or radio programme to gain a little relaxation. This works so well that as weary listeners drift off into oblivion the last thing likely to be on their minds is to turn off the stereo! Another point worth noting, but not half as important as the safety aspect, is the increase in the electricity bill.

If the simple circuit described here is incorporated into the stereo equipment, or the television set for that matter, there will be no need to worry about these items being the cause for a rude, smoky awakening in the small hours. The circuit is designed to switch off the equipment after about 5 minutes of silence.

The principle of operation is as follows: The auxiliary output signal from the amplifier is boosted considerably by opamps A1 and A2 (by at least two volts). Preset potentiometer P1 is used to adjust the gain between 47x and 4700x. This provides a very wide sensitivity range, which is absolutely necessary as the equipment must not be

A1 ... A4 = IC1 = LM 324

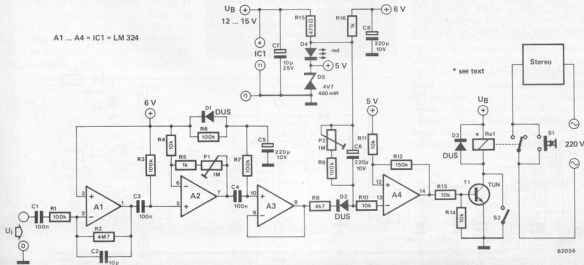

* see text

MINI CIRCUITS

PENCE TO SAVE POUNDS

allowed to switch itself off when the volume of the music is low.

Opamp A3 acts simply as a buffer amplifier, after which the input signal is rectified and smoothed by diode D1 and capacitor C6, respectively. Provided the voltage across capacitor C6 exceeds a certain value, the output of the Schmitt trigger, A4, will go high, transistor T1 will conduct and the relay will be activated. If, however, the voltage across C6 drops below the threshold of the Schmitt trigger, the output of A4 will go low and the relay will be deactivated. The stereo equipment is now switched off.

The rate at which the voltage across C6 drops is determined by the setting of preset potentiometer P2 and corresponds to the period of silence required before everything is turned off. This interval can be adjusted between roughly 1 and

10 minutes. If necessary, the automatic switch can be bypassed by means of switch S2.

Once the safety switch has been turned on, the relay contacts will have to be 'shorted' by switch S1, as otherwise the circuit will not be provided with any supply voltage and the relay will not be activated! The supply voltage may be derived from either the tuner or the power amplifier (or the television, if practicable). A 12V IC voltage regulator may be added in this instance, if only high voltage levels are present inside the apparatus. The current consumption of the circuit is about 15 mA (at 12V) when the relay is not operated.

Finally, the relay voltage must correspond to the supply voltage. Furthermore, the current rating of the relay should not exceed 100 mA, for T1's sake!

going edges of the output pulses from the Schmitt trigger are fed to a monoflop, constructed around A2. By integrating the monoflop output pulses by means of R10/C3 and R11/C4 a d.c. voltage corresponding to the pulse frequency (number of revolutions) is obtained. This is then fed to a window comparator, A3 and A4. The LED will only light when the number of revolutions is within the preset 'window', for example between 3000 and 3300 revolutions per minute.

Calibration of the circuit is very simple and can be done 'on the road' provided it is not done by the driver. If, for example, you discover that you are supposed to change gear at 40 miles per hour, your passenger can adjust P1 until the LED lights at this speed.

Calibration can also be performed 'on the bench' with the aid of a signal generator, as long as the optimum number of revolutions is known. The formula for four-stroke engines is:

$$f = \frac{\text{no. of revolutions} \times \text{no. of cylinders}}{120}$$

If the comparator window is not quite large enough for your requirements, another value for R13 can be selected (8k2 instead of 6k8, for example). The LED will then light for a longer period of time, which could benefit those of us who are relatively slow to change gears.

optical speed indicator

A number of car manufacturers are now installing 'gear change' indicators into their latest models. The idea is that an LED lights as soon as you have to change gear. When you drive such a car as this for the first time, you will be surprised to discover that you are 'asked' to change gear a lot earlier than you would have thought necessary. The device is intended to save petrol, and therefore money, as the indicator is set to give the vehicle the most efficient fuel consumption.

The circuit described here is a simple tachometer using a single LED as the speed indicator. After a preset number of revolutions have been reached the

LED will light. As soon as you change into a higher gear the LED will go out, since then the number of revolutions drops below the threshold level. If you ignore the LED, for example if you are already driving in the highest gear, it will go out automatically when the number of revolutions is about 10% beyond the threshold level. Otherwise driving on the motorway could become very annoying with the distraction of a continuously burning LED.

The input of the circuit is connected to the contact breaker points. A low pass filter comprised of R1 and C1 suppress the contact bounce of the points. A Schmitt trigger, constructed around opamp A1 (1/2 LM 324) shapes the pulses derived from the points. The positive-

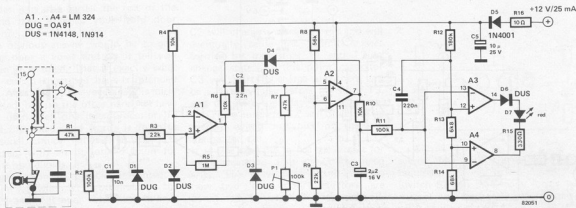

MINI CIRCUITS

PENCE TO SAVE POUNDS

20°C + indicator

Temperatures greater than 20°C throughout the house are more than most people can afford nowadays. The trouble is, when it is snug and warm they are less inclined to notice that the heating is up too high (they literally get into a sweat thinking about the bill!) than when it is a little chilly and their teeth start to chatter. Heating systems that do not include thermostat regulation can now be provided with an electronic 'excess temperature indicator'. As a result, money and energy can be saved without having to suffer severe discomfort.

An optical temperature display, in the form of a thermometer for instance, has the disadvantage that it becomes 'part of the furniture' and therefore attracts little attention. An acoustic warning device, on the other hand, produces a high-pitched tone that will make inmates sit up and take action (or at least bark!). The circuit in figure 1 shows how this idea can be put into practice. The resistor R4 is a KTY 10 temperature sensor. The resistor has a positive temperature coefficient (PTC) and is included in a bridge circuit that is fed with a stabilised supply voltage of +5 V. IC1 is a 3130 opamp and acts as a bridge amplifier. As long as the room temperature is below the threshold value set by means of P1 (coarse adjustment) and P2 (fine adjustment) respectively, the output of IC1 will be zero volts. As soon as the room temperature exceeds this value, however, the voltage at the non-inverting input (pin 3) of the opamp will be higher than the voltage at the other input (pin 2), so that the output (pin 8) will go high. This activates the oscillator constructed around N1. Every minute, the oscillator generates a single pulse that lasts about

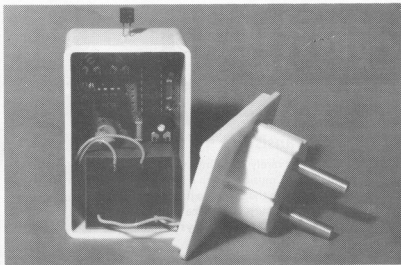

0.2 seconds. By way of the inverter N2, the pulse triggers the oscillator N3 which then produces a warning signal. The tone signal has a frequency of about 5 kHz and drives the buzzer (a piezo-electric miniature loudspeaker) connected between the input and the

output of the gate N4. Since the transducer provides a clear tone at about 4.6 kHz, P3 can be used to set both the frequency and the volume.

The circuit is an energy-saver in every sense of the word, for it requires very little current. Since not more than 2 mA is consumed, the power supply can be very straightforward. It is best to include this, together with the circuit, in a small case with an earth contact that is cast in it (see photo). The sensor should be mounted on the outside of the case, to prevent a wrong temperature indication due to the transformer getting 'overheated'.

Before the circuit is calibrated, the points marked 'A' and 'B' in the circuit diagram are linked. P1 is then adjusted until the buzzer 'squeaks'. P3 is then turned to select the desired volume.

P1 and P2 are preset for a room temperature corresponding to the required threshold value. At the right temperature level, in other words, the alarm will not be sounded, but as soon as this is exceeded, the buzzer will emit a high-pitched tone. Once the link A-B has been removed, the energy-saving temperature indicator will be ready for use.

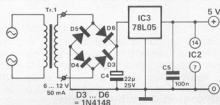
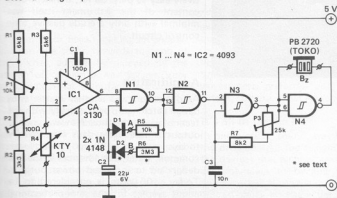
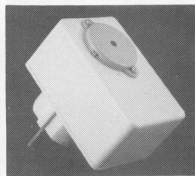

guitar amplifier philosophy

'tubes' and transistors

Guitar sound systems rarely come into the limelight where electronics are concerned, but the musician with a lively interest in our hobby will wonder at what point in the technological progress line his equipment stands at. The answer is surprising since a large percentage of the amplifiers available do not live in today's technology at all, but very definitely yesterdays.

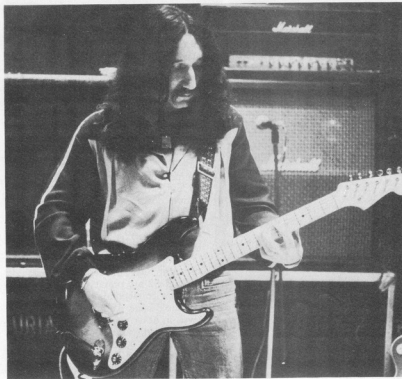

Michael Box does his thing with a very well known combination.

How big a part does the progress of electronics play in today's stage sound equipment? It could be assumed that, with the current integrated circuit technology being what it is, stage equipment would be entirely solid state at a high level of sophistication. The obvious advantages of high performance, low operating temperatures and low weight, when related to valve amplification, would seem to make it a foregone conclusion that 'solid state' has completely ousted the poor old valve.

The real facts are, however, quite the reverse. It would appear that in many cases it is the poor old transistor that is being pushed aside by the valve. While it is true that excellent solid state amplifiers are produced by companies like Carlsbro and H/H it is significant that eminently well known manufacturers such as Fender and Marshall still rely virtually entirely on the valve. How is it possible that such a situation could exist today with the prospects of digital audio just around the corner? For an answer to this we must look deeper than pure electronics.

The trouble really started way back in the thirties with the blame resting squarely on the shoulders of people like Les Paul who, for a variety of reasons, were not content to just play the guitar, they wanted, of all things, to 'electrify' it. Les Paul went even further by inventing multi-track recording by utilising such well known principles as a bathroom, a garage and a Cadillac flywheel, but that's another story.

The electrified guitar, however, did have a very real place in music during the 'thirties' and early 'forties'. The acoustic guitar was originally used as a rhythm instrument but, as could be expected, many guitarists wanted to 'do their own thing' in a lead role. These musicians were continually frustrated by having to compete with other instruments having a much higher natural volume output. The electrified (or amplified as it was known) guitar was therefore greeted with much enthusiasm by guitarists who were hoping to get their own back on that pianist and his eighty eight notes!

It was not long before the true electric guitar was born (with more than a little help from Leo Fender), an instrument that had a good sound and was relatively easy to play. So far, the electronic content of the instrument itself was minimal with only a crude passive tone control circuit.

Amplification

Amplification was another matter with design catching up very quickly with the technology of the time. However, power output in the early days was low by today's standards, 10 to 15 watts was common. Later, the advances in speaker design led to increased power outputs. Today, 100 watts is considered to be about average for the semi-professional



Photo 2. Two very fine instruments from different eras. The early Gibson Charley Christian on the left is a good example of an 'electrified' guitar. The Gibson on the right is a solid-bodied Standard 80 Elite from the current Les Paul range.

musician.

The transistor began making an appearance on the scene towards the end of the 'sixties, admittedly delayed by the late arrival of high power devices. Very soon almost all manufacturers viewed solid state as the answer to all the problems that are hereditary to valves. The early 'seventies saw the decline in the popularity of valve amplifiers in preference to the reliable, low cost, easily transportable solid state types. The way ahead looked clear with all that the rapidly expanding IC technology had to offer. Quite un-

expectedly however, a rapid reversal took place with an increase in demand for valve equipment. Never mind the high specifications, never mind the all time low noise and distortion figures, valves were preferred and, to a large extent, still are. What went wrong?

It's all in the ear!

In one word — 'sound' was the cause of the problem. All the design abilities and the devices that technology had to offer did not seem to be able to give the musician that elusive ingredient that he desired above all else — the valve sound.

Exactly what the valve sound is forms the basis of a long-standing controversy that will probably end up in the mist of time as a musical legend! Justifiably, designers claim that their solid state amplifiers boast performance figures never before achieved in the history of stage sound equipment. On the other hand, musicians are not particularly interested in performance figures. They don't really care if a half empty bean can constitutes the 'secret ingredient' providing it produces the sound that they are looking for.

So where are transistors now? To say that they are dead is totally untrue, for there are many extremely good solid state amplifiers available with very respectable power outputs. In fact, transistors form the basis of most, if not all, of the very high power amplifiers. Two notable examples shown here are from the excellent H/H and Carlsbro stables. There is also a ready acceptance of solid state for use in PA systems where colouration is not a desirable feature. The area where the transistor has really made strong headway is in the professional field of recording studios. Here the valve is virtually unknown and this is, of course, to be entirely expected.

Power

Only one figure regarding specifications is really interesting to the working musician. This is the power output of the amplifier. In the early days, a small amplifier (by today's standards) with a 10 watt output was all that was readily available to most musicians with an average income. Although Fender amplifiers were obtainable from America (at a price) it took the British company of Vox with their excellent AC 30 to supply what the guitarist really wanted. The AC 30 only had a rated output in the order of 30 watts but it could be overdriven to an alarming degree. It also had that other prerequisite — its own distinctive sound, and a good one at that. A list of the groups who used Vox equipment reads like a who's of English and American pop music as a glance at figure 1 will show. The early Shadows recordings are probably the most well known instrumental examples of the Vox sound then used with Fender guitars). Even today, some guitarists still prefer to use the AC 30 but now normally stacked up in banks of four or more.

Some examples of contemporary amplifiers can be seen in the photographs on these pages. By appearances alone it is very difficult to judge whether each is solid state or 'tubed'.

Guitars

A particular sound is not, of course, entirely a product of the amplifier alone. Many factors contribute, including the guitar (and the strings used). When a guitarist is lucky enough to achieve his own unique sound (almost always after

1

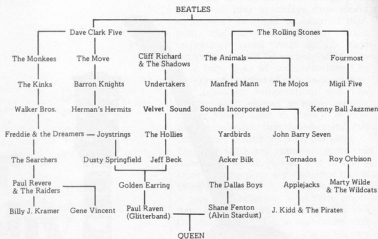

Figure 1. The Vox AC30 was probably the most successful amplifier in England as this chart of the groups who used it shows. It was standard equipment for virtually all guitarists of the time.

a great deal of time and effort) how it is obtained then becomes a closely guarded secret. It is sufficient to say that changing any element in the chain will change the sound.

Once again however, whether it is a Gibson, Fender, Rickenbacker or another of the well known guitars, pure electronics plays virtually no part at all. With the possible exception of pickup development, the tone circuits of the guitar have not changed significantly since the early days. Some brave manufacturers have produced instruments with fully active tone control networks, complete with plug in modules, but with little far reaching success. And what of the future? Apart from iso-

lated instances — no change. The guitarist appears to be quite happy with today's instrument.

Effects units

No self-respecting guitarist travels without his armoury of pedals and things. These contribute to his music in much the same way that a recipe does to a menu. Fuzz units, waa-waa pedals, high boosters and many others, too numerous to mention, were all born in the solid state era and therefore technology thrives here.

Synthesisers, while not specifically effects units, are a good example of the marriage between electronics and music.

The outlook for home construction

So, after all this, why doesn't Elektor go ahead and design a valve amplifier? A reasonable question but the fact exists that a valve amplifier is just not a practical proposition for the home

3

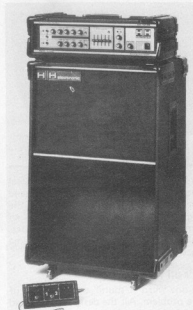

Photo 3. A trio of very high power amplifiers. The Marshall is valved while both the Carlsbro and the H/H are solid state.

4



Photo 4. Two well known 'combos'. Both are valued.

constructor. The costs involved for the hobbyist would be out of all proportion to the results gained when compared to a transistor design. Further to this, the design of a very versatile preamp is relatively simple when transistors are used. If a fuzz unit is also incorporated in the pre-amp, the overall sound will then approach that of a valve amplifier.

Output stages

The output section of a stage amplifier provides little or no headroom, to a certain extent, for the home constructor. In principle, virtually any output stage is suitable and Elektor has published a fair share of suitable power amplifier designs in the past. However, it is advisable to protect the input of the power amplifier by means of two zener diodes mounted 'back-to-back' and a resistor.

In practice, the heatsink for a domestic power amplifier tends to be too small to cope with full power for long periods. It is best to cover the whole rear wall of the case with a heatsink as this not only solves all heat problems, but also helps the mechanical stability of the finished article.

Power supplies do not need to meet any particularly high standard. In general, stabilised power supplies tend to produce too low a voltage at full load. An unstabilised supply with a generous mains transformer, rectifier and large smoothing capacitor is far superior for this application. In fact, the larger the

smoothing capacitor, the better. When the smoothing capacitors in the Elektornado power supply were changed to 2 x 30,000 μ F in stead of 2 x 5,000 μ F the difference was clearly noticeable.

Fuse failure indicators are also a very useful 'extra', both in power supplies and in the positive and negative supply lines to the power amplifier. Ordinary LEDs can be used to indicate the failure if placed next to the fuse. This also saves problems when checking the various fuse holders in the dark when a great shuddering silence has descended in the middle of a performance.

Preamplifiers

Preamplifiers vary according to the particular application. Figure 2 shows a low noise preamplifier similar in design to commercial units. It has two separate channels, each one with two inputs of

different sensitivity. The first channel (input 1) includes an active triple tone control followed by an FET switch for the reverberation unit. The latter can be activated either by using a foot switch or the front panel mounted toggle switch. The driver for the reverb line consists of a small audio power amplifier IC with switch both ordinary spring-line and electronic reverb units can be used. The 22 k preset potentiometer controls the volume of the reverb signal and the depth of reverb is determined by the 10 k potentiometer.

The second amplifier channel (input II) offers many more tone control possibilities. Three variable band pass filters follow a bass/treble control circuit having the usual frequency characteristics. Again, this channel contains a reverberation driver which can be switched in either by foot or by hand.

The following is a list of the sound equipment used on stage by The Who during their recent tour. Since a spare is required for virtually everything, the total amount of equipment carried is double this quantity.

<i>P. Townshend</i>	2 x Hi-Watt 100 W amplifiers
	4 x Hi-Watt 4 x 12 cabinets
	1 x MXR compressor
	Schekter guitars
<i>J. Entwistle</i>	4 x Sunn Coliseum 200 W slave amplifiers
	2 x Stramp pre-amps
	1 x Alembic input module
	3 x Sunn 4 x 12 cabinets
	3 x Mega-whystle 1 x 18 cabinet
	Alembic Custom bass guitars

On stage monitors

Custom Midas monitor desk (24 channels - 8 outputs)

3 way front fills	4 x 4560 bins
	2 x 2440 mid horns
	2 x 2448 high horns
	2 x Martin 1 x 15 bins
3 way back fills	2 x Martin 2 x 12 mid range units
	2 x Gauss HF 4000
2 way floor monitors	6 x floor wedges
	2 x Harwell floor wedges
	2 x 4560 bins
drum monitors	2 x 2480 lens
	2 x 2440 horns
	2 x Dynachord echo units
	2 x Korg echo units
	1 x MXR phaser
	1 x MXR D.D.L
backing	2 x Scully 4 track tape machines
tapes	1 x Koss headphones
	Shure microphones
	All above powered by 17 Crown DC 300 A amplifiers



All the above equipment fits in this — The Who's 'tranny'.

5

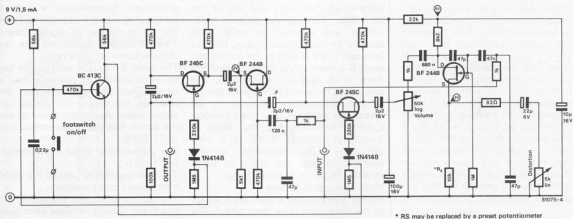

Figure 5. Since different requirements have to be met for a rhythm player, it is better to use a separate fuzz unit.

guitars is shown in figure 4. This is only used for solos. The 'clipper' is a low pass filter with a cut-off frequency of 7 kHz and a slope of 16 dB/octave. FETs are used to switch the circuit from distorted to undistorted and vice versa. The current consumption of the entire circuit is very low compared to other units on the market — a 9V mally battery will virtually last for months. A filter is incorporated to produce a distorted sound without peaks, as otherwise the guitar will sound very harsh. Provided a quality guitar is used, a different sound may be obtained by changing the cut-off frequency. A rhythm fuzz unit is shown in figure 5. This circuit is based on the following considerations:

When a fuzz unit is switched on and adjusted so that it 'sounds good' for the lead guitar, it will not be suitable for playing rhythm. If the unit is then

adjusted for the rhythm guitar, the undistorted signal sounds very 'thin'. In addition, when the gain of the amplifier is turned up a guitar chord will sound 'diffuse' and a single note will be much louder. Reducing the output of the guitar does not make any appreciable difference, therefore it is better to use a separate fuzz unit for rhythm work which sounds much softer and more harmonious.

The unit shown in figure 5 is a variation of the more usual FET circuit containing an impedance converter for the bypass switch. Again, current consumption is down to a minimum, about 1...2 mA, therefore the circuit can quite easily be powered by batteries. Many commercial foot operated units need a battery change every 10 hours! The fuzz unit is designed so that no squarewave signals are produced — the sinewave signal is easily 'upset', but not

clipped. This circuit enables subtle distortion to be obtained to give chords the required drive without distorting them beyond recognition. If the two fuzz units are combined, the guitar will no longer sound so thin and dry when switched from lead to rhythm. It should not be too difficult to obtain preset levels either by ear or with the aid of an oscilloscope.

A combination lead/rhythm fuzz unit is shown in figure 6. In this unswitched unit the effect increases as the gain control potentiometer is turned up. It is similar in operation to a valve amplifier: at low volume the amplifier sounds clean and dry, at higher volumes the distortion level also increases. Following the fuzz stage is a master volume potentiometer, which is a good idea if a little haphazard in operation.

6

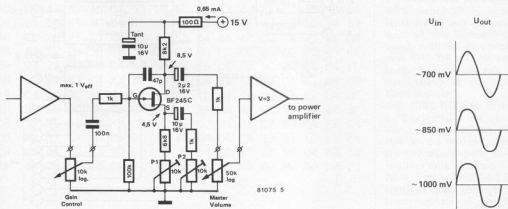

Figure 6. This fuzz circuit is suitable for both lead and rhythm guitarists. Similar to valve amplifiers, the distortion increases with volume.

The NIBL interpreter is one of the few that do not utilise a UART for the serial transfer of data into and out of the computer. Instead, the data is transmitted and received in serial form directly by the microprocessor. For this purpose, flag 0 is used as the output and sense B is used as the input. Conversion from serial data to parallel data, and vice versa, is accomplished with the aid of two subroutines contained in the interpreter program. For these reasons, together with the fact that NIBL is (normally) held in ROM, it is very difficult — if not impossible — for the operator to alter the speed of transmission. However, it can be done!

NIBL operates as follows: During transmission a start bit is added to the data word to be transmitted. The term 'start bit' rightly implies that this bit is transmitted first (via flag 0), the

bits in the data word will follow. Finally, two stop bits complete the procedure. Transmission is performed by copying the various bits into flag 0 in the status register at regular intervals. This effectively determines the transmission speed (or baud rate).

The sense B input is continually tested to check whether or not serial data is to be received. As soon as a start bit is detected, the data is transferred to the accumulator. Again, the speed at which the data is received is determined by the NIBL ROM.

The transmission speed is dependent on two factors:

The time required to process the relevant instructions in the program.

The delay instructions pertaining to the input and output routines belonging to NIBL.

In practice this means that the trans-

W. Taphoorn

NIBL 1200 GT

faster BASIC

Readers who have constructed the BASIC microcomputer (Elektor May 1979, page 5-34) and who are not completely satisfied with the low printing speed — this article is for you. It describes an 'add-on' circuit which will enable transmission speeds of up to 1200 baud. The BASIC microcomputer itself needs no modification, the only requirement is that the address decoder (IC9) has to be moved to the add-on circuit.

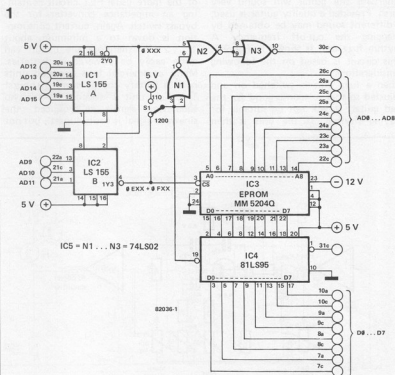

Figure 1. The circuit diagram of the NIBL 1200 GT add-on unit. IC1 is the address decoder formerly situated on the BASIC microcomputer board.

Table 1

NIBL SC/MP II baud rate changes

EPROM address	ROM address	110 baud	300 baud	600 baud	1200 baud
185	0F85	C3	29	8A	BB
187	0F87	08	03	01	00
194	0F94	45	11	D4	34
196	0F96	11	06	02	01
189	0F89	11	06	03	01
1C4	0FC4	8B	6C	2D	99
1C6	0FC6	2F	06	03	01
1D0	0FD0	54	21	E5	44
1D2	0FD2	11	06	02	01

Table 1. The nine address locations which require modification for the various baud rates.

Table 2

1E00	15	0B	25	06	30	01	2F	02	83	2E	12	45	4E	C4	01	2F
1E10	02	7F	2E	26	4C	49	4E	CB	8E	35	01	2F	06	30	09	15
1E20	09	66	06	30	02	83	2E	2F	52	45	CD	09	B8	02	83	02
1E30	1A	8F	2F	02	A9	8E	61	2E	3E	BD	8E	61	05	43	2E	53
1E40	BC	2E	48	BD	8E	61	05	4F	2E	4F	BE	8E	61	05	47	8E
1E50	61	05	4B	2E	8B	BE	2E	5D	BD	8E	61	05	57	8E	61	05
1E60	53	2E	6A	AD	8E	8D	03	5A	4E	6F	2E	6D	AB	8E	8D	2E
1E70	78	AB	8E	8D	03	2C	4E	6F	2E	81	AD	8E	8D	03	43	4E
1E80	6F	2E	8B	4F	D2	8E	8D	05	EB	4E	6F	00	F5	8E	AC	2E
1E90	98	AA	8E	AC	03	71	4E	8F	2E	A1	AF	8E	AC	04	07	4E
1EA0	8F	2E	8B	41	4E	C4	8E	AC	05	E7	4E	8F	04	E0	0E	B4
1EB0	05	2B	00	F5	06	AB	0E	BA	00	F5	2E	C1	A3	06	4B	00
1EC0	F5	2E	CB	A8	8E	35	2E	2F	A9	00	F5	2E	D4	C0	8E	AC
1ED0	07	E9	00	F5	2E	DF	4E	4F	D4	8E	AC	05	EF	00	F5	2E
1EE0	E9	53	54	41	D4	09	55	00	F5	2E	F4	54	4F	D0	0B	97
1EF0	09	93	00	F5	2F	01	4D	4F	C4	8F	20	04	07	09	BF	00
1F00	F5	2F	16	52	4E	C4	8F	20	09	D1	03	43	03	2C	04	07
1F10	09	BF	03	2C	00	F5	2E	2F	50	41	47	C5	0B	7A	00	F5
1F20	2E	2F	A8	8E	35	2E	2F	AC	8E	35	2E	2F	A9	00	F5	06
1F30	30	01	8E	04	07	01	C5	06	30	00	F5	20	45	52	52	4F
1F40	D2	41	52	45	C1	53	54	4D	D4	43	48	41	D2	53	4E	54
1F50	D8	56	41	4C	D5	45	4E	44	A2	4E	4F	47	CF	52	54	52
1F60	CE	4E	45	53	D4	4E	45	58	D4	4E	4F	D2	44	49	56	B0
1F70	42	52	CB	55	4E	54	CC	C4	08	CA	EB	06	DC	02	07	06
1F80	D4	20	9C	FB	C4	XX	8F	XX	06	D4	20	9C	F2	06	D4	FD
1F90	DC	01	07	C4	XX	8F	XX	06	D4	20	98	04	C4	01	90	04
1FA0	C4	00	9C	00	CA	EA	1F	01	1D	01	06	DC	01	E2	EA	07
1FB0	BA	EB	9C	0F	D6	D4	FE	07	8F	XX	04	D4	7F	01	40	3F
1FC0	90	B5	01	C4	XX	8F	XX	06	DC	01	07	C4	09	CA	EB	C4
1FD0	XX	8F	XX	BA	E8	98	10	40	D4	01	CA	E9	01	1C	01	06
1FE0	DC	01	E2	E9	07	90	E8	06	D4	FE	07	3F	90	D4	00	00
1FF0	00	00	00	00	00	00	00	00	00	00	00	00	00	00	00	00

Table 2. The complete listing of the memory area containing the modified input/output routines. This data is stored in the new EPROM.

mission speed can be modified by altering the effective length of the delay instructions — there are five that we are interested in. As these instructions are contained in ROM it is not easy to alter them. An alternative method must be found.

National Semiconductor have been kind enough to locate the input/output routines in the 'top end' of memory. This means that if this section of memory is disabled at the correct time it can be replaced by a new (modified) section which can be stored in EPROM. The only concern now is to 'fool' the microprocessor into thinking that it is addressing the NIBL ROM when in fact the EPROM is being accessed. Only then will the NIBL interpreter operate at a different speed.

The nine changes to the five delay instructions are listed in table 1. The values shown in the 110 baud column should be the same as those presently stored in the NIBL ROM. The speed chosen is dependent on the peripheral device being used. For instance, the maximum speed of the Elekterminal is 1200 baud, but the maximum speed of a printer could be a lot less!

Circuit diagram

As mentioned previously, the address decoder (IC9) is removed from the BASIC microcomputer board and is now used to address the memory range 0000...0FFF. This address range is still used to access the NIBL ROM. A second address decoder, IC2, is used to enable the address range 0E00...0FFF, which is where the input/output routines were originally located. Now, however, these routines are relocated in the EPROM, IC3. The device shown is a 5204 type, which many readers may already possess, especially those who are no longer using ELBUG. Any other 512 x 8 bit EPROM can be used however, depending on availability and 'programmability'.

With switch S3 in position '110' the NIBL ROM, and its slow input/output routines, will be selected. On the other hand, with S3 in position '1200', the new EPROM will be selected and the transmission speed will depend on the data stored at the various locations listed in table 1.

The NIBL ROM is effectively disabled by placing IC11 on the BASIC card in the tri-state position. Simultaneously, IC4 in the add-on circuit is enabled, thereby allowing the new input/output routines to be accessed.

Note: the MM 5204Q EPROM has a relatively slow access time as far as the later version of the SC/MP microprocessor (INS 8060) is concerned. For correct operation the 'slow memory access' circuit published in the March 1980 issue of Elektor should be incorporated.

single channel infra-red remote control

Single channel infra-red remote control systems are often used in modelling and for simple circuits in and around the home. The basic requirements for such a transmitter/receiver system are: an uncomplicated circuit which does not use special components and coils; easy construction using a minimum number of components; screening against ambient light; sufficient range (with or without a focusing lens); low current drain. All the above can be accomplished by using the circuit described here.

Transmitter

The circuit diagram of the transmitter section of the remote control unit is shown in figure 1. An astable multivibrator constructed around two CMOS gates, N3 and N4, oscillates at a frequency of approximately 20 kHz, as long as the output of N2 is high (logic one). This situation occurs when switch S1 is depressed — the input of N1 goes high therefore the output of N1 goes low taking the output of N2 high. After a set period of time (1 ms), determined by the values of R1 and C1, capacitor C1 discharges through R1 taking the input of N1, and the output of N2, low. This inhibits the oscillator. Capacitor C2 serves to suppress interference caused by contact bounce.

The Darlington output stage, T1/T2, is

driven by the oscillator while the latter is enabled. These transistors in turn deliver peak currents of up to 1 A to the infra-red diodes, D1...D3, via capacitor C4. The circuit is designed in such a way that a single battery (with a capacity of 200 mAh) will provide upwards of a million operations (transmissions). The quiescent current consumption of the transmitter section is a mere 300 nA! If required, the Darlington output stage, T1/T2, can be replaced by a single BD 875 transistor. If only one infra-red LED is used, with a focusing lens, a resistor with a value of 2Ω should be connected in series with it.

Receiver

The circuit diagram of the receiver section of the infra-red remote control system is shown in figure 2. Radiations

Technical data

Transmitter
operating voltage 9 V
(single) pulse duration 1 ms
carrier frequency 20 kHz
peak current 1 A

Receiver
operating voltage 9 V
operating current (without LEDs) 2 mA
gain 80 dB
range (in line, without focusing lens) 15 m
range (with focusing lens, 25 mm dia) 40 m

1

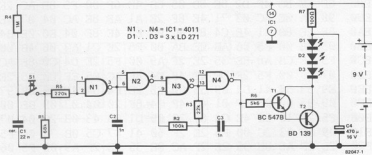

Figure 1. The circuit diagram of the infra-red transmitter.

2

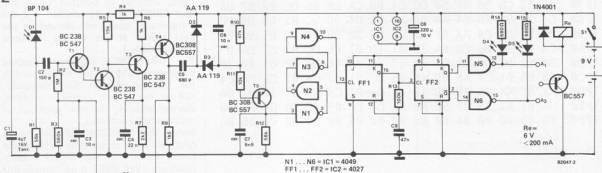

Figure 2. The circuit diagram of the single channel infra-red receiver.

from the transmitter are detected by the infra-red photo diode, D1. The cathode connection of this device (BP 104) is marked either by a blue dot or by a little 'bump'. The photo diode is biased by means of resistor R1, the value of which has been chosen such that operation of the diode is 'favourable' under normal (ambient) lighting conditions. The following amplifier stages, constructed around transistors T1/T2 and T3/T4, amplify the input signal by a factor of 80 dB (= 10,000 times). Negative feedback is supplied via resistor R8. The amplified output signal appears at the collector of T4 and is rectified by diodes D2 and D3.

Every input pulse (20 kHz) causes an increase in charge across capacitor C6. The rate of charge is dependent on the relationship between capacitors C5 and C6 as well as the amplitude of the output signal. Transistor T5 will conduct as soon as the voltage across C6 reaches the threshold voltage of this transistor. A positive going trigger pulse will then appear at the collector of T5. The rectifier circuit, consisting of C5, C6, D2, D3 and R10, is designed to reduce spurious switching operations caused by interference pulses to a minimum.

The series of gates, N1...N4, serve to shape the leading edge of the output pulse from T5. This provides a 'pure' trigger pulse for the following flipflop, FF1. In the quiescent state the 'Q' output of this flipflop is low (logic zero). When a trigger pulse is received the 'Q' output goes high (logic one). At the same time, capacitor C9 is charged via resistor R13. This means that after about 3 ms FF1 is reset - the 'Q' output of FF1 will go low. The negative going edge of this pulse is used to clock flipflop FF2. Therefore, the outputs of FF2 change state after a fixed number of input pulses have been received. The 'Q' and 'Q-bar' outputs of FF2 are buffered by gates N5 and N6. These gates also act as drivers for the two LEDs D4 and D5 which serve to indicate the present condition of the outputs. It is advisable, therefore, to use different coloured LEDs for this purpose to avoid confusion.

If required, the receiver can be used to operate two relays via the A1 and A2 outputs as shown in figure 2.

The quiescent current consumption of the receiver section is in the order of 2 mA. Therefore, it is advisable to power the receiver from a stabilised supply rather than from a battery supply.

A final remark about interference. It may prove necessary in some instances to screen the receiver diode from ambient light to avoid spurious switching. If the problem still occurs a 10...22 pF capacitor can be connected in parallel with resistor R8 and as a final resort the value of R10 can be reduced. This latter, however, will also reduce the effective range of the unit.

frequency multiplier

low frequency module for counters

The circuit described here allows low frequencies (below 2 kHz) to be measured accurately on a 'normal' frequency counter. With so-called 'universal' counters the problem of measuring low frequencies is usually solved by measuring the period of the signal. This then involves a little simple arithmetic. In order to be able to read off the frequency directly, the signal has to be multiplied by a certain factor until it is within the range of the measuring instrument.

The hand-held LCD frequency counter described in the November 1981 issue of *Elektor* and the 150 MHz counter described elsewhere in this issue both suffer from one slight drawback. They are unable to accurately measure signals with frequencies below 2 kHz. As there is no provision for measuring the period of a given signal on the FM77T module, an alternative method had to be found. The most obvious solution was to design a frequency multiplier which would increase the frequency of the incoming signal by a

factor of a thousand. This was accomplished quite simply and as a bonus, the resolution of the frequency counter increased from 100 Hz to 0.1 Hz.

The end result is that if a signal with a frequency of 100 Hz is fed to the LCD frequency counter via the multiplier module, the counter will indicate a reading of 0.1 kHz. This value (0.1) multiplied by 1000 equals 100, which just happens to be the frequency of the input signal. Since the 'kHz' legend is not really required here it can be disconnected.

1

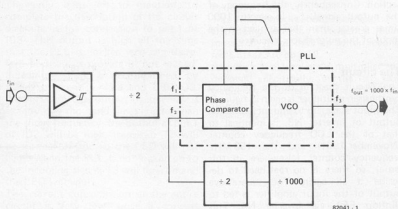

Figure 1. The block diagram of the frequency multiplier shows that the essential part of the circuit is a PLL (phase-locked loop).

Frequency synthesis

In modern parlance, a frequency multiplier is very often called a frequency synthesiser. The block diagram of a frequency synthesiser, the most important part of which is a phase-locked loop (PLL), is shown in figure 1. First of all, the incoming signal is converted into a 'true' squarewave. The actual frequency multiplier consists of a phase comparator, a low pass filter, a voltage controlled oscillator (VCO) and a frequency divider. All these components are contained in the PLL section.

The principle of operation should be fairly straightforward to understand. The phase comparator, as its name suggests, compares the frequency of the input signal, f_1 , with the output frequency of the divider, f_2 . The low pass filter connected to the output of the phase comparator removes all unwanted harmonics and supplies a d.c. signal to the input of the VCO. The voltage level of this control signal is determined by the phase difference between the two signals fed to the comparator inputs.

For the phase-locked loop to remain 'locked' the frequency of the VCO, f_3 , has to be exactly two thousand times greater than the input frequency, f_1 . This is because the VCO output signal is divided by 2000 before being fed back to the phase comparator ($f_2 = f_3/2000$). This should be sufficient theory about the operation of the PLL, so let us return to the block diagram.

The two divide-by-two stages are quite simply flipflops, as many readers may have already discovered. The flipflop directly in front of the phase comparator ensures that the frequency of the incoming signal has a duty cycle of exactly 50%. This is done because it is necessary to provide the phase comparator with an absolutely 'pure' signal in order to maximise the lock range. The effects of this flipflop are neutralised by a second flipflop which is situated after the divide-by-thousand section. Consequently, the frequency of the output signal, f_3 , is exactly 1000 times greater than that applied to the input of the pulse shaper circuitry.

The circuit

The circuit diagram of the frequency synthesiser/multiplier is given in figure 2. The input stage, up to and including the output of inverter N3, is identical to that of the LCD frequency counter (November 1981) and the 150 MHz frequency counter (elsewhere in this issue), so there is no real need to describe it all again. The squarewave output of the input amplifier is fed to flipflop FF1 via inverter N4. This ensures that the signal presented to the first input of the phase comparator has a duty cycle of exactly 50%. The phase comparator section of the PLL is indicated as $\psi 1$ in the circuit diagram. The second input to the comparator is

2

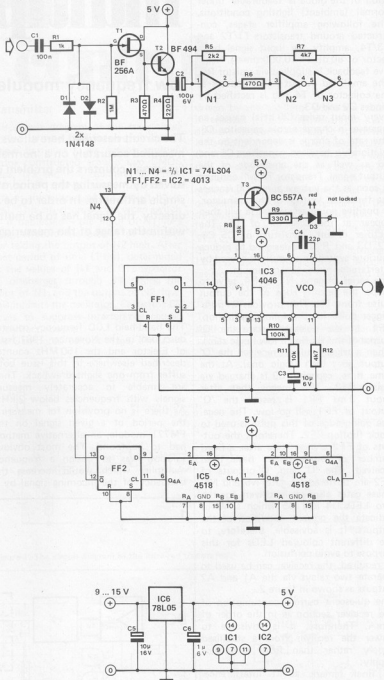

Figure 2. The complete circuit diagram of the frequency multiplier. The phase-locked loop is formed by a single CMOS integrated circuit.

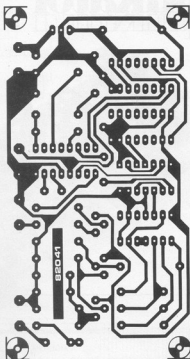
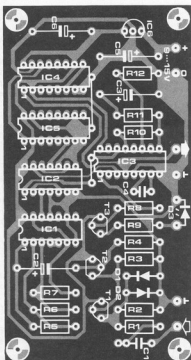

Figure 3. The printed circuit board and component overlay for the frequency multiplier. The input and output leads should be kept as short as possible to reduce noise effects.

Parts List

Resistors:

R1 = 1 k
 R2 = 1 M
 R3, R6 = 470 Ω
 R4 = 220 Ω
 R5 = 2k2
 R7, R12 = 4k7
 R8 = 18 k
 R9 = 330 Ω
 R10 = 100 k
 R11 = 10 k

Capacitors:

C1 = 100 n
 C2 = 100 μ /6 V
 C3 = 10 μ /6 V
 C4 = 22 p
 C5, C6 = 10 μ /16 V

Semiconductors:

D1, D2 = 1N4148
 D3 = red LED
 T1 = BF 256A
 T2 = BF 494
 T3 = BC 557A
 IC1 = 74LS04
 IC2 = 4013
 IC3 = 4046
 IC4, IC5 = 4518
 IC6 = 78L05

derived from the VCO frequency, which is first divided by 2000 via IC4, IC5 and FF2. The output of the phase comparator is fed to the input of the VCO via the low pass filter consisting of resistors R10, R11 and capacitor C3. The values of these components are such that the PLL will only respond to signal frequencies greater than about 18 Hz. The fundamental frequency of the VCO is determined by capacitor C4 and resistor R12.

The only item left to mention, to complete the description of the circuit diagram, is the connection to pin 1 of IC3. This output is high all the time that the PLL is 'locked' and can therefore be used to provide a 'not locked' indication. This is accomplished by means of transistor T3 and LED D3. When the VCO output frequency is exactly one thousand times greater than the input frequency, the output at pin 1 of IC3 will be high, transistor T3 will be turned off and so the LED will not light. When the PLL is not locked on to the incoming signal, T3 will turn on and the LED will light.

The current consumption of the entire circuit is very low, since it consists mainly of CMOS ICs. The supply voltage is stabilised via the voltage regulator IC6. Power can be derived either from a 9 V battery (PP3) or from the frequency counter used with the multiplier module.

Construction

The printed circuit board and component overlay for the multiplier module is shown in figure 3. All the components shown in the circuit diagram can be mounted on this board. The length of the various connecting leads should be kept as short as possible, especially if the unit is to be installed inside an existing frequency counter. In this instance, a switch can be used to select between 'normal' operation and the multiplier.

Two final remarks about the circuit: Depending on the frequency being measured, it can take up to ten seconds for LED D3 to go out!

Although the frequency multiplier was designed specifically for the two LCD frequency counters mentioned earlier, it can of course be used with other frequency counters as well.

Literature

Data sheet CD 4046B, COS/MOS Micro-power Phase-Locked Loop, RCA.
 D. Lancaster, *The CMOS Cookery Book*.
 R. Best, *Theory and Applications of the Phase-Locked Loop*.

applikator

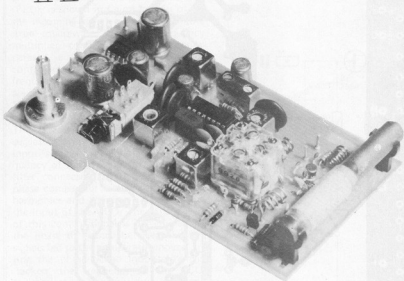

compact AM/FM receiver

1

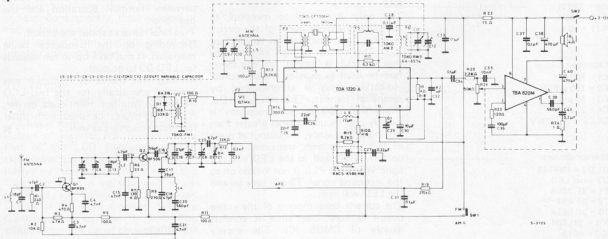

The Elektor library receives many interesting application notes from component manufacturers, some more interesting than others. While we do not make a practice of publishing complete data sheets, however, application or design notes can sometimes be very useful. Such is the case with the TDA 1220A from SGS-Ates.

This IC forms the basis of a complete AM/FM receiver with many outstanding features. Current consumption is only 9 mA making it ideal for use as a portable receiver.

The AM section of the TDA 1220A IC consists of a preamplifier, a mixer, an oscillator, an IF amplifier including an internal AGC and a push-pull detector. The FM section contains an IF amplifier, a limiter, a quadrature-detector and a VLF preamplifier.

The circuit's other advantages include low noise, high sensitivity, high stability and DC controlled AM/FM conversion.

The circuit diagram in figure 1 shows a complete, battery powered receiver which can be built into a very compact set, as can be seen from the photograph. All that needs to be connected are a 9 V battery, a 4 Ω loud-speaker and an FM aerial (a piece of wire) and the home-built portable radio is ready for use. What's more, it is much better in quality than the many cheap, imported radios commonly available.

SGS-Ates have also provided a printed circuit board layout and, since construction should not prove too great a problem we have included it in this article. It must be emphasised that it has not been built and tested by the Elektor staff, but that does not mean that the many readers who would like to should be deprived of the chance. Elektor will not be producing a printed circuit board, but all the basic essentials are published here for a 'from the ground up' constructional project that many readers may find appealing. ■

Source:

TDA 1220A: Data sheet and Application from Data Book, Linear Integrated Circuit 2nd Edition;

SGS-ATES (UK) Ltd., Planar House, Walton Street, Aylesbury, Bucks.

2

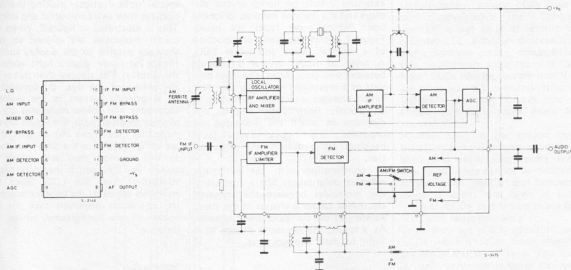

Figure 2. The pinout and internal block diagram of the TDA 1220A.

3

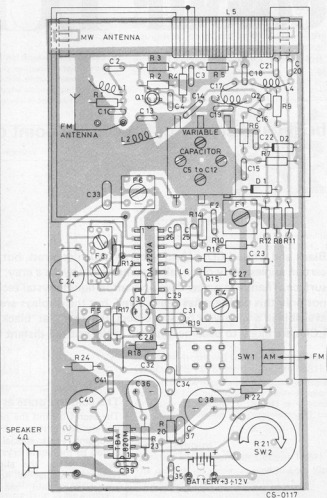
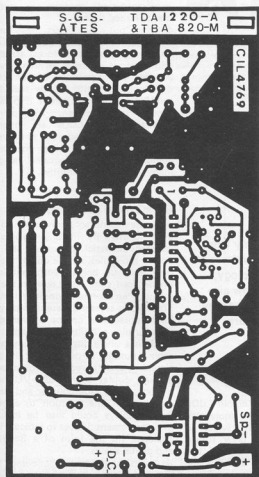

Figure 3. The printed circuit board track pattern and component layout for the AM/FM receiver was designed by SGS-Ates.

In May 1980 Elektor published an extensive article on liquid crystal displays and the 'twisted nematic' principle upon which most types are based. Figure 1 shows the basic construction of a 'normal' black and white LCD. A layer of liquid crystal is situated between two glass plates. The layer consists of a crystalline molecular structure which changes under the influence of an electric field. Depending on the direction in which the molecules are organised, the liquid crystal layer becomes either transparent or reflective.

In combination with the externally adhesive polarisation filters, 'capsizing' the molecules between the triggered electrodes causes a change in the transparency of the corresponding segments. As a result, the segments change from 'light' to 'dark' and vice versa.

Rotating the colour molecules has a special optical effect, making the new displays look extra colourful and bright. This is illustrated in figure 2. When the colour molecules are aligned so that they are parallel to the display surface (figure 2a), they absorb light entering the display. The display then takes on the colour of the dye. By connecting an alternating current to the segment electrodes, the colour molecules are realigned together with the liquid crystal molecules (see figure 2b) so that they are at right angles to the display surface. In this position they are unable to absorb any light which therefore passes straight through the LCD. Since the energised segments are now transparent, the characters displayed take on the colour of the background, white, for instance.

colour LCDs

bright and colourful from every point of view

Black and white LCDs afford a sharp enough contrast, but only from certain angles. Very often, all that meets the eye is a grey, nondescript surface. Thanks to a new development in liquid crystal technology, not only this problem has been solved, but the displays are now also available in a variety of bright colours. It seems that 'black upon grey' LCDs are likely to become obsolete in the not-too-distant future.

The colours rotate as well

The secret behind the new colour LCDs is very straightforward: the molecules, belonging to a special dye which is added to the liquid crystal layer, rotate as well. Since the alignment of the colour molecules is not affected by an electric field, the liquid crystal molecules act as a driving motor. This is known as the 'Guest-Host' principle, the 'guest' being the colour molecule which is driven to rotate by its liquid crystal 'host' molecule.

No filters

So far polarisation filters have not been mentioned with regard to the new displays, and for a very good reason: they are no longer required. This is because the displays maintain the same reflective/transparent contrast in normal, non-polarised light.

Leaving out the filters has further interesting advantages. Polarizers tend to absorb light, are liable to get scratched and fade as a result of temperature changes and humidity. Colour LCDs, on the other hand, can be read from every possible angle, even if polaroid sunglasses are worn. Without the polarizers, the LCDs are brighter, scratch resistant and less sensitive to humidity. What is more, the bright colours offer manufacturers a great many attractive possibilities.

Bring colour to technology

Japanese manufacturers plan to go even further. By literally turning the 'twisted nematic' principle, and the colour molecules, upside down, the display ends up being transparent in an unenergised state and takes on the dye colour in an energised condition instead. This allows several different displays to be mounted one on top of the other, thus forming a 'multi-layer display'. The result is a single display unit which can serve a number of purposes at the same time. In a cassette-recorder, for instance, a single display can act as a VU meter, a clock and a tape counter and simply switch from one function to another. Such displays could also be included in measurement devices to indicate both analogue (in the form of a Bargraph) and digital values.

As far as the production of colour LCD displays is concerned, the Japanese are well ahead of the rest of the world. The displays are already being manufactured by a number of Japanese companies, whereas we know of only one manufacturer producing them in Europe so far.

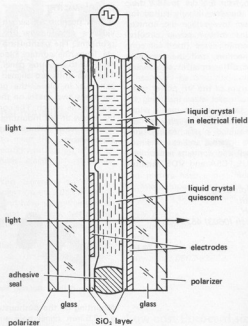

Figure 1. Basic construction of a 'normal' black and white liquid crystal display that is based on the 'twisted nematic' principle. The liquid crystal layer is hermetically enclosed between two glass plates containing transparent, conductive electrodes. The direction of the molecules changes under the influence of an electric field. In combination with the external polarisation filters, 'capsizing' the molecules between the triggered electrodes causes a change in the transparency of the corresponding segment.

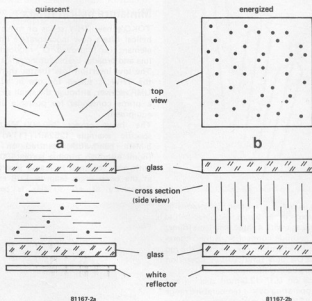

Figure 2. Basic construction of a colour LCD using the 'Guest-Host' principle. Molecules of a special dye are added to the liquid crystal layer. These are rotated by the liquid crystal molecules. In an unenergised state (figure 2a) the colour molecules are parallel to the display surface, so that the display takes on the colour of the dye. In an energised state (figure 2b) the colour molecules are aligned vertically. In this position they are unable to absorb light, as a result of which the energised segments become transparent. They now take on the colour of the background against which the display is held. No polarisation filters are needed.

Colour has its problems too

Unfortunately, colour LCDs have certain disadvantages. Their 'light/dark' contrast is not as good as that of an ordinary LCD, although their readability and brightness amply compensate for this. In addition, some types of 'Guest-Host' LCDs require an operational voltage of at least 5 V, which is rather a lot. Generally speaking, however, the operational voltage is more likely to be about 3 V.

Another snag is that colour displays switch at a much slower rate than their black and white counterparts, and for this reason they cannot be multiplexed as yet. Their lifespan and temperature range is about the same as that of 'normal' LCDs, but temperatures below -10° still cause problems.

Once they are widely available, colour LCDs shouldn't cost much more than the black and white type. The trouble is, only very few samples can be obtained in Europe at the moment and it is difficult to estimate how long it will be before this situation improves. While European firms are obviously still biding their time, the new technology has been greeted with enthusiasm in the U.S.A. and Japan. The next generation of HiFi equipment produced in the 'land of the rising sun' is quite likely to be fitted with all sorts of colourful 'Guest-Host' displays.

missing link

talking board

(Elektor 80, December 1981)

The address given for the word 'seventeen' in EPROM 2 was incorrectly given as 0864. It should be 086A.

frequency doubler

(Elektor 73, May 1981)

In the circuit diagram in figure 3 the + and - inputs of opamp A4 are shown the wrong way round.

'chopper' front end for power supplies

(Elektor 75/76, Summer Circuits 1981)

The circuit starts to 'falter' at output voltages below 3 V (the output voltage may disappear altogether for a while). If the 741 is replaced by a 3140, however, the operation will be correct.

digital keyboard

(Elektor 75/76, Summer Circuits 1981)

The connections shown as pin4 in both IC5 and IC6 is incorrect. It should read pin 2.

teletext decoder (2)

(Elektor 79, November 1981)

The miscellaneous section of the parts list for the decoder board failed to mention that X1 = 6 MHz crystal.

market

20 MHz Oscilloscope

The Hitachi V-202 is a low cost dual trace oscilloscope with a fully dynamic range bandwidth of 20 MHz.

Both vertical channels have a maximum sensitivity of 1mV/division and fully variable controls allow any intermediate sensitivity between attenuator steps. The one-touch channel selector enables the two channels to be added or subtracted if desired.

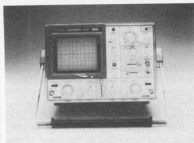

The vertical deflection system provides sweep speeds up to 20 nsec/div with a one-touch X10 magnifier, and the comprehensive triggering system has bright line auto mode and an active sync separator for video signals.

The 5½" rectangular CRT has an internal (parallax free) graticule with variable scale illumination. Automatic focus compensation eliminates the need to reset the focus control when changing the brightness.

Office Suite 1, Coach Mews,
The Broadway, St. Ives,
Huntingdon, Cambs,
PE17 4BN England,
Tel: (0480) 63570.

(2198 M)

High power miniature relay

Diamond H announce the availability of a new miniature, panel-mounted relay designed for high power switching applications.

Designated the Series VF, this fully enclosed power relay contains single-pole, single-throw normally open contacts and is available in three versions with contacts rated at 15 A, 20 A or 25 A at 250 V a.c. It has a high inrush current capability of up to 65 A at

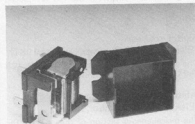

(2195 M)

200 V a.c. With its coil designed for low-voltage d.c. operation, from 6 V d.c. to 48 V d.c., the VF relay is therefore ideally suited for interfacing between low-voltage d.c. control circuits and mains voltage power circuits. Quick connect terminals are fitted for convenient interconnection, and the terminals themselves are of different sizes to prevent cross connection.

An important feature of the VF power relay is its extremely compact size: including its 2-hole mounting flange, it occupies a panel area of less than 2½ sq. in. The relay is fully enclosed in a moulded plastic casing, and provides extensive internal and external isolation between coil and contacts assemblies. It conforms to UL, CSA and VDE requirements.

Diamond H Controls Ltd.,
Vulcan Road North,
Norwich NR6 6AH,
Telephone: Norwich (0603) 45291/9,
Telex: 975163.

(2173 M)

New tri-colour LED

Recently introduced by ZAERIX Electronics Ltd. is a new tri-colour device type L59 HGW which is capable of producing red, green or yellow illumination.

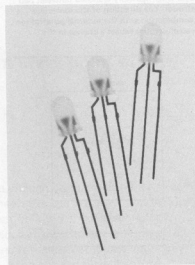

Comprising a red and a green light emitting diode, housed in a 5 mm diameter white diffused package with a three way lead frame, a common cathode connection is used thereby allowing independent operation of the red or green LED's plus simultaneous operation of both giving yellow illumination.

Having leads on 0.1" (2.5 mm) spacing and capable of operating over a temperature range of -40 to +80°C, typical luminous intensity at 20 mA is 3 mcd and power dissipation is between 105 mW and 120 mW.

ZAERIX Electronics Limited,
46 Westbourne Grove,
London W2 5SF, England,
Telephone: 01-221 3642,
Telex: 261306,
Cables: ZAERO, London W2.

Londex pushbutton eliminates panel wiring

A new pushbutton switch from Londex provides a neat answer to front-panel wiring problems. The pushbutton mounting is separate from the contact block, so no wiring is required to the outer panel.

The two units are aligned so that when the panel is in place, the pushbutton plunger depresses two shafts on the contact block to operate the switch. The contact block is fixed by screw or rail mounting within the cabinet or apparatus. Various contact configurations are available.

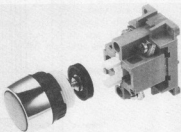

Mounting of the pushbutton unit is through a 22.5 mm panel hole and with a thermo-plastic fixing ring. The button can be with or without a legend insert and snap-on cover cap. Various colours are available. Front of panel protection can be up to IP66. The operating stroke is 7 mm.

Londex Limited,
PO Box 79,
Oakfield Road,
London SE20 8EW,
Tel: 01-659 2424.

(2176 M)

Miniature helical filters

TOKO's new 7HW series of miniature UHF helical filters now incorporate a brass tuning element for improved 'Q', reduced insertion loss and broader usable tuning range.

The low insertion loss (better than 4 dB) of the 7HW is suited for use in all types of UHF receiver, although the small size makes it a prime contender for portable and paging equipment.

The range covers 380-500 MHz, and a specific example (252MN1111A) provides 5 MHz bandwidth, centred on 432 MHz (nom) although tunable across 400-470 MHz with only marginal increased insertion losses at the band edges (approx 1 dB extra loss). Selectivity at +/- 30 MHz is better than

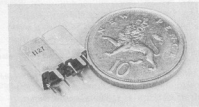

18 dB, with a 70 dB stopband +/- 150 MHz when input/output screening is adequate.

Ambit International,
200 North Service Road,
Brentwood Essex CM14 4SG,
Tel. (0277) 230909,
Telex 995194 AMBIT G

(2199 M)

market

Versatile terminal housings

This new series of computer terminal housings has been designed to meet the requirements of data processing equipment manufacturers, with special emphasis placed on external appearance.

Manufactured in West Germany by Bopla, these housings are injection moulded in structural foam plastic, and have inter-changeable front mouldings giving complete versatility to suit individual requirements.

Available options include apertures for a 12" screen or anodised aluminium panels for mounting floppy disc drives, whilst some models have plain front mouldings and are ideally suitable for power supplies or hard disc drives. All cases can be positioned side by side.

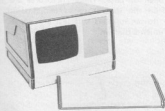

Housings are normally supplied in an attractive brown and cream finish. Keyboard housings are available in the same widths and styling as the terminal enclosures.

West Hyde Developments Ltd.,
Unit 9, Park Street Industrial Estate,
Aylesbury, Buckinghamshire, HP20 1ET,
Tel: Aylesbury (0296) 20441,
Telex: 83570.

(2172 M)

vertical or horizontal presentation. A significant feature of the design is its extreme thinness; the smallest has an overall depth of face of only 13 mm (½ inch) and the two larger sizes about 17 mm (0.673 in). They are, therefore, very compact and, because they can be stacked vertically or horizontally, a considerable density of meter readouts can if necessary be accommodated in a very small space.

The smallest model has a rear-access zero set and a simple springclip method of mounting.

The two larger models have front-access zero set at the end of the scale, and a slide bracket form of mounting. Jewelled pivot movements, with special high-torque magnets are also included.

The meters have a maximum sensitivity of 50 microamperes and scale markings can be produced to suit individual requirements.

Sifam Limited,
Woodland Road,
Torquay
Devon Tq2 7AY.
Telephone: 0803-63822.

(2132 M)

Low-cost Eurocard size microboard

Vero Electronics Limited have launched their first-ever Eurocard size microboard developed specifically for the retail and hobbyist markets.

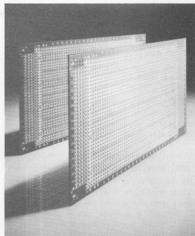

The new, low-cost board is made from SRBP material, and is based on the company's industrial microboards.

Available in two sizes (160 x 100 mm and 160 x 233 mm), the boards are in Eurocard format, fully compatible with indirect connectors and international card frame systems.

They accept any integrated circuit package, and allow high packing density. On the components side, each board is printed with an 'island' pattern for ease of wiring, and is ideal for both solder and wire wrap applications.

Vero Electronics Limited,
Industrial Estate,
Chandler's Ford,
Hampshire SO5 3ZR,
Telephone (04215) 6991

(2181 M)

Overhang cases

Designed specifically for applications encompassing input keyboards and read-out devices, Zaerix Electronics Ltd. have introduced a range of 'overhang' cases.

Available in 2 sizes giving keyboard areas of 145 mm deep by either 255 mm or 388 mm long, the 45 mm high overhang display face provides adequate area for a variety of read-out devices.

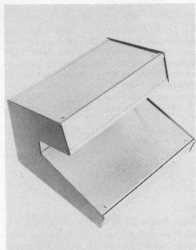

Incorporating pcb guides, rubber base strip mounting feet and a rigid zinc plated steel base, these flat pack supplied units utilise blue stone enamelled aluminium end faces linked by extruded bars onto which anodised aluminium covers are individually located.

By utilising a 'link bar' construction system, end, top, rear and keyboard panels can be independently removed enabling easy access to internal components parts during initial production or servicing.

Providing not only a competitively priced modern style design, the 23° sloping panel and the 75° display face have been ergonomically conceived to enable long term keyboard operation with minimum physical and viewing fatigue.

Zaerix Electronics Limited,
46 Westbourne Grove,
London W2 5SF,
England,
Telephone: 01-221 3642
Telex: 261306
Cables: ZAERO, London W2

(2178 M)

Edgewise meters

A range of very thin edgewise meters manufactured by General Electric, are scaled for

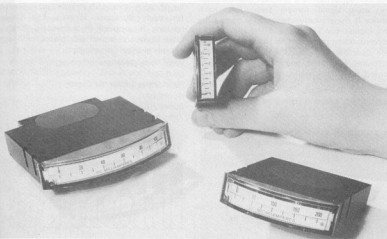

market

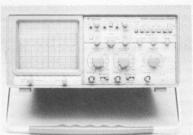

Apple printer

The new RX40-Apple printer is being offered by Roxburgh Printers. It consists of a 40 column PU1840/Z/P thermal mechanism mounted on its own driver card. A ribbon cable enables connection to a special interface that plugs directly into one of the six slots available inside the Apple. All that is required to operate the unit is an external 19 V DC supply for powering the printer mechanism.

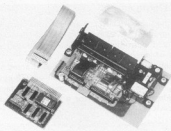

It is possible for most of the graphics facilities used on the Apple to be exploited on hard copy, including 'screen dump' and high resolution graphics. The printer is quiet in operation and can print a page of graphics in 10 seconds.

Roxburgh Printers Ltd.,
22, Winchelsea Road,
RYE,
East Sussex TN31 7BR,
Telephone: (079 73) 3777

(2225 M)

remove flyback signals from X-Y traces. The timebase offers 18 horizontal speed settings of 0.5 μ s/cm to 0.2 sec/cm at an accuracy of $\pm 3\%$, and an additional X10 pushbutton gives a maximum speed of 50 ns/cm. A variable-sweep control also gives continuously variable settings between 50 ns/cm and 0.5 sec/cm.

The comprehensive trigger facilities include a variable-level control with a bright-line 'on/off' feature. With the bright line on, the timebase free-runs when insufficient signal is present, or when the selected level is outside the range of the input signal. D.C. trigger coupling is also provided so that trigger levels do not require adjustment as the mean level changes with variable mark/space ratio on pulse trains. A TV trigger is also incorporated, with an active sync. separator which triggers automatically from the line or frame, depending on the timebase speed, and which retains sync. over a wide range of picture content. This allows details of a broadcast signal such as sync, timing or colour information to be examined.

The OS300 is housed in a rugged case measuring 140 x 305 x 460 mm and weighing 5.8 kg, and is supplied with a fully adjustable handle. It has been designed on a modular basis for ease of maintenance.

Gould Instruments Division,
Roebuck Road,
Hainault,
Essex.

(2223 M)

4000 DTPs which means that test programs for around ten boards can be recorded on one tape. Other features include 24 bidirectional channels, programmable thresholds for 0 and 1 logic levels, a number of internal power supplies with short circuit protection, error display and automatic recycle on the selected DTP. In its basic form, MIT 3 measures 300 x 300 x 150 mm and weighs 12 kg.

Olivetti Tecnost,
Chilteer Manor Chase,
Haslemere Road,
Liphook,
Hampshire, GU307AZ,
Telephone: (0428) 722844

(2228 M)

Unicard cases

A totally new way to house printed circuits is now available from West Hyde Developments Limited in the form of the Unicard series. With its sloping front panel, Unicard is perfectly suited for free standing desk instruments or control units for machinery, and may also be used as a loudspeaker housing, having provision for a built-in loudspeaker grill. Wall mounting is possible using the slots in either the back or base. These enclosures are also ideal in the laboratory as bench trunking, with power supplies and test and measuring instruments built in.

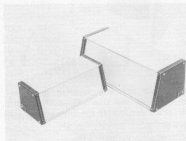

The rear of the housing has been carefully designed, incorporating two T-slots allowing simple attachment of a wall bracket and a flat surface for cable entry. A second panel or PCB can be inserted behind the front panel at the same angle, and further PCBs or chassis can be inserted horizontally or vertically in any of fifteen positions. The extruded aluminium body is plastic coated and is enclosed by means of two moulded plastic side cheeks. Available in two different heights and in any length up to 4 m, with standard sizes available for each Eurocard format. The Unicard housing is supplied in a standard finish of fawn body and brown side plates, with other colours available on request.

West Hyde Developments Ltd.,
Unit 9,
Park Street Industrial Estate,
Aylesbury,
Bucks HP20 1ET,
Telephone: Aylesbury (0296) 20441/5

(2226 M)

Dual-trace 20 MHz oscilloscope

Gould Instruments has introduced a new dual-trace 20 MHz general-purpose oscilloscope, the OS300, which incorporates many facilities normally included in more expensive higher-bandwidth oscilloscopes.

It features a bright 8 x 10 cm rectangular display with a choice of a standard or long-persistence phosphor. The standard phosphor is a P43 (GY) type which has a characteristic similar to the normally used P31 (GH) phosphor but offers improved efficiency at a 2 kV accelerating potential. The -3 dB bandwidth is from d.c. to 20 MHz, and the sensitivity can be adjusted continuously via calibrated controls from 2 mV/cm to 25 V/cm to enable the screen to be scaled directly to different types of input parameters. The two input channels are identical in performance, with an accuracy of $\pm 3\%$.

Several different display modes are available. Apart from the normal single- and dual-trace modes, add and invert modes are included to aid baseline compensation and differential voltage measurements, and X-Y facilities are available for frequency and phase-shift measurement, using Lissajou figures. Enhancement of the display can be carried out using the Z-modulation input to obtain event markers, and this facility can also be used to

Field service tester

The MIT 3 is compact and is capable of testing most IC families including LSI devices. Board tests are carried out by checking each IC through a specific device test pattern (DTP). Each pattern comprises a specific truth table depending on both the single IC and the logical network in which it is included. By using signal forcing techniques, each device is dynamically checked by comparing the logical configurations of its pins to the corresponding pins given by the truth table.

All controls and actuating commands are software generated and test programs are stored on ECMA standard magnetic cassette units. Typically, a C60 cassette can hold

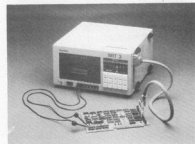

market

Elektor special offer

With Christmas now passed, many of our readers and their families will have products which need batteries or a low voltage supply for their operation. It is common knowledge that a battery is the most expensive form of energy currently available, a fact that does not seem to impress the children at all. The prices of batteries in particular seem to have escalated considerably lately, for example, a set of C batteries is now approximately £ 1.16 in the shops.

It is very wise not to rely on batteries at all if possible and the easy answer is the mains adaptor. These take the form of a power supply, including transformer, fitted into a case that plugs directly into the mains outlet socket. In general, these fall into two categories: the higher priced, better quality, British made product and the ultra cheap, often short lived and of dubious safety standard types of Far East origin. As usual, you get what you pay for!

But to celebrate the New Year, we have arranged for a selection of mains adaptors to be made available to readers direct from the manufacturers - at the very special price of £ 2.45!

The first model is a 'Universal Game Adaptor' which is designed to power the handheld electronic games or T.V. games so popular with the children. This adaptor is particularly useful for these products which would otherwise often only give 2 or 3 hours use out of a set of batteries. The adaptor will power virtually any equipment that uses a 6 or 9 volt battery and comes complete with '3-pin plug-in style housing', reversible polarity switch and 4-way output jack plug.

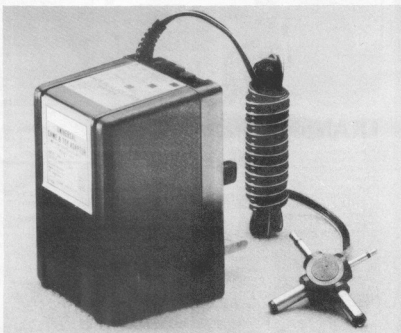

The second two models act as general purpose low voltage mains adaptors. The first model switches between 3, 4.5 or 6 volts at 200 mA, the second switches between 6, 7.5 or 9 volts at 300 mA. Again, both are made in the '3-pin plug-in style housing', are fitted with a

reversible polarity plug and socket and are supplied with the 4-way jack plug. All three models are fitted with a thermal overload safety trip. For ordering see the Adman advertisement on the following page. (2227 M)

market

Logic probe

Sabtronics International of Tama Florida recently announced the new LP-1 10 MHz Logic Probe for trouble-shooting logic circuits.

The LP-1 has LED display for logic 0 and 1 with switch selectable Thresholds to suit TTL or CMOS/MOS circuitry. The probe also has the useful ability to either detect and hold

pulses or 'glitches', or to stretch them.

Power for the LP-1 can usually be taken from the Vcc line of the unit under test - connection is by mini croc. clips, which are included.

Full interpretation instructions are printed on the reverse of the body of the LP-1.

Black Star Ltd.,
9a Crown Street,
St. Ives,
Huntingdon,
Cambs PE17 4EB,
Tel: (0480) 62440,
Telex: 32339.

(2180 M)

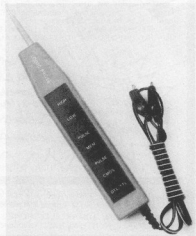

Computer controller for machines and robots

The new SNIPE Engineer is an exceedingly small, fully engineered computer. Although not much larger than a desk top calculator, the SNIPE Engineer has a retentive random access memory of some thirty two thousand bytes; greater than nearly any other micro computer available today.

If required it may be linked into any existing computer installation to become an intelligent terminal with even greater capability. The SNIPE Engineer has been designed to be programmed easily by someone without any previous computing experience.

Developed by the computer design company FELTEC, based in New Milton, Hampshire, the SNIPE Engineer can be used to control all

types of plant and machinery, from a single lathe to a complete production line.

The Engineer is one of the many models in the SNIPE family, which includes terminals and peripherals together with other mini-mini computers for specialised application. British designed and made the SNIPE range are all compact, robust and reliable.

Feltec,
Queensway,
New Milton,
Tel. (0425) 617477

(2177 M)



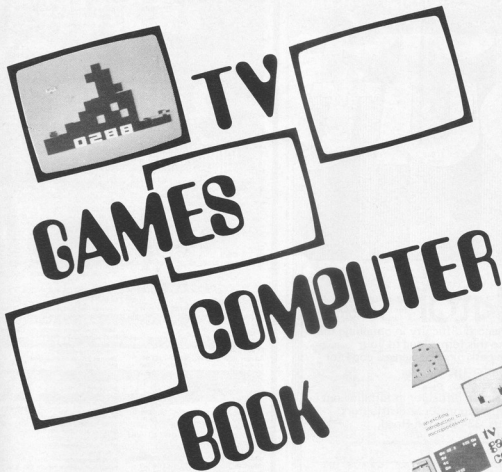

TV GAMES COMPUTER BOOK

**an exciting
introduction to
microprocessors**

The first acquaintance with microprocessors can be rather frightening. You are not only confronted with a large and complex circuit, but also with a new language: 'bytes', 'CPU', 'RAM', 'peripherals' and so on. Worse still, the finished article is a miniature computer and so you have to think up some sufficiently challenging things for it to do! This book provides a different — and, in many ways, easier — approach.

The TV games computer is dedicated to one specific task: putting an interesting picture on a TV screen, and modifying it as required in the course of a game. Right from the outset, therefore, we know what the system is intended to do. Having built the unit, 'programs' can be run in from a tape: adventure games, brain teasers, invasion from outer space, car racing, jackpot and so on. This, in itself, makes it interesting to build and use the TV games computer.

There is more, however. When the urge to develop your own games becomes irresistible, this will prove surprisingly easy! This book describes all the component parts of the system, in progressively greater detail. It also contains hints on how to write programs, with several 'general-purpose routines' that can be included in games as required. This information, combined with 'hands-on experience' on the actual unit, will provide a relatively painless introduction into the fascinating world of microprocessors!

£ 5.00 — Overseas £ 5.25
ISBN 0-905705-08-4

ELEKTOR BOOK SERVICE

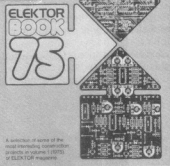
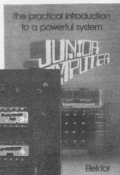
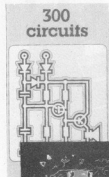

JUNIOR COMPUTER BOOK 1 — for anyone wishing to become familiar with (micro)computers, this book gives the opportunity to build and program a personal computer at a very reasonable cost.

Price — UK £ 4.25 Overseas £ 4.50

JUNIOR COMPUTER BOOK 2 — follows in a logical continuation of Book 1, and contains a detailed appraisal of the software. Three major programming tools, the monitor, an assembler and an editor, are discussed together with practical proposals for input output and peripherals.

Price — UK £ 4.75 Overseas £ 5.00

JUNIOR COMPUTER BOOK 3 — the next step, transforming the basic, single-board Junior Computer into a complete personal computer system.

Price — UK £ 4.75 Overseas £ 5.00

300 CIRCUITS for the home constructor — 300 projects ranging from the basic to the very sophisticated.

Price — UK £ 3.75 Overseas £ 4.00

DIGIBOOK — provides a simple step-by-step introduction to the basic theory and application of digital electronics and gives clear explanations of the fundamentals of digital circuitry, backed up by experiments designed to reinforce this newly acquired knowledge. Supplied with an experimenter's PCB.

Price — UK £ 5.00 Overseas £ 5.25

FORMANT — complete constructional details of the Elektor Formant Synthesiser — comes with a FREE cassette of sounds that the Formant is capable of producing together with advice on how to achieve them.

Price — UK £ 4.75 Overseas £ 5.00

SC/MPUTER (1) — describes how to build and operate your own microprocessor system — the first book of a series — further books will show how the system may be extended to meet various requirements.

Price — UK £ 3.95 Overseas £ 4.20

SC/MPUTER (2) — the second book in the series. An updated version of the monitor program (Elbug II) is introduced together with a number of expansion possibilities. By adding the Elektor terminal to the system described in Book 1 the microcomputer becomes even more versatile.

Price — UK £ 4.25 Overseas £ 4.50

BOOK 75 — a selection of some of the most interesting and popular construction projects that were originally published in Elektor issues 1 to 8.

Price — UK £ 3.75 Overseas £ 4.00

TV GAMES COMPUTER — this book provides a different — and, in many ways, easier — approach to microprocessors. The TV games computer is dedicated to one specific task, as the name suggests. This provides an almost unique opportunity to have fun while learning!

Price — UK £ 5.00 Overseas £ 5.25

When ordering please use the Elektor Readers' Order Card in this issue (the above prices include p. & p.)

THE ELEKTOR TALKING BOARD

The complete kit of parts for the Talking Board is available **now**

£76.00

including VAT



The kit for the Talking Boards has been produced for the project described in last month's of Elektor.

Features of the Talking Board include:
single board construction
expandable vocabulary
low power consumption
self contained memory

Send cheque or postal order to Crestway Electronics Ltd., write or ring with your ACCESS account no. (do not send your card). All our prices include VAT and carriage.
Orders under £10 please add £1 handling charge.
24 hour answering service on 0483 893236.
Crestway Electronics Ltd., Woodhill Lane, Shamley Green, near Guildford, Surrey

CRESTLEK KITS

Ioniser (9823) Negative	£ 12.50
Aerial Booster (80022A)	£ 6.00
U.H.F. T.V.	£ 6.00
Aerial Booster (80022B)	£ 6.00
V.H.F. F.M.	£ 6.00
Metal Detector	
(82021)	£ 91.95
TV Games extension	
(81143)	£ 52.00
Disco light controller	
(81155)	£ 12.50
EPROM programmer	
(81594)	£ 11.00
Teletext decoder	
(82025)	£ 137.00
The Elektor Mini Organ	
(82020)	£ 87.00
Electronic Gong	
(82046)	£ 15.00
Reprints of any Elektor article supplied with kits at 80 p	

TMS 5100

CrestWay
ELECTRONICS

WOODHILL LANE,
SHAMLEY GREEN,
near GUILDFORD,
SURREY.

Telephone 0483 893236

MAPLIN make it easy...



in
SOUTHEND
284 London Road
Westcliff-on-Sea
Essex
Tel: (0702) 554000
(Closed Mondays)



in
HAMMERSMITH
159-161 King Street
Hammersmith
London W6
Tel: 01-748 0926
(Closed Mondays)

For personal service visit one of our stores.
Our new store at Hammersmith is conveniently situated near the end of the M4 and the North and South Circular Roads.
There is excellent street parking on meters a few steps away and Hammersmith Underground Station is nearby. Call in and see us soon.



in our
CATALOGUE

320 big pages packed with data and pictures of over 5,500 items

Over 100,000 copies sold already!
Don't miss out on your copy.

On sale now in all branches
WH Smith price £1.

In case of difficulty check the coupon below.

make it easy... with MAPLIN

The
Maplin Matinée
Amazing value for only £299.95 plus £99.50 for cabinet if required (carriage extra)

Easy to build, superb specification. Comparable with organs selling for up to £1,000. Send for our new book giving full construction details, order as XH55K price £ 2.50 inclusive.



by
MAIL ORDER

A fast service you can rely on

- * Same day service on in-stock lines
- * Very large percentage of our stock lines in stock
- * All prices include VAT
- * Large range of all the most useful components
- * First class reply, paid envelope with every order
- * Quality components—no rejects—no re-marks
- * Competitive prices
- * Your money is safe with a reputable company

On price, service, stock, quality and security it makes sense now more than ever to make **maplin** your first choice for components every time!

Post this coupon now.

E 182

Please send me a copy of your 320 page catalogue. I enclose £1.25 (incl. 25p p&p). If I am not completely satisfied I may return the catalogue to you and have my money refunded. If you live outside the U.K. send £1.68 or 12 International Reply Coupons.

Name: _____

Address: _____

MAPLIN ELECTRONIC SUPPLIES LTD.

All mail to: P.O. Box 3, Rayleigh, Essex SS6 8LR. Tel: Southend (0702) 554155 Sales: (0702) 552911