

up-to-date electronics for lab and leisure

ELEKTOR 21

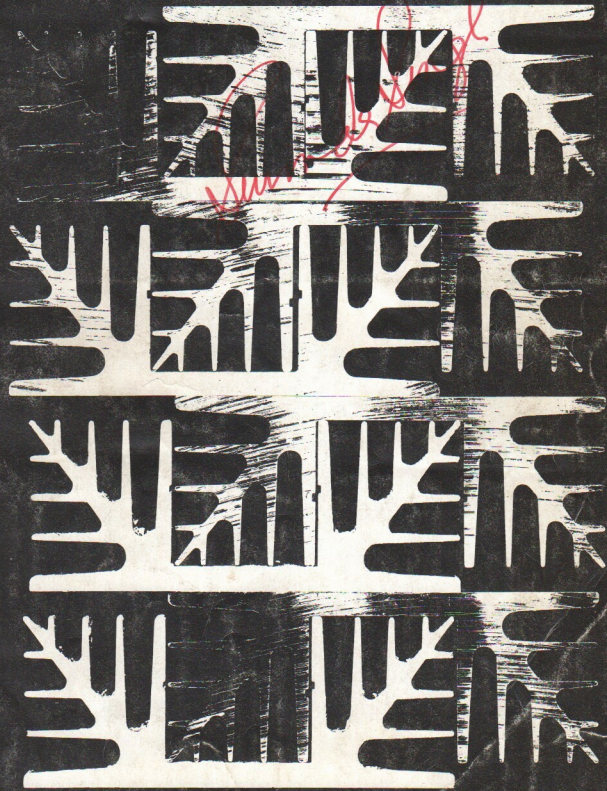

January 1977 45p

ELEKTOR

DECODER

Editor : W. van der Horst
Deputy editor : P. Holmes
Technical editors : J. Barendrecht
 G.H.K. Dam
 E. Krempelsauer
 G.H. Nachbar
 Fr. Scheel
 K.S.M. Walraven
Art editor : C. Sinke
Subscriptions : Mrs. A. van Meyel

UK editorial offices, administration and advertising:
 6 Stour Street, Canterbury, CT1 2XZ.
 Tel. Canterbury (0227) - 54430. Telex: 965504.
 Bank: Midland Bank Ltd Canterbury A/C no. 11014587,
 Sorting code 40-16-11, giro no. 3154254

Assistant Manager and Advertising : R.G. Knapp
 Editorial : T. Emmens

Elektor is published monthly on the third Friday of each month, price 45 pence. Please note that number 27/28 (July/August) is a double issue, 'Summer Circuits', price 90 pence. Single copies (including back issues) are available by post from our Canterbury office to UK addresses and to all countries by surface mail at £ 0.60. Single copies by air mail to all countries are £ 0.95. Subscriptions for 1977 (January to December inclusive): to UK addresses and to all countries by surface mail: £ 6.25, to all countries by air mail £ 11.---. All prices include p & p.

Change of address. Please allow at least six weeks for change of address. Include your old address, enclosing, if possible, an address label from a recent issue.

Letters should be addressed to the department concerned:
 TC = Technical Queries, ADV = Advertisements, SUB = Subscriptions; ADM = Administration; ED = Editorial (articles submitted for publication etc.); EPS = Elektor printed circuit board service. For technical queries, please enclose a stamped, addressed envelope.

The articles published are for domestic use only. The submission of designs or circuits to Elektor implies permission to the publishers to alter and translate the text and design, and to use the contents in other Elektor publications and activities. The publishers cannot guarantee to return any material submitted to them. All drawing, photographs, printed circuit boards and articles published in Elektor are copyright and may not be reproduced or imitated in whole or part without prior written permission of the publishers.

Patent protection may exist in respect of circuits, devices, components etc. described in this magazine. The publishers do not accept responsibility for failing to identify such patent or other protection.

National advertising rates for the English edition of Elektor and/or international advertising rates for advertising at the same time in the English, Dutch and German issues are available on request.

Distribution: Spotlight Magazine Distributors Ltd, Spotlight House 1, Bentwell Road, Holloway, London N7 7AX.

Copyright © 1977 Elektor publishers Ltd - Canterbury.

Printed in the Netherlands.

What is a TUN?
 What is 10 n?
 What is the EPS service?
 What is the TQ service?
 What is a missing link?

Semiconductor types

Very often, a large number of equivalent semiconductors exist with different type numbers. For this reason, 'abbreviated' type numbers are used in Elektor wherever possible:

- '741' stands for μ A741, LM741, MC741, MIC741, RM741, SN72741, etc.
- 'TUP' or 'TUN' (Transistor, Universal, PNP or NPN respectively) stands for any low frequency silicon transistor that meets the specifications listed in Table 1. Some examples are listed below.
- 'DUS' or 'DUG' (Diode, Universal, Silicon or Germanium respectively) stands for any diode that meets the specifications listed in Table 2.
- 'BC107B', 'BC237B', 'BC547B' all refer to the same 'family' of almost identical better-quality silicon transistors. In general, any other member of the same family can be used instead. (See below.)

For further information, see 'TUP', 'TUN', 'DUG', 'DUS', 'Elektor 20, p. 1234.

Table 1. Minimum specifications for TUP (PNP) and TUN (NPN).

V _{CEO} , max	20V
I _C , max	100 mA
f _{fe} , min	100
P _T , max	100 mW
T _J , min	100 MHz

Some 'TUN's are: BC107, BC108 and BC109 families; 2N3656A, 2N3859, 2N3960, 2N3904, 2N3947, 2N4124. Some 'TUP's are: BC177 and BC178 families; BC179 family with the possible exception of BC159 and BC179; 2N2412, 2N3251, 2N3906, 2N4126, 2N4291.

Table 2. Minimum specifications for DUS (silicon) and DUG (germanium).

	DUS	DUG
V _R , max	25V	20V
I _F , max	100mA	35mA
I _R , max	1 μ A	100 μ A
P _{tot} , max	250mW	250mW
C _D , max	5pF	10pF

Some 'DUS's are: BA127, BA217, BA218, BA221, BA222, BA317, BA318, BAX13, BAY61, 1N914, 1N4148.

Some 'DUG's are: OA85, OA91, OA95, AA116.

BC107 (-8, -9) families:

- BC107 (-8, -9), BC147 (-8, -9), BC207 (-8, -9), BC237 (-8, -9), BC317 (-8, -9), BC347 (-8, -9), BC547 (-8, -9), BC171 (-2, -3), BC182 (-3, -4), BC382 (-3, -4), BC437 (-8, -9), BC414

BC177 (-8, -9) families:

- BC177 (-8, -9), BC157 (-8, -9), BC204 (-5, -6), BC307 (-8, -9), BC320 (-1, -2), BC350 (-1, -2), BC557 (-8, -9), BC251 (-2, -3), BC212 (-3, -4), BC512 (-3, -4), BC261 (-2, -3), BC416.

Resistor and capacitor values

When giving component values, decimal points and large numbers of zeros are avoided wherever possible. The decimal point is usually replaced by one of the following international abbreviations:

- p (pico-) = 10⁻¹²
- n (nano-) = 10⁻⁹
- μ (micro-) = 10⁻⁶
- m (milli-) = 10⁻³
- k (kilo-) = 10³
- M (mega-) = 10⁶
- G (giga-) = 10⁹

A few examples:
 Resistance value 2k7: this is 2.7 k Ω , or 2700 Ω .
 Resistance value 470: this is 470 Ω .

Capacitance value 4p7: this is 4.7 pF, or = 0.000 000 000 004 7 F...
 Capacitance value 10n: this is the international way of writing 10,000 pF or .01 μ F, since 1 n is 10⁻⁹ farads or 1000 pF.

Mains voltages

No mains (power line) voltages are listed in Elektor circuits. It is assumed that our readers know what voltage is standard in their part of the world!

Readers in countries that use 60 Hz should note that Elektor circuits are designed for 50 Hz operation. This will not normally be a problem; however, in cases where the mains frequency is used for synchronisation some modification may be required.

Technical services to readers

- **EPS service.** Many Elektor articles include a lay-out for a printed circuit board. Some - but not all - of these boards are available ready-stamped and predrilled. The 'EPS print service list' in the current issue always gives a complete list of available boards.

- **Technical queries.** Members of the technical staff are available to answer technical queries (relating to articles published in Elektor) by telephone on Mondays from 14.00 to 16.30. Letters with technical queries should be addressed to: Dept. TQ. Please enclose a stamped, self-addressed envelope, readers outside U.K., please enclose an IRC instead of stamps.

- **Missing link.** Any important modifications to, additions to, improvements on or corrections in Elektor circuits are generally listed under the heading 'Missing Link' at the earliest opportunity.

CONTENTS

Volume 3
Number 1

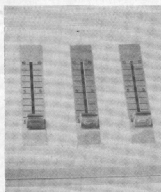

Despite its simple design the **stereo audio mixer** will accept inputs from microphone, magnetic cartridge, or 'flat' line sources.

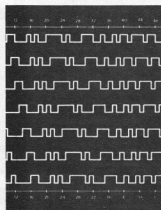

The **noise generator** described in this issue uses digital techniques to produce a pseudo-random binary noise signal. Suitable filtering converts this to analog 'white' or 'pink' noise.

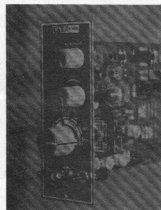

This photo of a **Y-preamp** illustrates the modular construction of the **Elektroscope**.

up-to-date electronics for lab and leisure
ELEKTOR 21

Not a microphotograph of snow crystals, but neatly packed heat-sinks!

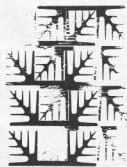

selektor	110
elektoracle	113
stereo audio mixer	114
This is a design for a simple but high-quality, portable, five-input, stereo mixer intended for use in discos or for tape recording.	
marbles	120
Playing marbles is still one of the most universal of childhood pleasures. In this modern day and age, it was only a question of time before some designer tried his hand at designing an electronic equivalent . . .	
noise generator	123
A digital method of generating so-called pseudo-random 'white' and 'pink' noise is described in this article and applied in a practical circuit.	
audio wattmeter — J. Jacobs	128
elektroscope (2)	130
A linear timebase and stable trigger circuits are essential to the operation of an oscilloscope. In this month's article the circuit of the timebase, trigger circuit, X and Y amplifiers, channel switches and Y-preamps are discussed.	
quadi-complimentary complemented	139
bi-fet opamps	140
Interesting results can often be obtained by using several different types of active device in one circuit. A relatively new example of this is the BI-FET opamp. It consists of JFETs and bipolar transistors on the same chip, and this could well give interesting results at a reasonable price.	
ic audio	142
In this article two completely different types of high-power audio ICs are discussed. To avoid confusion the article is split into two parts. The first part deals with hybrid power-integrated circuits while the second section deals with the TDA 2020 IC.	
the BF 494 — a case in point	148
transistors	149
market	150
linear ics, mos ics, ttl ics	157
tup-tun-dug-dus	160

elektor back issues are still available

This is a selection from the contents of the various issues:

number 1: @ 50 p

- tup-tun-dug-dus
- equa amplifier
- mos clock
- distortion meter
- tap sensor
- electronic loudspeaker
- steam whistle

number 2: @ 50 p

- mindrum
- universal display
- dil led probe
- tv sound
- big ben
- modulation systems
- how to gyrate

number 3: @ 50 p

- tap preamp
- pll systems
- fido
- time machine
- compressor
- disc preamp
- a/d converter
- led displays

number 4: @ 50 p

- tup-tun tester
- interference suppression in cars
- thief suppression in cars
- supplies for cars
- cybernetic beetle
- the moth
- quadro in practice

number 5: @ 85 p

'Summer Circuits' issue, with over 100 circuits: amplifiers, generators, dividers, universal frequency reference, improved 7-segment display, receivers, power supplies, rhythm generators, measuring equipment, etc.

number 6: @ 50 p

- edwin amplifier
- versatile digital clock
- phasing
- disco lights
- ota
- dual slope dvm
- car clock

numbers 7 and 8:

sold out

number 9: @ 55 p

- feedback pll for fm
- function generator
- racing car control
- simple mw receiver
- digital master oscillator
- pll-ic stereo decoder

number 10: @ 55 p

- call sign generator
- morse decoder
- speech processor
- morse typewriter
- digital wrist watch

number 11: @ 55 p

- tv tennis extensions
- ssb receiver
- tv sound front-end adapter
- dynamic noise limiter
- integrated voltage regulators

number 12: @ 55 p

- preco
- ic rhythm generator
- polaroid timer
- led meters
- stylus balance

number 13: @ 55 p

- integrated indoor fm aerial
- equin (2)
- digidisplay
- versatile logic probe

number 14: @ 55 p

- a.m. mains intercom
- fet probe
- vhf fm reception
- led light show
- digibell

number 15/16: @ 95 p

'Summer circuits' issue, with over 100 circuits

number 17: @ 55 p

- m.p.g. indicator
- ignition timing strobe
- car service meter
- windscreen wiper delay
- rev counter

number 18: @ 55 p

- time on tv
- score on tv
- loud mouth
- SQ decoder

number 19: @ 55 p

- albar
- metal detector
- calendar
- intercom
- signal horn
- pulse generator

number 20: @ 55 p

- thermometer
- snooze-alarm-radio-clock
- parking meter alarm
- elektor index 1976
- phasing and vibrato
- elektorscope
- sirens

Prices quoted @ U.K./
Surface rate.
Airmail add. 35 p

BOOK

75

Following the success of the many original and varied construction projects in Elektor magazine we are now publishing

BOOK 75.

Written and presented in Elektor's unique style its contents include:

versatile digital clock
mini hifi
tv tennis game
tunable aerial amplifier
disc preamp
universal frequency reference
time signal simulator
edwin amplifier, fido and

many
others

PLUS 'DATA SECTION' covering Elektor service to readers, LED DISPLAY MOS-ICS, TTL-ICS, OPAMPS, TRANSISTORS and TUP-TUN-DUS-DUG.

For ordering please use the postage paid order card in this issue.

STEREO AUDIO MIXER

This is a design for a simple but high-quality, portable, five-input, stereo mixer intended for use in discos or for tape recording. Despite its simple design the mixer will accept inputs from microphone, magnetic cartridge, or 'flat' line inputs.

The total current consumption is quite low, so the unit may be powered from batteries as well as its own, integral, mains power supply.

In the fields of application for which this mixer is intended it was felt that the cost, complexity and weight of such facilities as tone and balance controls were not justified. Such facilities are best left to the professional studio mixer.

A block diagram of one channel of the mixer is shown in figure 1. This is of course duplicated for the other channel. It can be seen that the first three inputs are each provided with a preamplifier,

and any or all of these preamplifiers can be constructed as either a disc or microphone preamp. The outputs of the preamplifiers feed into faders (gain controls). The two remaining inputs are intended to be fed from 'flat' sources such as tape, and these inputs are fed direct into the faders.

The outputs from all the faders are mixed (more properly 'summed') at the virtual earth input of the post amplifier, and the mixed output can then be fed

Specification	
Inputs.	Five (stereo) inputs, three microphone or magnetic cartridge, plus two line inputs.
Preamplifier gain.	Disc inputs x 80 (38 dB) Mic. inputs x225 (47 dB)
Post amplifier gain.	~ x1.25
Maximum input level (one input driven).	Disc 44 mV RMS Sine-wave into 47 k. Mic. 14 mV RMS Sine-wave into 47 k. Line 2.5 V RMS into 47 k.
Maximum output level	3.2 V RMS sinewave from 600 Ω
Frequency response	Line and Mic.: 20 Hz — 20 kHz (-2dB). Disc - RIAA equalisation correct to ± 1.5 dB.
Total harmonic distortion	Less than 0.1%
Signal to noise ratio	Better than 70 dB.

to the tape recorder, disco amplifier or whatever. The post amplifier, according to the whim of the individual constructor, may or may not be equipped with a master gain control.

Preamplifiers

Figure 2 is the complete circuit of one channel of the stereo mixer. The input preamplifier is constructed around T1 and T2, and is, of course, duplicated for inputs 2 and 3, though this is not shown in full. T1 functions as a voltage amplifier with a relatively high gain, and the noise figure is good due to the low collector current of approximately 86 μ A.

T2 also operates as a voltage amplifier, but since the output signal is taken from its collector, the collector resistor must be fairly low to obtain a reasonably low output impedance that will not be unduly loaded by the fader P1.

Negative feedback is provided from the collector of T2 to the emitter of T1 via an equalisation network connected between points X and Y.

The networks for disc and microphone inputs are shown at the bottom of figure 2. Note that for the disc preamp R3 is 470 Ω , and for the microphone input, 1k5.

The two line inputs require little comment, since they simply feed direct into the faders P4 and P5. It is, of course, perfectly possible to convert any or all of the preamp inputs to line inputs simply by omitting the preamp components and joining points A and B.

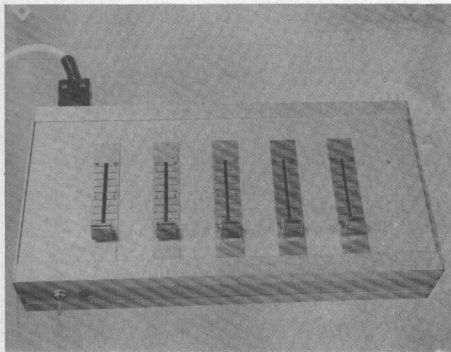

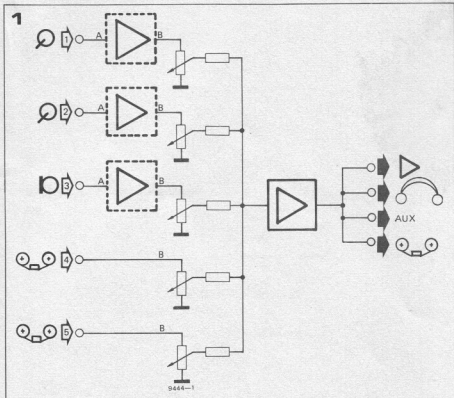
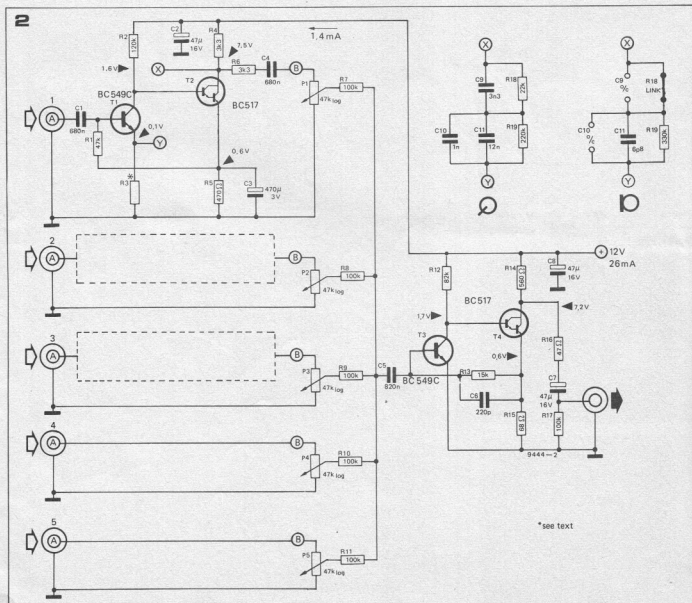
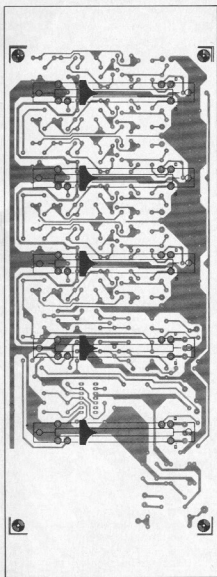

figure 1. Block diagram of one channel of the stereo mixer.

figure 2. Complete circuit of one channel of the stereo mixer.



* see text



Photos 1 and 2. Showing how the potentiometers may be mounted direct on the back of the p.c. board.

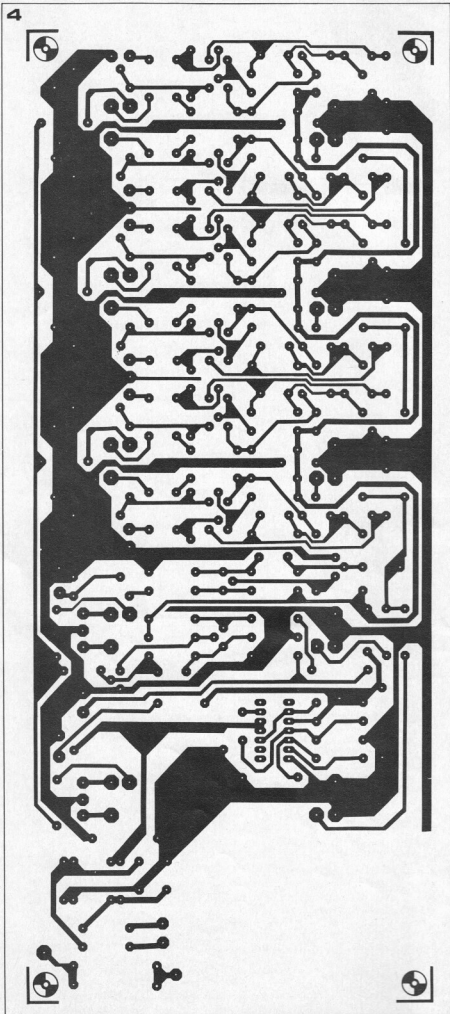
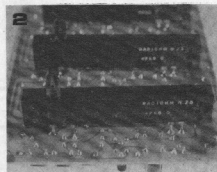

5

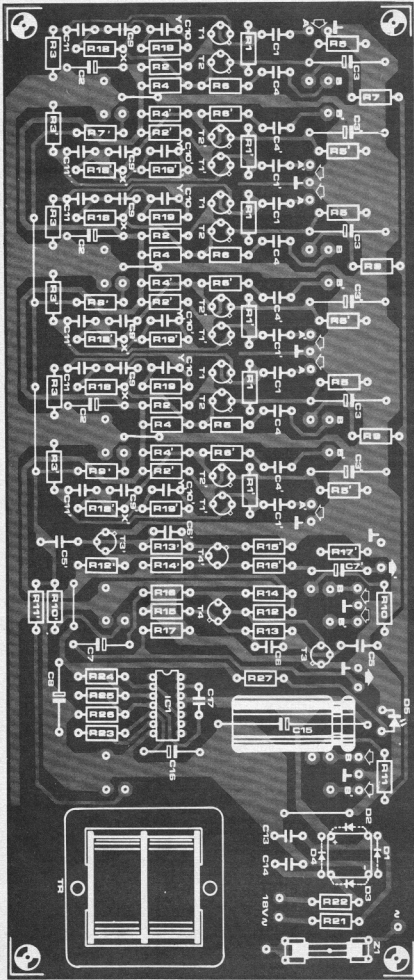

Parts list

Resistors:

R1 = 47 k
 R2 = 120 k
 R3 = 470 Ω DISC
 1k5 MIC
 R4, R6, R25 = 3k3
 R5 = 470 Ω
 R7 ... R11, R17 = 100 k
 R12 = 82 k
 R13 = 15 k
 R14 = 560 Ω
 R15 = 68 Ω
 R16 = 47 Ω
 R18, R19 = see text
 R21, R22, R24 = 10 Ω
 R23 = 1k8
 R26 = 4k7
 R27 = 820 Ω

Capacitors:

C1, C4 = 680 n
 C2, C7, C8 = 47 μ /16 V
 C3 = 470 μ /3 V
 C5 = 820 n
 C6 = 220 p
 C9, C10, C11 = see text
 C13, C14 = 47 n
 C15 = 470 μ /40 V
 C16 = 10 μ /10 V
 C17 = 100 p

Semiconductors:

T1, T3 = BC549 C
 T2, T4 = BC517 (Darlington)
 D1 ... D4 = 4 x 1N4001 or
 bridge rectifier B 40 C 400
 D5 = LED
 IC1 = 723 DIL

Miscellaneous:

Tr = 15 - 18 V/50 mA
 (minimum) transformer
 Z1 = 50 mA fuse
 P1 ... P5 = 47 k log. stereo-
 slider potentiometer

figure 4. Printed circuit board for the mixer and power supply (EPS 9444).

figure 5. Component layout for figure 4.

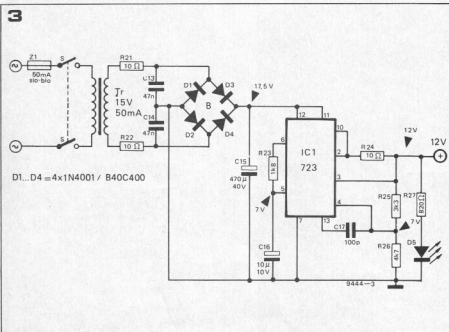
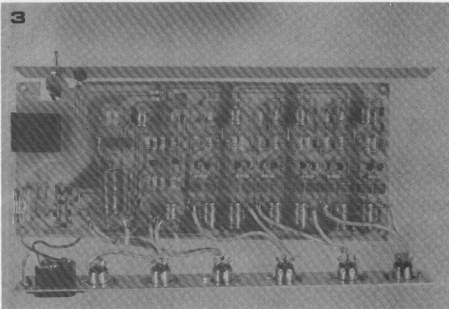

The outputs of the faders are connected to the input of the post amplifier via mixing resistors R7 to R11. To avoid any unwanted interaction between the input signals the a.c. voltage at the mixing mode must be zero. This is basically what is meant by the term 'virtual earth': although the amplifier input is not actually grounded its input voltage is always very small. In other words the amplifier has a very low input impedance.

This result is achieved by applying a large degree of negative feedback from the emitter of T4 to the base of T3. When one of the input signals swings positive this will attempt to force more base current into T3. The collector of T3, and hence the emitter of T4, will swing negative until the current through R13 is the same as that through the input resistor (neglecting T3 base current), and the a.c. voltage at the input node will remain zero.

The overall gain of the post amplifier is the product of the gain of T3 (with feedback) and the gain of T4. This is

given by

$$\frac{R_{13}}{R_{in}} \times \frac{R_{14}}{R_{15}}$$

i.e. about 1.25; R_{in} is one of the resistors R7...R11.

The output of the post amplifier is taken from the collector of T4, the output impedance being 600 Ω . If desired R17 may be replaced by a master fader control, though in many cases this will not be necessary as the succeeding equipment will have gain controls.

Power Supply

The power supply is based on a 723 IC regulator, with its output set to 12 V, and this is more than adequate to supply the small current taken by the mixer without the need for heatsinks or external transistors. Due to tolerances in the 723's internal reference voltage the output voltage may not be precisely

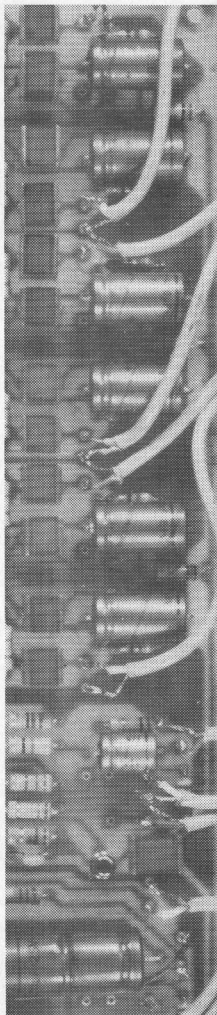

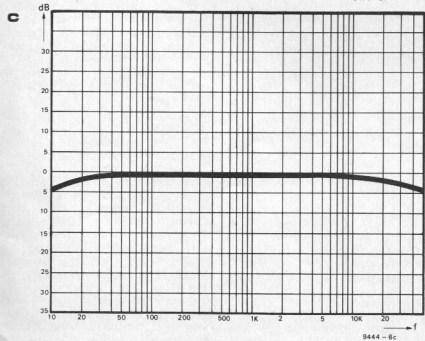
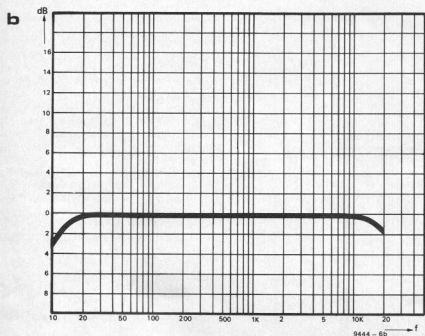
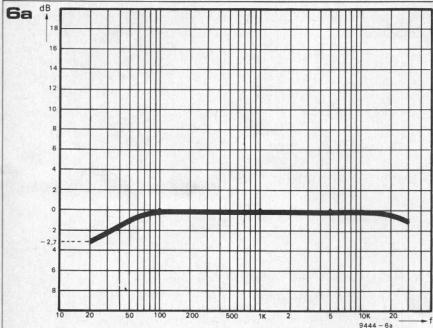

Photo 3. The completed mixer in its case with the lid removed.

figure 3. Power supply for the stereo mixer.

figure 6. Frequency response of the mixer for the disc (fed via reciprocal RIAA network) microphone and line inputs.

12 V, but this is no cause for concern.

Construction

A printed circuit board and component layout for the mixer are given in figures 4 and 5. It will be seen that the input preamplifiers are duplicated in three pairs, each numbered identically, the right channel components being identified by an apostrophe. When ordering components it must be remembered that for the input preamps 6 off are required of each component, and for the post amplifier, 2 off.

For the faders, slider pots of the RS Components, Doram or Radiohm type should be used, as these may be mounted direct on the back of the p.c. board as shown in photos 1 and 2. It should be noted that the sliders for the line inputs are mounted on the back of the board adjacent to the power supply, on either side of IC1. Provision is made for mounting the mains transformer on the p.c. board, and this should prove satisfactory. However, if hum on the inputs is a problem it may be necessary to mount the transformer remote from the board.

Input and output wiring should conform to normal audio practice, care being taken to avoid earth loops.

Performance and Applications

Figures 6a, b, and c show respectively the frequency response of the disc, microphone and line inputs. It would have been extremely easy to have extended the h.f. response into the MHz region, but bearing in mind the probable applications it was felt that this was simply inviting problems due to radio breakthrough and instability, especially in such applications as discos and tape recording where the layout of leads may be somewhat haphazard. For this reason the response is confined strictly to the audio spectrum by the inclusion of C6, and C12 in the microphone preamp.

The mixer may be used with most types of magnetic cartridge and dynamic microphone, as well as with high-level sources such as cassette decks, tape decks and tuners. With high output cartridges it may be found that overloading of the preamp occurs, and the cure for this is simply attenuation of the cartridge output so that the preamp reaches maximum output only on peaks.

MARBLES

Playing marbles is still one of the most universal of childhood pleasures. In this modern day and age, it was only a question of time before some designer tried his hand at designing an electronic equivalent . . .



There are any number of different games that can be played with marbles. This electronic version simulates one particular variant: the object is to roll the marble towards a wall, and the person whose marble ends up closest to the wall is the winner. It doesn't matter whether it bounces off the wall first — the only thing that counts is the final position.

In the electronic version, the rolling marble is simulated by an up/down counter driving a column of LEDs (figure 1). It is 'rolled' by pressing the start button; the length of time that the button is depressed corresponds to the initial speed and this is where some skill is called for. Initially, LED 1 is on. As soon as the button is pushed this LED goes out and LED 2 lights up; then this, in turn, goes out and LED 3 lights up and so on. The speed with which the point of light moves up the column depends on how long the start button is held down.

Since real marbles don't keep rolling at the same speed all the way, some 'friction' has been built in: the point of light slows down gradually until it finally comes to a standstill. One LED is now on, corresponding to the final position of the marble. The three LEDs across the top of the column are the 'wall' against which the 'marble' bounces, so the object of the exercise is to end up with LED 16 lit up.

Pushing the reset button resets the counter, so that LED 1 is lit up ready for the next try.

The circuit

The basic operation of the circuit is as follows. When the start button is depressed an oscillator is started. The initial frequency depends on how long the button is held down, and after it is released the frequency of the oscillator gradually decreases until it finally stops. The output from the oscillator drives the up/down counter (see figure 1). The four-bit output from this counter is passed to a decoder which drives the LEDs.

The complete circuit is shown in figure 2a and 2b. T1 and T2 are the oscillator — in this case, a fairly standard multivibrator circuit. The frequency is

1

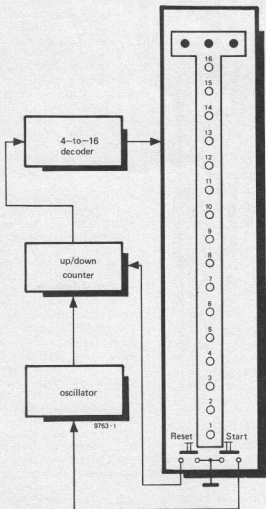

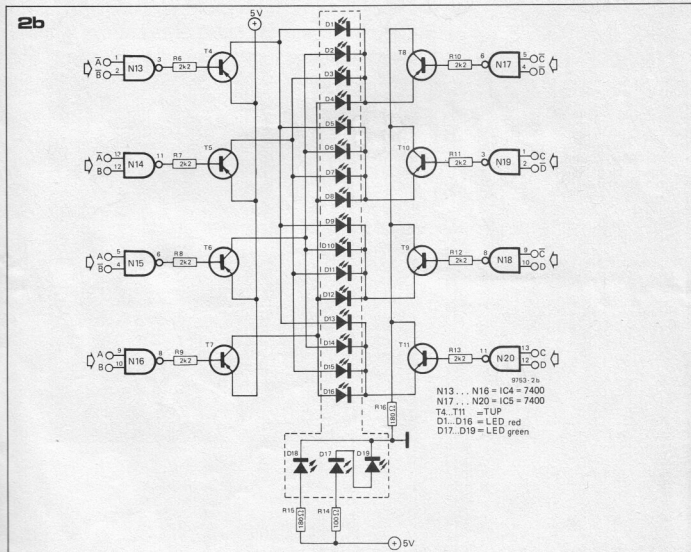
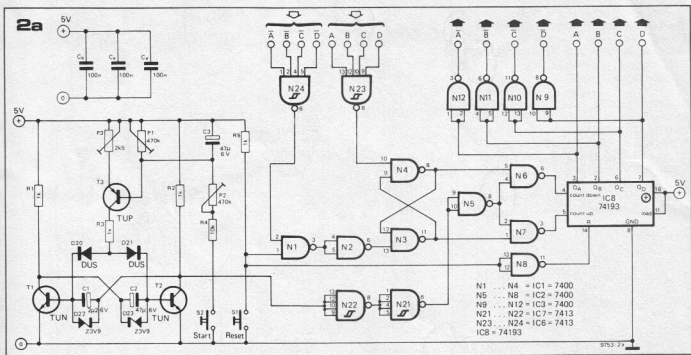

Figure 1. Block diagram of 'electronic marbles', showing the layout of the LEDs.

Figure 2. The complete circuit diagram. Figure 2a is the oscillator and counter with associated logic; figure 2b is the decoder/driver.

determined by the setting of current source T3, or, to be more precise, on the base voltage of this transistor. When the start button is depressed C3 charges up. The higher the voltage across C3, the higher the frequency of the oscillator - and the longer it will take for

the capacitor to discharge.

The rate of charge of C3 can be preset with P2, so this sets the ratio between the initial speed and the length of time the button is held down. The discharge time depends on the setting of P1 - the 'friction' adjustment. P3 is the actual

'marble speed' control.

The output at the collector of T2 is not a particularly good square-wave, so it is 'polished up' by two Schmitt-triggers (N22 and N21) in cascade.

The up/down counter (IC8) has two inputs, one for 'count up' and one for 'count down'. Which of these inputs is driven by the oscillator depends on the state of the RS-flip/flop N3/N4.

When the output of N3 is at logic '1', N7 is freed and the counter counts up; when the output of N4 is 'high', the counter counts down.

When the reset button is depressed, the flip/flop is reset to the condition where the output of N3 is '1'. The counter will now count up until it reaches the maximum count (1111). At this point the output of N23 changes from '1' to '0'. This low-level input to N4 sets the flip/flop. The output of N4 is now 'high' and the counter counts down. When it reaches the lowest count (0000) the output of N24 goes 'low', resetting the flip/flop again so that the counter starts to count up again. The result of all this is that the counter counts up and down continuously until the oscillator stops.

The '4-to-16 decoder' and the LED drivers are shown in figure 2b. The number of components required has been reduced by incorporating two tricks: the LED drivers are part of the decoder, and the decoder actually consists of two '2-to-4' decoders instead of one '4-to-16' type. For a particular LED to light up, the left-hand transistor connected to its anode and the right-hand transistor connected to its cathode must both be conducting. The left-hand transistors are driven by the A and B outputs of the counter, as decoded by N13 through N16, and the right-hand transistors are driven by the C and D outputs through a similar decoder (N17 through N20).

The transistors are connected to the LEDs in such a way that the final result is the desired '4-to-16' decode. To give one example, if the counter output is '1100' (A = 0, B = 0, C = 1 and D = 1) corresponding to a count of 12, the thirteenth LED should light up — remember that '0000' corresponds to LED 1! In this case the output of N13 will be low, turning on T4. At the same time the output of N20 will also be low, turning on T11. T4 is connected to D1, D5, D9 and D13, whereas T11 drives D13, D14, D15 and D16. The only LED connected to both transistors is D13, so it lights up, as intended.

LEDs D17, D18 and D19 are the 'wall'.

■

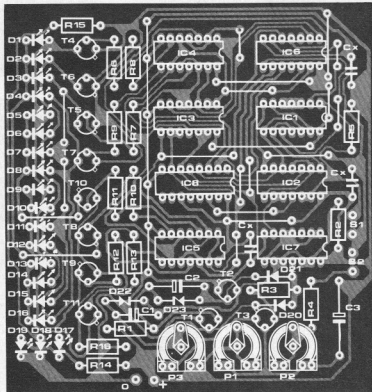
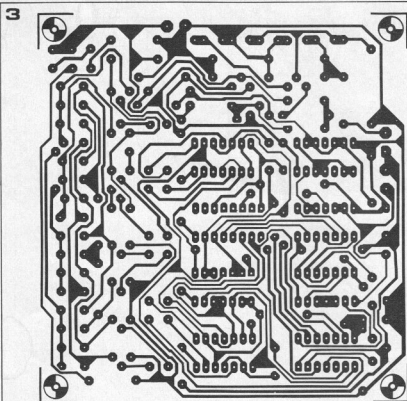

Resistors:

R1, R2, R3, R5 = 1 k
R4 = 10 k
R6 ... R13 = 2k2
R14 = 100 Ω
R15, R16 = 180 Ω
P1, P2 = 470 k preset
P3 = 2k5 preset

Capacitors:

C1 = 2μ2/6 V
C2, C3 = 47 μ/6 V
Cx = 100 n (3x)

Semiconductors:

IC1 ... IC5 = 7400
IC6, IC7 = 7413
IC8 = 74193
T1, T2 = TUN
T3 ... T11 = TUP
D1 ... D16 = LED red
D17 ... D19 = LED green
D20, D21 = DUS
D22, D23 = 3V9/400 mW zener

Sundries:

S1, S2 = single-pole pushbutton

Table 1

$\frac{t}{T_k}$	Q0	Q1	Q2	Q3	Q4	Q5	Q6	decimal
0	0	1	1	1	1	1	1	63
1	0	0	1	1	1	1	1	62
2	0	0	0	1	1	1	1	60
3	0	0	0	0	1	1	1	56
4	0	0	0	0	0	1	1	48
5	1	0	0	0	0	0	1	32
6	0	1	0	0	0	0	0	1
7	0	0	1	0	0	0	0	2
8	0	0	0	1	0	0	0	4
9	0	0	0	0	1	0	0	8
10	1	0	0	0	0	1	0	16
11	1	1	0	0	0	0	1	33
12	0	1	1	0	0	0	0	3
13	0	0	1	1	0	0	0	6
14	0	0	0	1	1	0	0	12
15	1	0	0	0	1	1	0	24
16	0	1	0	0	0	1	1	49
17	1	0	1	0	0	0	1	34
18	0	1	0	1	0	0	0	5
19	0	0	1	0	1	0	0	10
20	1	0	0	1	0	1	0	20
21	1	1	0	0	1	0	1	41
22	1	1	1	0	0	1	0	19
23	1	1	1	1	0	0	1	39
24	0	1	1	1	1	0	0	15
25	1	0	1	1	1	1	0	31
26	0	1	0	1	1	1	1	60
27	0	0	1	0	1	1	1	58
28	0	0	0	1	0	1	1	52
29	1	0	0	0	1	0	1	40
30	1	1	0	0	0	1	0	17
31	1	1	1	0	0	0	1	35
32	0	1	1	1	0	0	0	7
33	0	0	1	1	1	0	0	14
34	1	0	0	1	1	1	0	28
35	0	1	0	0	1	1	1	57
36	0	0	1	0	0	1	1	50
37	1	0	0	1	0	0	1	36
38	0	1	0	0	1	0	0	9
39	1	0	1	0	0	1	0	18
40	1	1	0	1	0	0	1	37
41	0	1	1	0	1	0	0	11
42	1	0	1	1	0	1	0	22
43	1	1	0	1	1	0	1	45
44	1	1	1	0	1	1	0	27
45	0	1	1	1	0	1	0	55
46	1	0	1	1	1	0	1	46
47	1	1	0	1	1	1	0	29
48	0	1	1	0	1	1	1	59
49	0	0	1	1	0	1	1	54
50	1	0	0	1	1	0	1	44
51	1	1	0	0	1	1	0	25
52	0	1	1	0	0	1	1	51
53	1	0	1	1	0	0	1	38
54	0	1	0	1	1	0	0	13
55	1	0	1	0	1	1	0	26
56	0	1	0	1	0	1	1	53
57	1	0	1	0	1	0	1	42
58	1	1	0	1	0	1	0	21
59	1	1	1	0	1	0	1	43
60	1	1	1	1	0	1	0	23
61	1	1	1	1	1	0	1	47
62	1	1	1	1	1	1	0	31
63	0	1	1	1	1	1	1	63

Table 1. The truth table for one complete cycle of a 6-bit shift register with EXOR-feedback from the outputs Q5 and Q6.

Figure 3. The frequency spectrum of pseudo random binary noise.

Figure 4. The pulse diagram corresponding to table 1.

Figure 5. The circuit diagram of the white noise generator. N9 . . . N29, N3 and N4 are needed to terminate the 'all-zero' output condition.

3

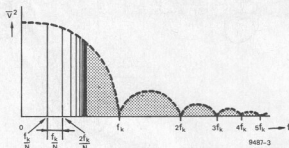

system. The noise signal at the output of this filter is called *pink noise*.

How do we make noise?

This may sound like a ridiculous question considering the fact that the major problem in audio is usually how to get rid of it. However, what is meant is: how can we make noise with the greatest possible spectral purity? And that is something quite different. White noise can be derived from the noise produced by the BE junction of a transistor that is reverse-biased into the break-down region. This produces a very low-level signal which must be amplified, and the $\frac{1}{f}$ - noise of the amplifier

may be a problem. The signal-to-noise ratio of the amplifier must be very high. An even greater problem is that this type of noise is of thermal origin. The noise (r.m.s. value) is sensitive to temperature variations.

Pseudo random noise

Pseudo random noise, unlike random noise, consists of a periodical repetition of a specific random noise pattern. As an example, imagine that a true random noise signal is recorded on a closed loop of tape. When this tape is played back,

the output will be pseudo random noise. An advantage of using pseudo random noise as a test signal is that the measuring time need not be infinitely long. (Theoretically, this is a requirement when measuring with true random noise . . .).

Pseudo random binary noise

It is not too difficult to generate pseudo random noise using digital techniques. A pseudo random binary noise signal is passed through a suitable low pass filter to give the analog noise required. It will be shown that both the binary and the analog noise signal are sufficiently 'noisy'.

The cycle character of pseudo random noise results in a repetition rate T_0 of the analog noise (T_0 is the period of one noise pattern), and as a cycle time T_0 for the binary noise.

Figure 2 gives the block diagram of a binary pseudo random noise generator. The n flipflops $FF_1 \dots FF_n$ are cascaded thus forming an n -bit shift register.

The register is shifted by a clock pulse with period time T_k and frequency f_k . Since the continuous clocking of only 'zeros' or 'ones' into the shift register will certainly not lead to the required

4

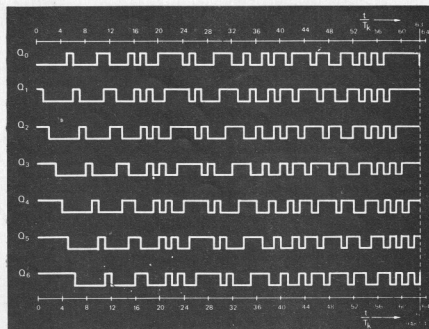

6

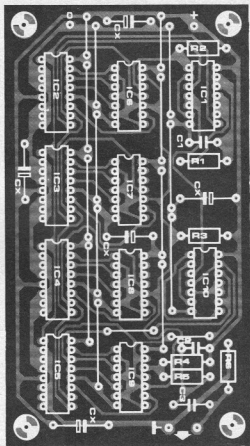
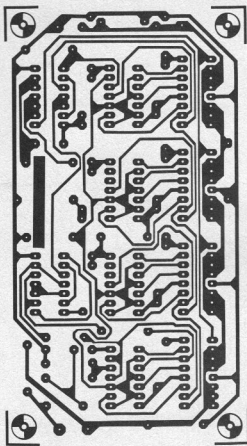

The second column lists the EXOR information Q_0 which is fed to the first flipflop. The next six columns indicate the output from the 6 flipflops and the last column gives the decimal value of the 6-bit binary number, where Q_1 represents the LSB and Q_6 the MSB. Table 1 and the pulse diagram of figure 4 both clearly illustrate that the circuit is basically a shift register: the bits move one step to the right at each clock pulse. After 63 clock pulses the register is back at its initial state.

The pseudo random character of the output states is expressed as follows:

1. Of the total of N clock periods in one cycle, any particular Q output is 'high' during $(N+1) : 2$ periods, and low during $(N-1) : 2$ clock periods. This is because the zero state of the register is excluded. As n , and with it N , increases, the chance of a logic '0' approaches the chance of a logic '1' (50%).
2. If by trajectory we mean the number of clock periods within which the logic state of a particular Q output does not change, there are $(N+1) : 2$ trajectories in each complete cycle. Half of these trajectories are equal to one clock period; one quarter are equal to two clock periods, one eighth are equal to three clock periods, and so on. There is also one trajectory that is equal to n clock periods.
3. The number of trajectories of each length is equally divided over trajectories with logic '0' and ditto with logic '1'; the

trajectory of $n-1$ clock periods occurs in '0' only and the trajectory of n clock periods occurs in '1' only. These rules can be verified by means of table 1 and figure 4.

The design described here (figure 5) uses a 20-bit shift register with EXOR feedback from the outputs Q_{17} and Q_{20} . The cycle duration is 1,048,575 (see table 2). It would be possible to set up the truth table, as was done for the 6-bit register in table 1. However, such a truth table would comprise 23 columns instead of the 9 in table 1, meaning that it would be nearly three times as wide. The number of lines becomes 1,048,576 instead of the 64 of table 1, which means that the truth table becomes more than 16,000 times as long. Since table 1 occupies a full column of an Elektor page, this truth table would cover over 16,000 pages. So as not to make this article unnecessarily long, we have refrained from publishing the table in question. . . .

The cycle time T_0 of the above-described shift register counter with maximum cycle time can be extended considerably. At $n = 33$ (see table 2) and a clock pulse frequency of 10 MHz ($T_k = 0.1 \mu s$) it takes about 859 seconds (almost 15 minutes) before the cycle is completed. If, instead, a clock period of 1 second is used ($f_k = 1 \text{ Hz}$), the cycle time would be equal to about 8.6×10^9 seconds, considering that one year takes on average $60 \times 60 \times 24 \times 365.25 = 31,558 \times 10^6$ seconds, it would take

Parts list

Resistors

R1 = 390 Ω
R2, R3, R4, R5 = 1 k
R6 = 100 k

capacitors

C1 = 4n7
C2 = 6n8
C3 = 1 μ
C4 = 2 μ 2/16 V

semiconductors

IC1 = 74132
IC2, IC3, IC4, IC5 = 7496
IC6, IC7, IC8, IC9 = 7405
IC10 = 7400

Table 2. A survey of possibilities and connections for feedback shift registers with bit lengths ranging from 3 to 33.

Figure 6. The printed circuit board and component layout for the circuit of figure 5.

Figure 7. The circuit of a passive low-pass filter with a slope of 3 dB per octave. If white noise is applied to this filter, pink noise is produced at the output.

Figure 8. Frequency response of the filter of figure 7.

over 270 years to complete the cycle! Chances are that this exceeds the life of the hardware constituting the equipment.

The frequency spectrum

Figure 3 is an attempt to illustrate the power density spectrum of the pseudo random binary noise on the Q-outputs. This spectrum is not continuous, but consists of an infinite number of lines. The spacing between the lines (frequency difference) equals

$$f_0 = \frac{1}{T_0} = \frac{f_k}{N},$$

so that the spectrum consists of the frequencies

$$0, \frac{f_k}{N}, \frac{2f_k}{N}, \frac{3f_k}{N}, \text{ etc.}$$

The envelope of the frequency spectrum varies according to the function

$$\left(\frac{\sin x}{x}\right)^2,$$

x being related to the ratio between f and f_k . The spectrum contains no component for f_k and multiples thereof. It can be calculated that the power spectrum has dropped 3 dB at a frequency equal to 0.45 x the clock frequency f_k .

The spectrum is equivalent to a band-limited white noise signal (within 0.1 dB) for frequencies between 0 and $f_k/4\pi$ Hz. To be on the safe side, the band can be limited to

$$f_g = \frac{f_k}{20}.$$

For the final design f_g was set at about 25 kHz, so that a clock frequency f_k of about 500 kHz is needed. Since N equals 1,048,575, the distance between the lines of the frequency spectrum is slightly less than 0.5 Hz. The cycle time T_0 is about 2 seconds.

The circuit

The final circuit is shown in figure 5. Schmitt trigger gates N1 and N2 are used as a clock pulse generator which runs at 500 kHz. This drives the clock inputs (pin 1) of four 5-bit shift registers IC2 . . . IC5; these are cascaded to form the 20-bit shift register.

The EXOR function is achieved by means of the gates N5 . . . N8. Feedback is taken from Q17 and Q20, in accordance with table 2. The EXOR feedback signal (the output of N5, Q₀) is fed to the input of the shift register via inverter N3 and gate N4.

Point 1 of N4 is normally 'high' so that the feedback signal arrives at point 9 of IC2. However, if all 20 Q-outputs of IC2 . . . IC5 are 'low', the input of inverter N29 goes high. As a result point 1 of N4 goes low. A '1' is now fed into the register so that the condition of twenty zeros, which might occur due to faults, is terminated.

The output is fed through a low-pass filter (R4, R5, C2) with a cut-off frequency f_g of about 25 kHz and a slope

7

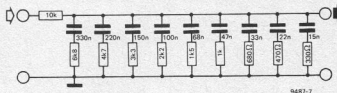

8

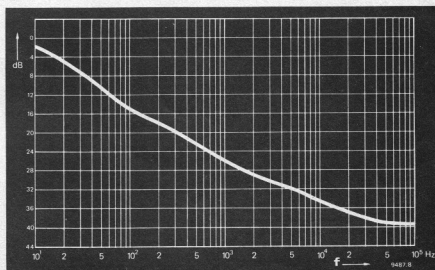

Table 2

length of shift register (n):	Exor feedback taken from outputs:	cycle time in clock periods T _k :
3	Q3 and Q2 (Q1)	7
4	Q4 and Q3 (Q1)	15
5	Q5 and Q3 (Q2)	31
6	Q6 and Q5 (Q1)	63
7	Q7 and Q6 (Q1) or Q4 (Q3)	127
8	x)	255
9	Q9 and Q5 (Q4)	511
10	Q10 and Q7 (Q3)	1023
11	Q11 and Q9 (Q2)	2047
12	x)	4095
13	x)	8191
14	x)	16,383
15	Q15 and Q14 (Q1) or Q4 (Q11) or Q7 (Q8)	32,767
16	x)	65,535
17	Q17 and Q14 (Q3)	131,071
18	Q18 and Q11 (Q7)	262,143
19	x)	524,287
20	Q20 and Q17 (Q3)	1,048,575
21	Q21 and Q2 (Q19)	2,097,151
22	Q22 and Q21 (Q1)	4,194,303
23	Q23 and Q5 (Q18) or Q9 (Q14)	8,388,607
25	Q25 and Q3 (Q22) or Q7 (Q18)	33,554,431
28	Q28 and Q3 (Q25) or Q9 (Q19) or Q13 (Q15)	268,435,455
31	Q31 and Q3 (Q28) or Q6 (Q25) or Q7 (Q24) or Q13 (Q18)	2,147,483,647
33	Q33 and Q13 (Q20)	8,589,934,591

x) This shift register length requires EXOR feedback from four outputs.

of 6 dB per octave. The output impedance is about 1k; the peak value of the white noise voltage at the output is about 4 V. It can be calculated that this peak value is about 3.16 times the r.m.s. value.

Consequently, this noise signal is eminently suitable for testing loudspeakers and amplifiers. If the drive level is set so that no 'clipping' occurs (this is audible as a change in the timbre of the noise), the amplifier will deliver only 10% of its maximum output power. This will usually mean that the loudspeaker is in no danger of falling victim to the measurements.

To conclude with, figure 7 gives a circuit for a 3 dB per octave low-pass filter. This can be connected to the output to convert the 'white' noise into 'pink'. It is strongly recommended to use 5% capacitors and resistors. Figure 8 shows the frequency response of this filter.

AUDIO WATTMETER

J.Jacobs

Tantalized by the scent of more watts, potential buyers are often seduced by the over-glowing specifications that some manufacturers give for their amplifiers. On closer investigation, for instance, a '2 x 30 watt' amplifier may only by quoting music power, with the real power at no more than 20 watts sine power per channel, and with both channels being driven simultaneously the maximum power turns out to be only 2 x 14 watts. By means of the wattmeter described in this article, it is possible to determine the real output power of an amplifier (up to 140 watts per channel into a resistive load).

The important figure in an amplifier's power specifications is the total output power with both channels driven. One channel on its own may deliver more power than with its partner if the power supply is inadequate. Also remember that it is unwise to test an amplifier beyond its specification, in case the heat sinks, for instance, are only sufficient for running within the specified limit.

The actual output power of an amplifier can only be determined accurately by using an audio tone generator (signal source), an oscilloscope (to inspect the waveform), and an audio wattmeter. The wattmeter described here has been designed to have a wide frequency range (5 Hz-400 kHz) and is suitable for use up to 140 watts (into either 4 or 8 ohms).

Various Measuring Methods

The output power can be measured in various ways, as shown in figures 1,2

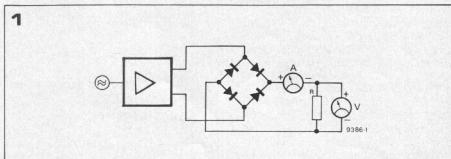

and 3. In the arrangement of figure 1, the output signal of the amplifier is rectified by a bridge rectifier and then fed to a load resistor (R) via an ammeter. A voltmeter is connected in parallel with the load resistor. The output power is calculated by multiplying together the current and voltage values given by the meters. The advantages of this method are its simplicity and wide frequency range; furthermore, it is only necessary to measure DC voltages and currents. However, the non-linearity of

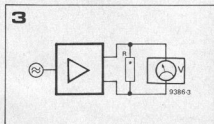
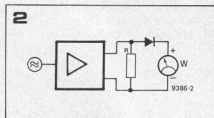

the rectifier and the meter often leads to inaccurate results.

Figure 2 shows a method where the output of the amplifier is connected directly to the load resistor R. This resistor is shunted by a rectifier and moving-coil instrument in series. The power can be read directly from the meter. The same comments that apply to figure 1 are also valid for this system, with the extra disadvantage that the indication is non-linear, so that a custom-calibrated scale is required.

Figure 3 shows a third possibility where an electronic AC voltmeter is connected in parallel with the load resistor R. This allows a high degree of accuracy because the non-linearity of the rectifier and the meter can now be compensated for by the electronics. The drawback with this system is that the output power is not presented as a direct reading: it must be calculated from the formula

$$P = \frac{V^2}{R}$$

It is possible, of course, to calibrate one or two scales corresponding to specific resistance values (4 and 8 Ω , for instance).

From the above, it can be concluded

Figures 1, 2 and 3. Various ways of accurately determining the output power of an amplifier.

Figure 4. Detailed circuit diagram of the wattmeter, two of these circuits being required for stereo equipment.

Figure 5. A simple symmetrical power supply suitable for use as the current source for the wattmeter.

that each method has its drawbacks. However, the method shown in figure 3 has fewer disadvantages than the others, so it was chosen for the wattmeter described here.

The circuit

The amplifier under test is loaded by several resistors connected in series/parallel (figure 4). Instead of using high power 4 and 8 Ω resistors, which would be difficult to obtain, these values are approximated by the resistor networks shown. If 17 W types are used, the total power dissipated can be anything up to 140 W. Don't mount these resistors too close to each other or to a base board: they can get very hot! It is recommended that non-inductive resistors are used here - normal carbon resistors will do quite well.

The load resistance is selected with S2, which should preferably be a make-before-break type. Note that the position marked '600 Ω ' only gives 600 Ω load impedance when S3 is in position 1. This facility has been included for dB measurements, where 0 dB corresponds to 0.775 V across 600 Ω (1 mW).

S3 is the range selector switch. With the resistance values shown, the ranges will be sufficiently accurate. The '9 k' resistor is actually two 18 k resistors connected in parallel. The opamp is connected in a standard AC voltmeter configuration. The trick is that the opamp tries to maintain the same voltage on both its inverting and non-inverting inputs. The non-inverting input is connected to the input, and the inverting input 'sees' the voltage across the series connection of R1, P1 and C1. The opamp will therefore produce an output current that builds up exactly the right voltage (i.e. the input voltage) across this series connection.

The meter is connected in a bridge rectifier circuit in series with the opamp output. The output current must flow through the meter, and any non-

linearities of the diodes (or meter) are compensated for by the opamp. The (rectified AC) current through the meter is equal to

$$I_M = \frac{V_{in}}{R_1 + P_1},$$

provided the impedance C1 is negligible when compared to $R_1 + P_1$, at the lowest frequencies involved. This capacitor should be a non-polarised type or, if this is unavailable, two 1000 μ capacitors connected 'back-to-back' as shown in the diagram. The 47 nF capacitor is necessary to maintain a low impedance at high frequencies. The pin numbering shown for the opamp refers to the TO or mini-DIL case style. The bandwidth is set by the compensation networks R2/C2 and C3. With the

The procedure is as follows.

1. Set S2 in the '600 Ω ' position.
2. Set S3 in position 2.
3. Temporarily short out C1.
4. Connect a 2k Ω resistor between the '+10 V' supply and the input.
5. Adjust P1 for full scale deflection (e.g. 3 Watts on the 4 Ω scale).
6. Remove the resistor and the short across C1.

It should be noted that the scale is not linear - it is square-law. As an example, if there are 10 divisions on the original (linear) scale on the meter, and full scale is now '300', the original markings will now correspond to '0', '3', '12', '27', '48', '75', '108', '147', '192', '243' and '300'.

Furthermore, when using the instru-

5

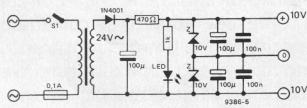

values shown it will be approximately 400 kHz.

Power Supply

The supply voltage used here for the opamp is approximately ± 10 V. The current consumption of the circuit (even in the stereo version) is so low that a very simple supply is sufficient. Figure 5 gives a simple, symmetrical supply which is suitable. The two 100 nF capacitors are for h.f. decoupling, and although they are shown in the power supply here, they should be located as close as possible to the opamp.

Calibration

The wattmeter is calibrated with P1.

ment one must realise that the scale calibration is only valid for a sine-wave input. If the sine-wave sounds audibly distorted, the actual power output can be either higher or lower than the value indicated.

In general, one should not consider this unit to be 'precision instrument'. This is one of the reasons why precision resistors are not specified. However, no-one should worry about the difference between, say, 100 W and 'only' 95 W - it just is not audible.

4

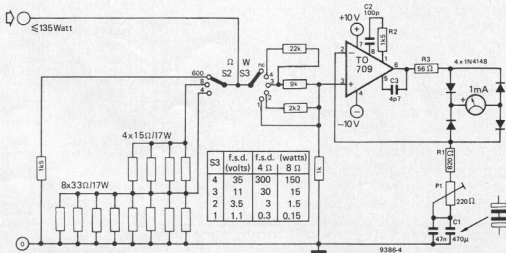

ELEKTROSCOPE

PART 2

A linear timebase and stable trigger circuits are essential to the operation of an oscilloscope. Good linearity of the timebase ensures that there is no distortion of the displayed waveform along the X-axis, while stable triggering ensures a jitter-free display.

In this month's article the circuits of the timebase, trigger circuit, X and Y amplifiers, channel switches and Y-preamps are discussed.

For the benefit of the less experienced reader the general principles of timebase and trigger circuits will briefly be discussed. The timebase output consists of a linear ramp or sawtooth voltage which is applied to the X plates of the oscilloscope, causing the trace to sweep horizontally across the screen in a linear fashion. Once the trace has been deflected across the entire screen width the ramp voltage drops rapidly to zero and the trace returns quickly to the starting position. To prevent the flyback or retrace from appearing on the screen the CRT beam current is cut off during this period, as mentioned earlier.

During the sweep the trace is deflected in a vertical direction by the signal applied to the Y plates, thus causing the input waveform to appear on the screen. If the timebase were allowed to free run with no trigger input then it is likely that the sweep would not start every time at the same point on the signal waveform. The portion of the signal waveform displayed during each sweep would thus be different, and the trace would appear to run one way or the other across the screen (figure 1A).

In order to obtain a stable trace the timebase must not be allowed to free run but must be started at the same point on the waveform for each sweep. This is shown in figure 1B. The trigger circuit detects the amplitude of the waveform and also whether the slope is positive or negative-going - it would not do to have one sweep of the timebase triggered on a positive slope and the next sweep (at the same level) on a negative slope, since this would give rise to a mixed trace on the screen.

Where successive cycles of a waveform are of the same amplitude the trigger level is relatively unimportant and it is common practice to trigger near the zero-crossing point so that the trigger point does not vary if the signal amplitude changes (figure 1C). However, if the amplitude of successive cycles was not the same then triggering at the zero-crossing point would mean that successive cycles of differing amplitude would appear at the same point on the screen. In this case the timebase must be triggered only on the highest amplitude cycle of the waveform (figure 1D). The trigger circuit is thus provided with a trigger level control to ensure reliable triggering on any repetitive waveform.

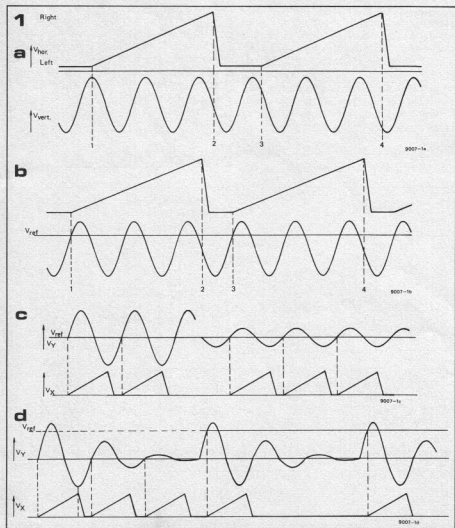

Figure 1. Showing the principle of a triggered timebase.

Figure 2. Block diagram of the Elektroscope timebase and trigger circuit.

Figure 3. Diagram of the trigger circuit.

Figure 4a. Circuit of the timebase.

Figure 2 shows a block diagram of the trigger circuit and timebase. The output of the Y1 or Y2 preamp or an external signal may be selected as the trigger source. The trigger signal is compared with a continuously variable reference voltage (trigger level control). When the signal level exceeds the trigger level the output of the comparator goes high, and when the signal level falls below the trigger level the comparator output goes low.

A polarity selector determines whether the timebase shall trigger on the positive or negative-going edge of the comparator output. The selected edge triggers a monostable that produces a short, fixed-length pulse which triggers the sweep generator. Finally, the output of the sweep generator is buffered by an output stage which drives the X amplifier. With the timebase in the 'automatic' mode the timebase will free run in the absence of a trigger signal. This is particularly useful when observing DC levels which provide no trigger signal.

Trigger circuit

The complete trigger circuit is given in figure 3. T1 provides a fairly high input impedance and a gain of 4.7 to the input signal. The output from the collector of T1 is fed into the inverting input of an LM311 high speed comparator, while the non-inverting input is fed from the slider of P1 to provide the trigger reference level. A small amount of positive feedback is applied around the comparator via R12 to provide a regenerative or 'Schmitt Trigger' type of action to avoid trigger jitter on noisy waveforms.

Triggering of the timebase is performed by the upper of the two monostables IC3. This can only be triggered by a positive-going pulse, so this makes for easy selection of trigger polarity. With S5 in the 'pos.' position the comparator output is routed through N4 and N3 so that the timebase is triggered on a positive-going edge. With S5 in the 'neg.' position the output of the comparator is inverted by N1 (giving a positive pulse on the negative-going edge of the comparator output). The output of N1 is routed through N2 and N3 to the B input of the monostable. When the monostable is triggered it provides a short negative-going pulse to trigger the timebase.

The second monostable is associated with the auto free-run facility. When a trigger signal is present this monostable is continuously retriggered and its Q output remains high. In the absence of a trigger signal the monostable will reset and the Q output will go low, thus continuously triggering the timebase when S4 is in the auto position. The trigger circuit may be inhibited and the timebase switched into a continuous free-run position, thus grounding the trigger input of the timebase.

Timebase

The timebase (figure 4a) makes use of the well-known 555 timer. Those un-

4b

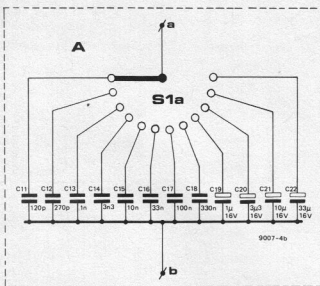

5

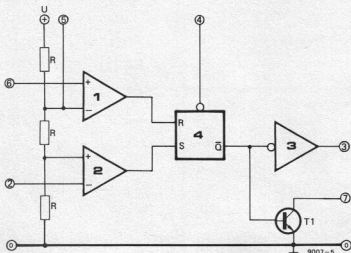

familiar with this IC should read the following description in conjunction with the internal diagram of the 555, given in figure 5.

Before a trigger pulse arrives to trigger the timebase the trigger input (emitter of T4) is held high by R30, so T4 is turned off and the collector voltage is at +15 V. The trigger pulse grounds the emitter of T4, turning it on so that the collector voltage, and hence the voltage at the top end of R29, falls. This takes the voltage on the inverting input of comparator 2 of the 555 below the voltage on the non-inverting input, so the output goes high, setting flip-flop 4 (figure 5). T1 (figure 5) is turned off, removing the short across the timing capacitor (block A in figure 4a), which is now charged linearly by the constant current source T2. When the voltage on the timing capacitor exceeds 2/3 supply voltage the output of comparator 1 (figure 5) goes high, resetting the flip-flop, which turns on T1 and shorts out the timing capacitor.

Figure 4b. Timebase range switch and timing capacitors.

Figure 5. Internal circuit of the 555 timer.

Figure 6. Circuit of the X and Y output amplifiers.

Figure 7. Printed circuit board and component layout for the X and Y output amplifiers.

6

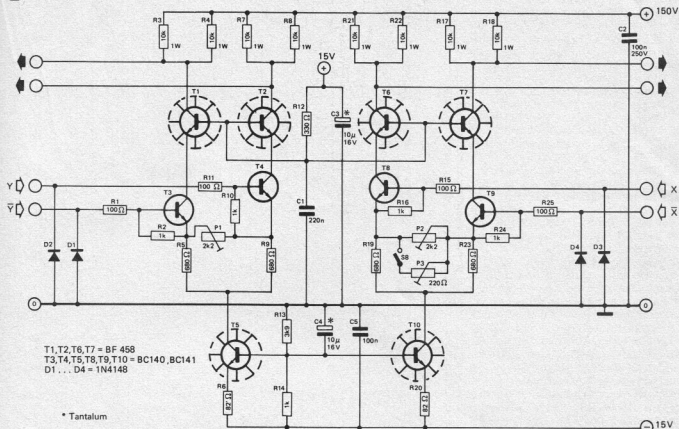

7

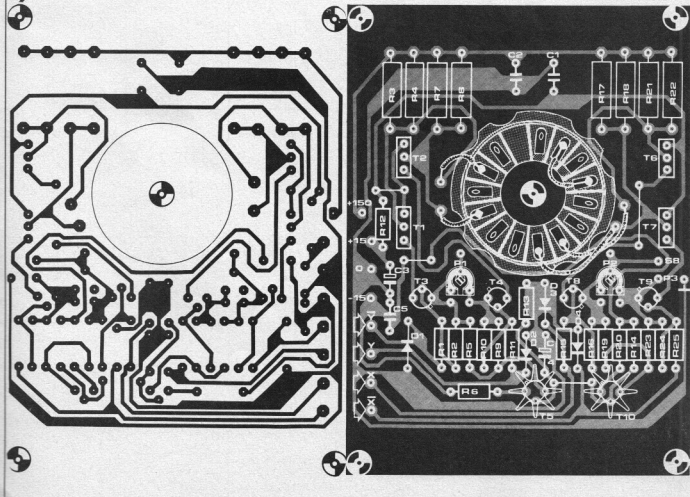

To avoid current being robbed from the capacitor, which would spoil the ramp linearity, the ramp output is buffered by a high impedance amplifier comprising T5 and T6. The sweep output is taken from the collector of T6. During the sweep the trigger input is inhibited by T3. This transistor is turned on when the ramp voltage exceeds its V_{be} and it shorts the base of T4 to ground for the duration of the sweep. This also facilitates the free-run facility. When the trigger circuit is in the free-run mode, or in the auto mode with no input signal, the emitter of T4 is permanently grounded. At the start of each sweep T4 will be turned on and will trigger the 555. It will then be turned off by T3 until the 555 resets, when T3 will turn off and T4 will turn on again, thus retriggering the timebase.

The flyback blanking pulse, which is obtained from pin 3 of the 555, is routed through the beam switching circuit where it is gated with the chop mode blanking pulses. Fine speed calibration of the timebase is provided by P2, which varies the current through T2, and X-position control is provided by P3, which applies a variable DC bias to one input of the X amplifier.

Timebase range selection is performed by S1a (figure 4b), which switches in various values of timing capacitor. This figure corresponds to block A in figure 4a. A second bank of this switch, S1b, is used to switch automatically from the 'chop' to 'alternate' channel switching mode. From 100 ms/cm to 1 ms/cm the 'chop' mode is used, and from 300 μ s/cm upwards the 'alternate' mode is used.

X and Y output amplifiers

It will be convenient at this point to describe the X and Y output amplifiers, since an understanding of their operation is necessary to understand the design philosophy behind the channel-switching circuits.

Each amplifier (figure 6) consists of a differential cascode amplifier, and the X and Y amplifiers are identical except for the x5 trace expand switch (S8) of the X amplifier.

As an example, the Y-amplifier proper consists of a differential amplifier (T3/T4) with a current source (T5) in the common emitter connection. This configuration, known as a 'long-tailed pair', can handle relatively large input voltage swings. The 'cascode' transistors T1 and T2 serve as output buffers. They are used in a grounded base configuration, at a base voltage of 15 V. This arrangement has two advantages: the differential amplifier proper operates at a reasonably low collector voltage, so high-gain transistors can be used, and there is very little internal feedback from output to input, so there are practically no stability problems.

The gains of the amplifiers may be adjusted by P1 and P2 and by P3 in the x5 position. Both amplifiers operate from the +150 V H.T. rail, and their outputs are connected direct to the X

8

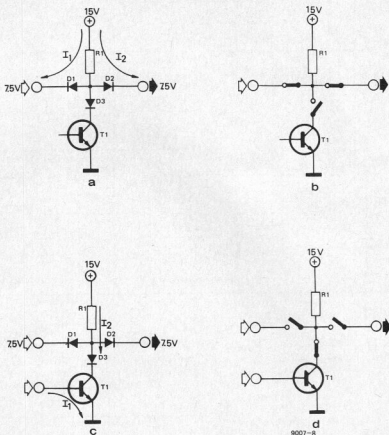

and Y plates.

To avoid problems due to loading of the outputs by long leads the X and Y amplifier p.c. board is mounted directly behind the CRT base. The layout of this board is given in figure 7.

Electronic switches

The signal switching arrangements in the Elektroscope are fairly complicated. Firstly, the (differential) outputs of the Y preamplifiers must be routed to the inputs of the Y output amplifier, either one at a time when only Y1 or Y2 is selected, or alternately at high speed in the Y1/Y2 chopped or alternate modes. Secondly, switching must be included to transpose the outputs of the Y2 preamplifier to invert the trace. Finally to switch between the normal and X-Y modes it must be possible to route either the timebase outputs, or the output of the Y1 preamplifier, to the inputs of the X amplifier.

To avoid problems that may be caused by long lengths of lead, such as capacitive loading, instability, hum pickup etc. the switches cannot be mounted on the front panel but must be located so that the signal path between the Y preamps and the output amplifiers is as short as possible. This means mounting the switches at the back of the Y preamp boards.

Commercial oscilloscopes overcome the problem of controlling such switches by ingenious mechanical linkages such as extension spindles, rods, Bowden cables

9

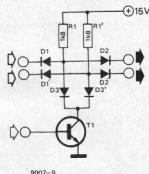

Figure 8. Showing the principle of the electronic switch.

Figure 9. The electronic switch may be extended to two or more channels, still controlled by a single transistor.

Figure 10. Circuit of one Y preamplifier.

Photo 1. The completed output amplifier board.

Table 1. Test point voltages for the Y preamp.

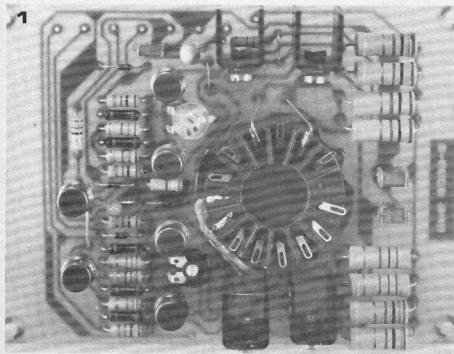

and the like, but such solutions are not suitable for the amateur, who generally likes the mechanical arrangements to be simple. In addition the Y1/Y2 channel switches must be completely electronic as they have to operate at the chopping frequency of 50 kHz. For these reasons it was decided to make all channel switching in the Elektroscope completely electronic. This has the ad-

ditional advantage that all these complicated functions can be controlled by single pole switches.

The principle of the electronic switch is shown in figure 8. When T1 is turned off D1 will always be forward biased provided the input voltage does not exceed the H.T. voltage (+15 V). The voltage at the junction of D1 and D2 will thus follow the input signal, but

Table 1.

Y preamp test point voltages

Test Point	Voltage	Conditions
A	+2.6 V	Input grounded.
B	+2 V	P1 in mid-position.
C	+9.5 V	
D	+10 V	
A	+2.6 V	Input grounded.
B	+2 V	P1 at end of travel
C	+9 ... +10 V	travel
D	+9.5 ... +10.5 V	

All voltages measured with a 20 k Ω /V meter. A tolerance of $\pm 10\%$ on these readings is allowable. Measurements at points A' - D' will be identical.

will always be about 0.6 V higher due to the forward voltage drop across D1. The output will follow the signal at the junction of D1 and D2, but will always be 0.6 V lower due to the forward voltage of D2, i.e. it will be equal to the input voltage.

Provided D1 and D2 have approximately the same characteristics, any distortion introduced due to variations

10

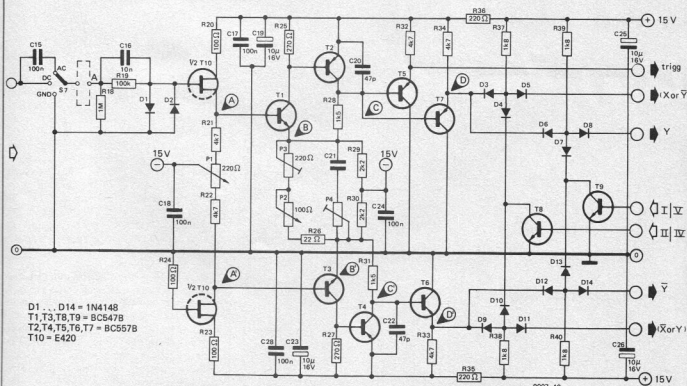

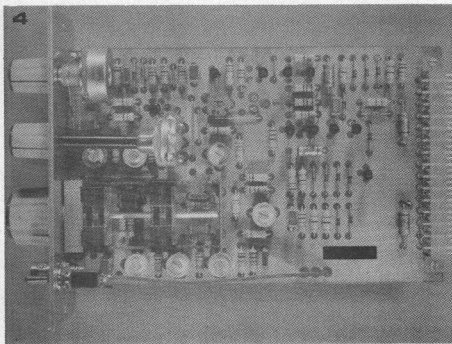
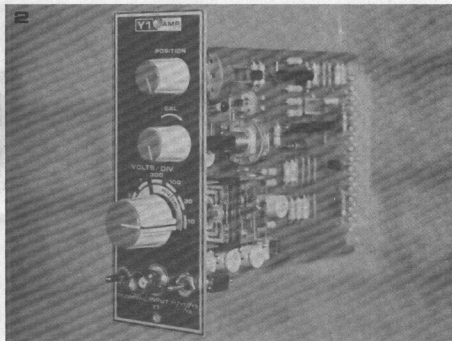

in the forward voltage of D1 with variations in the current through it will be cancelled by similar variations in the voltage drop of D2, provided the input and output impedances are similar.

When T1 is turned on by feeding current into its base the voltage at the junction of D1, D2 and D3 is held to just above the forward voltage drop of D3 (slightly greater due to the saturation voltage of T1) provided the input voltage remains above 0 V. Again about 0.6 V is dropped across D2, so the output voltage is approximately 0 V. When the output of the switch is connected in parallel with other switches then D2 will be cut off by any signals present on their outputs, provided the voltage is greater than 0 V. When the electronic switch is in the 'off' position therefore, it will not load the output of any other switch that is on.

If a switch is to control more than one signal channel then it is necessary to duplicate only the resistor/diode network, not the transistor, as shown in figure 9. D3 and D3' isolate the two channels from each other.

Y preamplifiers

The circuit of one Y preamplifier is given in figure 10. It will be seen that, with the exception of the trigger output taken from emitter follower T5, the circuit is completely symmetrical. This improves temperature stability and also provides the differential outputs necessary to drive the output amplifiers.

The input stage consists of a dual-FET T10 connected in a differential source-follower configuration. Use of a dual-FET means that the two devices are matched and are also in close thermal contact so that their characteristics will track together with temperature changes, thus minimising drift of the DC conditions within the amplifier. It is possible to use two E300 FET's mounted in a common cooling clip, but it may be necessary to experiment with the value of R21 to achieve a balanced condition at the outputs of the preamp.

The next two stages of the preamp are also differential, comprising transistor pairs T1/T3 and T2/T4. With the front panel gain control P2 in the 'cal' position the gain of the preamp may be varied between about 10 and 50 by P3. Provision has been made on the p.c. board layout for a compensation circuit P4/C21 to extend the h.f. response of the preamplifier. However, this is included only for the benefit of the serious experimenter and these components are not included in the parts list. P1 is the Y-position control.

To enable the preamplifier to drive the output amplifier and the inherent capacitances in the electronic switches without undue loss of bandwidth, emitter followers T6 and T7 are provided.

The electronic switches consist of T8, T9 and their associated diode networks D3 to D14. In the case of the Y1

2

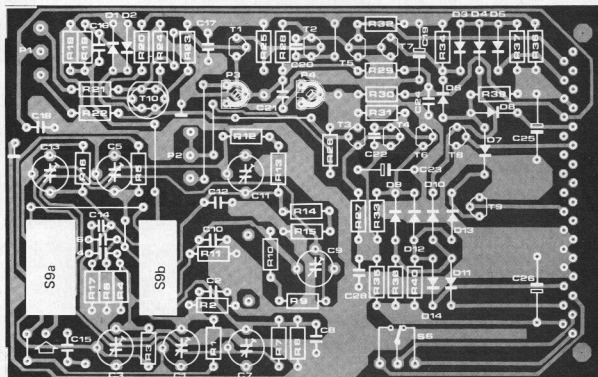
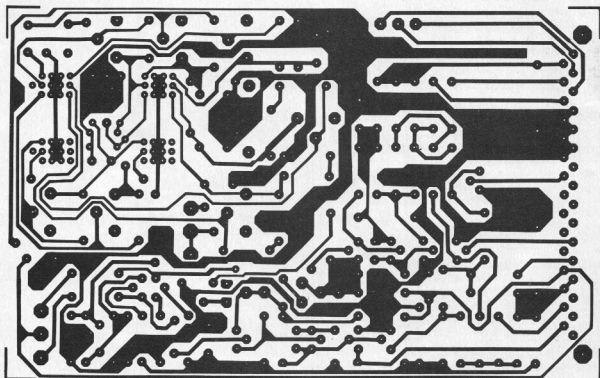

Figure 12. Printed circuit board and component layout for one Y preamp and attenuator.

Photo 2, 3 and 4. Three views of the completed Y preamp, showing the wiring to the two toggle switches.

preamp T9 controls the switching of the Y and \bar{Y} outputs to the inputs of the Y output amplifier, while T8 controls the switching of the outputs to the inputs of the X amplifier for the X-Y mode. In the case of the Y2 preamp T9 again controls switching to the Y output amplifier, but T8 switches the outputs of the Y preamp to the Y amplifier inputs in a transposed manner for the trace invert mode (i.e. Y output to \bar{Y} input and \bar{Y} output to Y input)

Y attenuator

When connected to the Y amplifier and correctly calibrated the Y preamplifier has a basic sensitivity of 10 mV/cm. To display larger input signals without exceeding the screen limits some form of attenuator must be incorporated. This is connected behind S7 in figure 10 and its circuit is given in figure 11. The input resistance of the Y preamp is 1 M, and the input attenuator consists basically of resistive potential dividers designed to maintain a constant input resistance of 1 M while giving input sensitivities of 30 mV, 100 mV and so on.

However, the 1 M input resistance is also shunted by a capacitance of a few pF due to the gate capacitance of the FET, and if this were left uncompensated it would form a low-pass filter with the series arm of the attenuator, leading to an early roll-off in the frequency response. To avoid this the attenuator resistors are paralleled by capacitors. When the trimmer capacitors are correctly adjusted the reactances of the capacitors (taking into account the preamp input capacitance) will be in the same ratios as the attenuator resistors, so the attenuation factor will remain constant whatever the frequency. However the input impedance will reduce with increasing frequency due to the falling reactance of the capacitors.

It will be noted that the lower resistors in the attenuator sections are shunted with in some cases fairly large values of capacitance, and at first sight this may seem strange: it is the undesirable effects of the FET shunt capacitance for which we are trying to compensate, so why make it deliberately worse? The reasons for this are twofold. Firstly, this arrangement gives a fairly constant input capacitance of around 30 pF. This is necessary if the oscilloscope is to be used with high impedance probes, since these are designed to work into an input resistance of 1 M in parallel with between 20 and 40 pF. Secondly, the use of shunt capacitors avoids the necessity for impossibly small trimmer capacitors. For example if R2 were shunted simply by the 5 pF or so of the FET then R1 would have to be shunted by a trimmer whose reactance was $\frac{1000,000}{330}$ times as much, or to put it

another way, whose capacitance was .0003 times the FET capacitance — about .0015 pF, which is ridiculous.

The Y attenuators are mounted on the same p.c. board as the preamplifiers, the

11

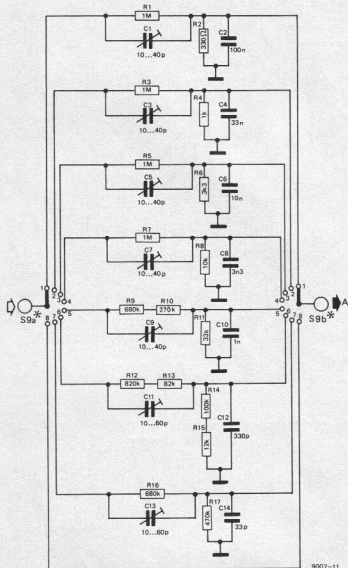

9007-11

Figure 11. The compensated Y input attenuator.

layout of which is given in figure 12. For screening and stability an earth plane is provided on the upper side of this p.c. board, and care should be taken not to let the bodies of components short to this ground plane. This applies particularly to unsleeved electrolytic capacitors, to capacitors with metal end caps (e.g. Siemens MKM types) and to resistors, which may have only a thin paint film covering the end caps. The best plan is to place a thin strip of card beneath each component while soldering to stand it off from the board, or alternatively to give the top of the board a good coating of lacquer or insulating varnish.

NOTE All component lists will be given in the final part of this article.

QUADI-COMPLIMENTARY COMPLEMENTED

Several readers have sent us comments and queries concerning the article Quadi-Complimentary (Elektor, December 1975). Some further explanation appears to be in order.

The original article dealt with the principles involved in Quad's 'Current Dumping Amplifier' type 405. The majority of the readers request us to investigate the possibility of using this principle in a new amplifier design.

Before going into details, it should be plainly stated that this will be practically impossible if the final design is to be a reliable 'home construction' project in the Equa, Edwin, Equin tradition. This is why we are still looking for alternatives; see 'Ejektör' in last month's issue.

The 'current dumping' principle is unsuitable for a home construction project; it should only be considered in mass-produced commercial amplifier designs.

Why? This can be made clear as follows. In the case of 'current dumping' it is of prime importance that four impedances Z_1 , Z_2 , Z_3 and Z_4 should be very accurately defined. And that is the main difficulty! Figure 1 shows the

overall block diagram; the conditions for $Z_1 \dots Z_4$ are given in figure 2.

The impedances Z_1 and Z_3 of figure 1 are shown as resistors R_1 and R_3 in figure 2. For various reasons, Z_4 becomes a self inductance L_4 . Unfortunately, in practice this will be a coil rather than a pure self inductance, so there will be a resistance R_4 in series with the coil.

This, in turn, means that Z_2 must consist of a capacitor C_2 and a resistor R_2 connected in parallel, in order to achieve the required bridge balance.

The bridge is in balance if:

$$Z_1 \cdot Z_3 = Z_2 \cdot Z_4 \quad *)$$

The transformation from figure 1 to figure 2 is defined by:

$$Z_1 = R_1$$

$$Z_3 = R_3$$

$$Z_2 = \frac{R_2}{1 + j\omega R_2 C_2}$$

$$Z_4 = R_4 + j\omega L_4$$

In this case there are two conditions for bridge balance:

$$R_1 R_3 = R_2 R_4, \text{ and}$$

$$L_4 = R_1 R_3 C_2 = R_2 R_4 C_2, \text{ or}$$

$$R_2 = \frac{L_4}{R_4 C_2}$$

In the theoretical case where R_4 is zero, R_2 becomes infinitely large and can be omitted.

In actual practice, however, two alignments are needed, both equally difficult. In an experimental circuit it proved necessary to use a preset potentiometer for R_2 and a trimmer for C_2 . The slightest deviation from bridge balance resulted in ugly cross-over phenomena.

A simple quiescent current adjustment as used in the Equin, for example, is a lot easier and gives better guaranteed results.

For a mass-produced version, the situation is somewhat different. There the specifications of the passive components $Z_1 \dots Z_4$ are a dead fix, so it is possible to eliminate the alignment procedure and still get (very) good results. ■

Literature:

Quadi Complimentary, Elektor 12, December 1975, p. 1220.

* Several readers have remarked that the assumption of an infinitely large open-loop gain also implies an infinitely large feedback factor. At first sight it would appear that this is what eliminates the non-linearity of the output stage. However, this assumption is incorrect. The balance condition for a finite gain A_0 is:

$$Z_2 Z_4 = Z_1 Z_3 + \frac{(Z_1 + Z_2) Z_3}{A_0}$$

This is where 'current dumping' differs fundamentally from the Edwin principle: in the latter case the highest possible A_0 , c.q. feedback factor, is indeed required.

1

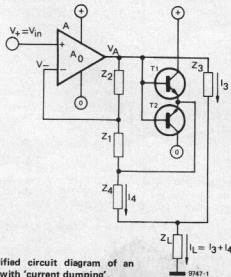

Figure 1. Simplified circuit diagram of an output amplifier with 'current dumping'.

2

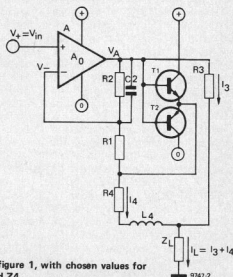

Figure 2. As figure 1, with chosen values for Z_1 , Z_2 , Z_3 and Z_4 .

BI-FET OPAMPS

Interesting results can often be obtained by using several different types of active device in one circuit. Examples of this type of 'hybrid' circuit are designs incorporating both transistors and valves (or 'tubes' Am. or 'bottles' Sl.) or TTL and CMOS, or bipolar transistors and FETs. A relatively new example of this is the BI-FET opamp. It consists of JFETs and bipolar transistors on the same chip, and this could well give interesting results at a reasonable price.

The manufacturer describes the new opamps as 'monolithic JFET-input operational amplifiers incorporating standard bipolar transistors on the same chip, manufactured using ion-implantation techniques'. Furthermore, 'these amplifiers feature low input bias and offset currents, low offset voltage and offset voltage drift, offset adjust which does not degrade drift or common-mode rejection, high slew rate, wide bandwidth, extremely fast settling time, low voltage and current noise and a low $1/f$ noise corner'. Since they are also supposed to be rugged and relatively cheap, it would appear that some further investigation is called for... The simplified circuit diagram of the new opamps (National Semiconductor types LF355, LF356 and LF357) is shown in figure 1. The ion-implantation manufacturing technology makes for well-matched FETs in the input stage, so that the input offset voltage can be very small. The input impedance is $10^{12} \Omega$ and the input bias current is only 30 pA. As the technical specifications show (table 1) the input noise figures are also exceptionally low. The second stage is a 'long-tailed pair' of bipolar transistors. This stage provides most of the open-loop gain (106 dB, or 200,000 x).

The output stage is a rather unusual hybrid quasi-complementary circuit. The basic circuit is shown separately in figure 2. It is short-circuit protected and it can withstand capacitive loads up to 10 nF without danger of instability. These BI-FET opamps are eminently suitable for use in precision high-speed integrators; fast D/A and A/D converters; high impedance buffers; wide-band, low-noise, low-drift amplifiers; logarithmic amplifiers; sample and hold circuits; etc. They can also be used, of course, in conventional opamp circuits. One of the few conventional things about these opamps is the pinning: they are pin-compatible with the well-known 741, as shown in figure 3. The only thing to watch is that the offset control is connected to the positive supply - not the negative supply as with the 741.

Applications.

A basic wide-band amplifier circuit using the LF357 is shown in figure 4. If required, an offset control can be included as shown in figure 3. The gain is $\times 10$, the p-p output voltage swing is 20 V, the power bandwidth is 500 kHz and the distortion is less than 1%. A more sophisticated circuit, using the LF356, is shown in figure 5. The

parasitic input capacitance C_1 consists of the input capacitance of the opamp (3pF or less) and any additional capacitance introduced by the printed circuit board of other wiring. It can be compensated for by including C_2 , where

$$C_2 \geq \frac{R_1 \cdot C_1}{R_2}$$

In this case the power bandwidth is approximately 240 kHz at the same distortion level (1%).

A more interesting application is shown in figure 6. This is a sharp notch filter; provided the components in the twin-T network are sufficiently well matched a quality factor Q of more than 100 can be obtained. As an example, if

$$R = 2R_1 = 10M \text{ and } C = \frac{C_1}{2} = 300 \text{ p}$$

the centre frequency of the notch will be approximately 100 Hz and the 'depth' will be -55 dB.

Final notes

The National Semiconductor opamps described here are the first of a new generation. NS have already announced a FET-input 741, the LF13741. This has an input bias current of 200 pA, but in all other aspects (bandwidth, gain and rise-time) it has the same specifications as the 741.

Quite recently they introduced the LF352 series; these are instrumentation amplifiers with high gain linearity for low-level input signals and a high common-mode rejection ratio. They have also announced that the LF355, 356 and 357 are now to be made available in a much cheaper 8-pin mini-DIP version.

Furthermore, the opamps described here are already being supplied by Fairchild and Texas Instruments as second sources. This is often considered the 'acid test' of a new technology: how long does it take for other manufacturers to jump on the bandwagon....

(National Semiconductor application note).

Figure 1. Simplified circuit diagram of the BI-FET opamps.

Figure 2. Basic circuit of the output stage.

Figure 3. Pinning of the LF355, LF356 and LF357. They are pin-compatible with the 'traditional' 741, but the offset compensation is connected to the positive supply.

Figure 4. A basic wide-band amplifier circuit.

Figure 5. A more sophisticated circuit, including compensation for parasitic capacitances.

Figure 6. Circuit for a high-Q notch filter.

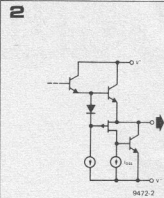
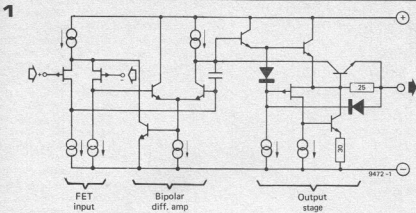

Table 1.

Absolute maximum ratings

Supply voltage	± 18 V
Power dissipation	500 mW
Operating temperature range	0°C. 70°C
T _j (max)	100°C
Differential input voltage	± 30 V
Input voltage range	± 16 V
Output short-circuit duration	continuous

DC electrical characteristics		LF355/6/7			UNITS
SYMBOL	PARAMETER	CONDITIONS	MIN	TYP	MAX
V _{os}	Input Offset Voltage	R ₂ = 50Ω, T _A = 25°C Over Temperature R ₂ = 50Ω		3 5	10 13
ΔV _{os} /ΔT	Average TC of Input Offset Voltage			0.5	
ΔTC/ΔV _{os}	Change in Average TC with V _{os} Adjust	R ₂ = 50Ω			μV/°C per mV
I _{os}	Input Offset Current	T _J = 25°C T _J < T _{HIGH}		3	50
I _B	Input Bias Current	T _J = 25°C T _J < T _{HIGH}		30	200
R _{in}	Input Resistance	T _J = 25°C		10 ¹⁰	200
A _{vol}	Large Signal Voltage Gain	V _i = ±15V, T _A = 25°C V _o = ±10V, R _L = 2k Over Temperature V _i = ±15V, R _L = 10k	25	15	12
V _o	Output Voltage Swing		±12	±13	
V _{cm}	Input Common-Mode Voltage Range	V _i = ±15V	±10	-12	
CMRR	Common-Mode Rejection Ratio		80	100	
PSRR	Supply Voltage Rejection Ratio		80	100	

PARAMETER	LF355		LF356		LF357		UNITS
	TYP	MAX	TYP	MAX	TYP	MAX	
Supply Current	2, 2	4	5	10	5	10	mA

AC electrical characteristics		LF355			LF356	LF357	UNITS
SYMBOL	PARAMETER	CONDITIONS	TYP	TYP	TYP	TYP	
SR	Slew Rate	LF355/6: A _v = 1, LF357: A _v = 5	5	12	50		
GBW	Gain-Bandwidth Product		2.5	5	20		
t _s	Settling Time to 0.01%		4	1.5	1.5		
e _n	Equivalent Input Noise Voltage	R _G = 100 Ω f = 100 Hz	25	15	15	nV/√Hz	
i _n	Equivalent Input Current Noise	f = 1000 Hz	20	12	12	nV/√Hz	
C _{in}	Input Capacitance	f = 100 Hz	0.01	0.01	0.01	pA/√Hz	
		f = 100 Hz	0.01	0.01	0.01	pA/√Hz	
			3	3	3	pF	

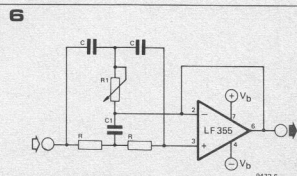
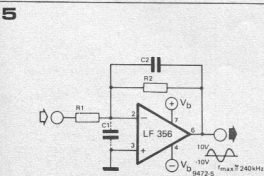
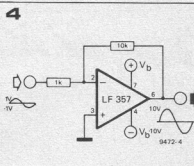
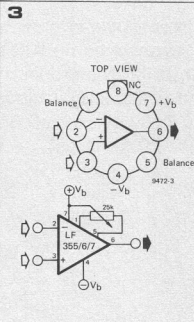

IC AUDIO

In this article two completely different types of high-power audio IC's are discussed. To avoid confusion the article is split into two parts. The first part deals with hybrid power-integrated circuits while the second section deals with the TDA 2020 IC.

1

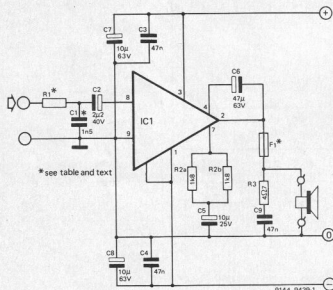

2

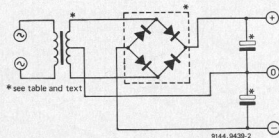

In a monolithic audio IC the entire circuit is integrated onto a single chip or die. As this chip is extremely small the problems involved in conducting away the heat dissipated in the circuit are enormous. Higher power audio IC's (greater than 20 W) generally use a hybrid form of construction whereby the output devices are on separate chips from the rest of the circuit, which may be integrated using monolithic or thick film techniques. The individual parts of the circuit are bonded to a large metal substrate and, after interconnections have been made, the whole assembly is encapsulated in resin or silicone rubber. The metal substrate provides good thermal contact with a heatsink, though the package is, of course, somewhat more bulky than a 14 pin DIL IC!

There are many hybrid audio IC's currently available, with power outputs up to more than 100 W, but of particular interest are a family of IC's manufactured by ITT, Skiltronics and Sanyo. These are of special interest

- because they are available with output powers from 20 to 40 W in an identical package, so the same circuit layout can be used for all versions.
- because they are obtainable from three different manufacturers, so they should be easier to obtain.

The maximum ratings and principal electrical characteristics of this family are given in table 1. Note that the Skiltronics type numbers are prefixed SPH, while the ITT and Sanyo type numbers are prefixed STK.

Figure 1 shows the external components required by the amplifier. The number of external components may seem rather large, but of course many of these are electrolytic capacitors, which are difficult to incorporate into a small package, and which might be damaged by the high temperatures that can occur within the IC. It will be noted that these circuits operate from a symmetrical supply (figure 2) with the loudspeaker direct coupled to the output.

Since the IC's are used as function building blocks or 'black boxes' the internal circuitry will not be discussed in detail. However, it should be stated that the output stage is of the quasi-complementary type, and the input stage is a differential amplifier of a fairly common configuration.

Precautions

Provided a few simple precautions are observed few problems should be encountered when using these IC's.

These are as follows:

- Both the positive and negative supply voltages must be applied to the IC simultaneously, since if only one voltage is applied a large d.c. offset will appear at the output, causing a large current to flow through the loudspeaker that could damage both loudspeaker and IC. Even a fuse in series with the loudspeaker will not protect the IC in these circumstances.

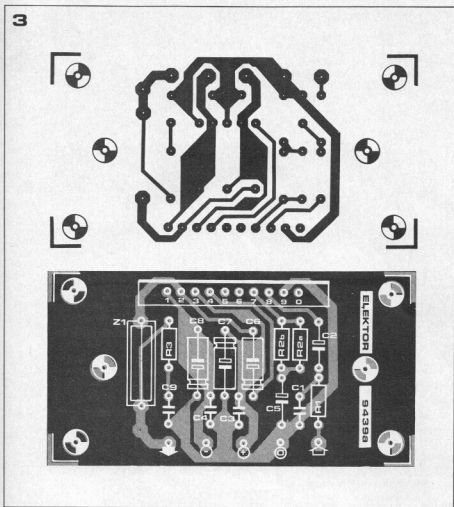

Figure 1. Application circuit for the 022, 025 032 and 036 IC's.

Figure 2. The Hybrid IC amplifiers require only a simple power supply.

Figure 3. Printed circuit board and component layout for the 022, 025, 032 and 036 IC's (EPS 9439a).

To minimise the d.c. current that flows through the loudspeaker (and hence the 'thump') when switching the amplifier on and off it is essential that the risetimes of both supply rails should be similar. Since the supply need only be a transformer, bridge rectifier and two reservoir capacitors this simply means that the reservoir capacitors should be of the same value. This will also ensure that the two supply voltages are as nearly the same as possible, which will minimise the d.c. offset voltage of the amplifier. This will normally be no more than ± 50 mV.

2. The second precaution is to ensure that the heatsink is of an adequate size, since these IC's do not incorporate thermal protection. The thermal resistance of suitable heatsinks is given in table 1. These are adequate even if the amplifier is driven for long periods at full output. For normal domestic use smaller heatsinks may be adequate.

When mounting the IC on a heatsink it is essential that the spacing of the fixing holes should be as accurate as possible, otherwise the heatsink or baseplate of the IC may become distorted, leading to poor thermal contact. Some silicone heatsink grease could be used to improve thermal contact.

3. It might be thought that fusing the positive and negative supply rails would be a suitable method of protection, but this is not the case since failure of a fuse in one rail would cause the fault condition discussed earlier, i.e. a large d.c.

Parts list for figures 1 and 3.

Resistors:

R1 = see text
R2a/R2b = 1 k Ω
R3 = 4 Ω 7

Capacitors:

C1 = see text
C2 = 2 μ 2/40 V
C3, C4, C9 = 47 n
C5 = 10 μ 25 V
C6 = 47 μ 63 V
C7, C8 = 10 μ 63 V

Semiconductors:

IC1 = types 022, 025, 032 or 036

Miscellaneous:

F1 = see table 1

offset on the output. The only fuse should be in the primary of the mains transformer, and this is intended to protect the power supply rather than the amplifier.

Construction

A printed circuit board and component layout suitable for use with IC's type 025, 032 and 036 is given in figure 3. The input resistor R1 forms an attenuator with the input impedance of the IC and should be chosen to provide the required input sensitivity/input impedance, taking into account the gain of the IC.

For example, suppose the STK032 is required to provide 25 W into an 8 Ω load with an input sensitivity of 1 V.

25 W into 8 Ω means an rms output voltage of approximately 14 V. The gain of the IC is about 30 dB or 31 times, so the voltage required at the input is 14/31 or 0.45 V. Since the required input sensitivity is 1 V this means that 0.55 V must be dropped across R1 so

R1 is $\frac{0.55}{0.45} \times Z_{in}$ or about 33 k. The input impedance of the amplifier (with R1) is thus 60 k.

R1 and C1 together form a lowpass filter to protect the IC against high slewrates (which gives rise to transient intermodulation distortion) by limiting the risetime of the input signal.

If R1 is changed then C1 should also be changed to maintain the same break-

4

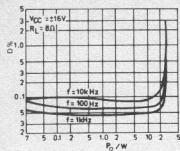

9144, 9439-4a

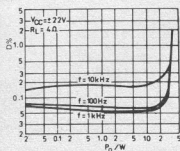

9144, 9439-4b

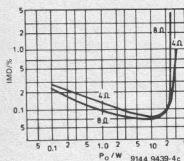

9144, 9439-4c

Figure 4. Distortion v power graphs for the 025.

Figure 5. Circuit for a 20 W amplifier using a single supply rail.

Table 1. Pertinent data for the 022, 025, 032 and 036 IC's.

Table 2. Absolute maximum ratings of the TDA2020.

Table 3. Electrical characteristics of the TDA2020.

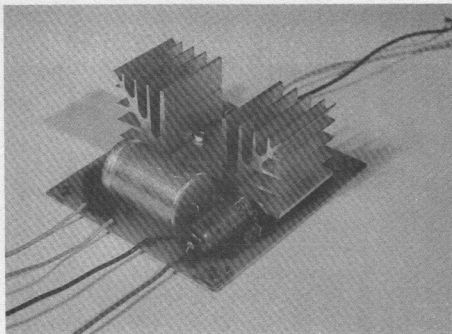

Table 1. Maximum ratings, electrical characteristics and applications data of hybrid audio IC's for use with symmetrical power supply

Skiltronics, ITT, Sanyo	SPH 022 — STK 022	SPH 025 STK 025 STK 025G	SPH 032 — STK 032	SPH 036 STK 036 STK 036
Maximum supply voltages	±25 V	±29 V	±32 V	±35 V
Nominal supply voltages	±19 V	±22 V	±24 V	±27 V
quiescent current	30-50 mA			
Minimum output power into	4 ohm 8 ohm	23 W 15 W	30 W 20 W	35 W 25 W
Maximum case temperature	85°C			
Maximum output short-circuit duration	two seconds under full drive			
recommended mains transformer	2 x 15 V 75 VA	2 x 17 V 90 VA	2 x 18 V 100 VA	2 x 20 V 120 VA
speaker fuse, if required	5...6 A, fast blow			
voltage gain (dB)	33 dB	30.5 dB	30.5 dB	30 dB
input impedance	27 k			
recommended thermal resistance of heatsink	2°C/W	1.7°C/W	1.5°C/W	1.4°C/W
bridge rectifier	40 V 2 A	40V/3.2A		80 V 5 A
Reservoir capacitor	>2200 μ	>3300 μ	>3300 μ	>3300 μ

Table 2

Absolute maximum ratings TDA2020.

V_s	Supply voltage	±22 V
V_i	Input voltage	V_s
V_j	Differential input voltage	±15 V
I_o	Output peak current (internally limited)	3.5 A
P_{tot}	Power dissipation at $T_{case} < 75^\circ\text{C}$	25 W
T_{stg}, T_j	Storage and junction temperature	-40 to 150°C

Table 3

Electrical characteristics TDA2020 ($V_S = \pm 17V$,
 $T_{amb} = 25^\circ C$ unless otherwise specified)

Parameter	Test conditions	Min.	Typ.	Max.	Unit	
V_S	Supply voltage	± 5		± 22	V	
I_d	Quiescent drain current		60		mA	
I_b	Bias current		0.15		μA	
$V_{i(off)}$	Input offset voltage		5		mV	
$I_{i(off)}$	Input offset current		0.05		μA	
$V_{o(off)}$	Output offset voltage		10	100	mV	
P_O	Output power	$d = 1\%$ $G_V = 30$ dB $T_{case} < 70^\circ C$ $f = 40$ to $15,000$ Hz $V_S = \pm 17V$ $R_L = 4 \Omega$ $V_S = \pm 18V$ $R_L = 4 \Omega$ $V_S = \pm 18V$ $R_L = 8 \Omega$	15	18.5		W
		$d = 10\%$ $G_V = 30$ dB $T_{case} < 70^\circ C$ $f = 1$ kHz $V_S = \pm 17V$ $R_L = 4 \Omega$ $V_S = \pm 18V$ $R_L = 8 \Omega$		24	20	
V_i	Input sensitivity	$G_V = 30$ dB $f = 1$ kHz $P_O = 15W$ $V_S = \pm 17V$ $R_L = 4 \Omega$ $V_S = \pm 18V$ $R_L = 8 \Omega$	260	380		mV
						mV
B	Frequency response (-3 dB)	$R_L = 4 \Omega$ $C_4 = 68$ pF	10 to 160,000		Hz	
d	Distortion	$P_O = 150$ mW to $15W$ $R_L = 4 \Omega$ $G_V = 30$ dB $T_{case} < 70^\circ C$ $f = 1$ kHz $f = 40$ to $15,000$ Hz	0.2	0.3	1	%
		$P_O = 150$ mW to $15W$ $V_S = \pm 18V$ $R_L = 8 \Omega$ $G_V = 30$ dB $T_{case} < 70^\circ C$ $f = 1$ kHz $f = 40$ to $15,000$ Hz	0.1	0.25		

point for the filter. As a rule-of-thumb, if R_1 is 1 k then C_1 should be 3n3, and if R_1 is increased then C_1 should be decreased by the same factor. For instance, if R_1 is increased to 10 k (multiplied by 10) then C_1 should be divided by 10 (reduced to 330 p). When making these calculations the output impedance of the source feeding the amplifier (e.g. a preamp) must be taken into account. For example, if the preamp has an output impedance of 5 k and R_1 is 1 k then the effective value of R_1 is 6 k, so the nominal value for C_1 should be divided by 6.

In practice, of course, the value of C_1 is not so critical. The value shown in figure 1 (1n5) can be used for any value of R_1 between 1 k and 5k6, for instance. Furthermore, the minimum value is 330 p.

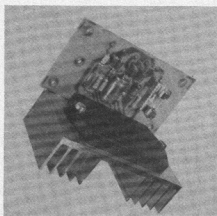

Distortion

Finally, figure 4 includes graphs of one important parameter not shown in table 1 - distortion. Figures 4a and 4b show harmonic distortion versus power output at three frequencies, into 8 Ω and 4 Ω loads, for the 025 IC, while figure 4c shows intermodulation distortion versus output power into 8 and 4 Ω loads.

5

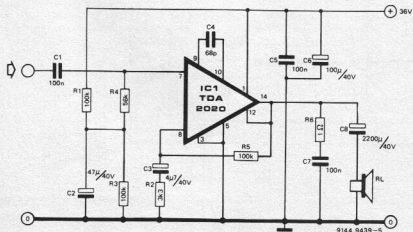

Twenty twenty

The next type of audio IC to be discussed is the SGS TDA2020. It is a monolithic audio IC that can achieve an output power of (typically) twenty watts continuous. Furthermore, crossover and harmonic distortion are low so that the IC is truly 'hi-fi'. The chip incorporates safe area limiting to keep the output transistor dissipation within acceptable limits, together with a

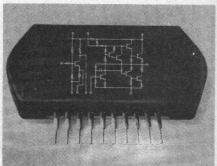

7

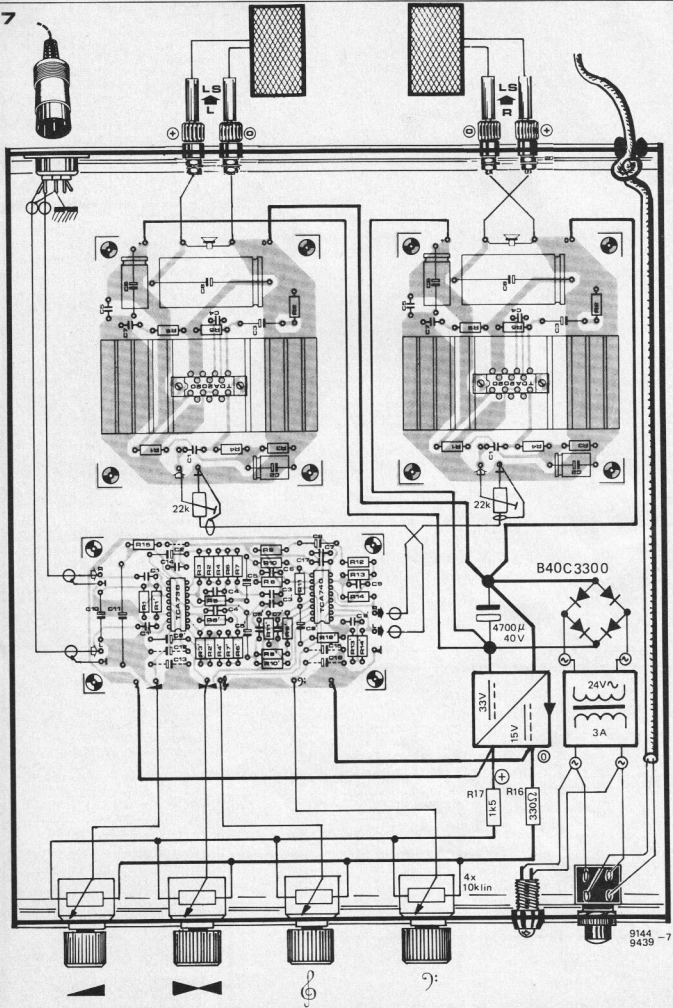

6

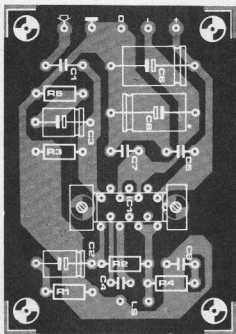
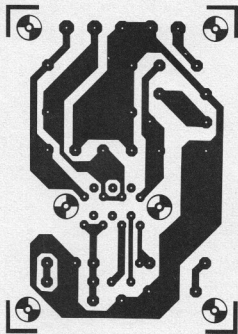

Parts list for figures 5 and 6.

Resistors:

R1, R3, R5 = 100 Ω
 R2 = 3k3
 R4 = 56 k
 R6 = 1 Ω

Capacitors:

C1, C5, C7 = 100 n
 C2 = 47 μ /40 V
 C3 = 4 μ /40 V
 C4 = 68 p
 C6 = 100 μ /40 V
 C8 = 2200 μ /40 V

Semiconductors:

IC1 = TDA2020

Figure 6. Printed circuit board and component layout for a 20 W amplifier using the TDA2020 (EPS 9144).

Figure 7. A suggested layout for an 'all IC' stereo amplifier using the TDA2020 and the TCA 730/740 control amplifier.

thermal shutdown system to protect the whole IC against overheating.

The absolute maximum ratings of the TDA2020, which should never be exceeded, are given in table 2. The electrical characteristics are given in table 3.

The TDA2020 may be used with either a symmetrical (\pm) power supply, in which case the loudspeaker can be direct-coupled to the output stage, or with a single power supply rail, in which case an output coupling capacitor is needed.

Although a direct-coupled output theoretically saves components, it has the disadvantage that the loudspeaker is unprotected against d.c. fault conditions in the amplifier, and the supposed saving is more than outweighed by the need to provide loudspeaker protection circuits. For this reason the practical circuit is based on an amplifier with a single power rail, as shown in figure 5.

In this circuit, 100% d.c. feedback is provided via R5, and the non-inverting input is biased to half the supply voltage by R1 and R3. This means that the quiescent output voltage of the amplifier is also half the supply voltage. The gain of this circuit is about 30 dB.

Maximum output power of 16 W into 8 Ω is thus achieved with an input voltage of 360 mV rms, or with a 4 Ω load 20 W may be obtained with a 285 mV input.

With an 8 Ω load, distortion at 1 kHz is less than 0.1% for output powers from 150 mW to 15 W. Distortion into a 4 Ω load is approximately twice this.

Figure 6 shows a printed circuit board and component layout for this particular application circuit. A special spacer (supplied with the TDA2020) is

mounted beneath the device before soldering it into the board. This supports the heatsink, which is mounted on top of the IC and is secured by bolts passed through the spacer. Good thermal contact between the IC and the heatsink is ensured by a copper slug which is integral with the IC package. Some heatsink compound should be smeared on the IC and the back of the heatsink to improve this contact still further.

The exact shape of the heatsink is unimportant, provided it fits the board. However, if the IC is to be run at full power for long periods of time then the thermal resistance of the heatsink should not be less than 2°C per watt. In normal domestic use heatsinks of up to 8°C per watt may be acceptable.

It should be noted that the copper slug (and hence the heatsink) is internally connected to pin 5, so the heatsink is at ground potential. However, if a symmetrical supply is used, the negative supply potential is present on the heatsink!

Figure 7 shows a suggested layout for a simple 'all IC' stereo amplifier using two TDA2020's and the TCA730/740 control amplifier described in Elektor 8. If a disc input were required then the control amplifier could be preceded by the IC disc preamplifier featured in Elektor 3.

The power supply to the TDA2020's may be unstabilized and is derived simply from a transformer, bridge rectifier and reservoir capacitor. The 15 V stabilized supply to the control amplifier may be obtained either from a suitable IC voltage regulator, or from a simple zener stabilizer. If the IC disc preamp is also used this, of course, has a built-in voltage regulator.

THE BF494

A CASE IN POINT

Editor's lament:

Oh why, tell me, why
Can our readership's eye
More clearly descry
Than an author, or I,
Any slip, imperfection,
Or faulty connection?

The BF 494 is an extremely useful HF transistor, and it is used in many Elektor circuits for this reason. The specifications are quite good and the price is quite reasonable, which means that it can be used as a kind of 'Universal HF Transistor'. Applications range from

found that these two reliable sources had different ideas about the BF 494 . . . A few 'phone calls to the two parties concerned taught us that, in this case, the Philips data are accurate. Pro-Electron, for once, appears to have slipped up. Figure 2 therefore gives the official pinning for the BF 494. As a final note we would like to remark that we were highly impressed by the rapid and energetic action undertaken by the 'Association Internationale Pro-Electron' to locate and remedy the mistake. We will continue to rely on their data handbooks in the future, albeit perhaps not quite so blindly . . .

Figure 1. The BF 494 according to Pro-Electron.

Figure 2. The BF 494 according to Philips. Note the interchanged collector and emitter connections.

116

(TO-92)

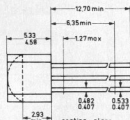
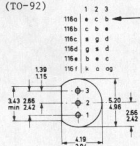

9784 1

1

Low power HF transistors

Transistors HF - HF-Transistoren



TYPE	RATINGS (at Tamb = 25°C, unless otherwise stated)							CHARACTERISTICS (at Tamb = 25°C, unless otherwise stated)													P O L A R I T Y	O U T L I N E S
	V _{CB0}	V _{CEO}	V _{EBO}	I _C	P _{tot}	T _j	h _{FE}	h _{FE} at	V _{CE}	I _C	f _T	C _{ob}	V _{CEsat}	I _C	I _B	F	V _{CE}	I _C	f			
	V	V	V	mA	mW	°C		at	V _{CE}	I _C	MHz	pF	V	mA	mA	dB	V	mA	MHz			
BF494	30	20	5	30	300e150		min - max	min		min	max	max	max	1	10	4	10	1	100	N	116a	

9784 1

oscillator and mixer stages in AM and FM receivers to HF and IF amplifier stages. However, there is a problem. As several observant readers have pointed out, the pinning shown in the transistor list in E17, p.947, is at variance with the pinning used on the Elektor printed circuit boards. As we mentioned in the 'Missing Link' last month, the information in the transistor list was incorrect; this has been corrected in the more recent lists. The reason for the slip is perhaps interesting. We took extreme care to keep the list in exact accordance with the 'Standard Handbook' issued by Pro-Electron. When the reader's enquiries started coming in, we compared the Pro-Electron data (figure 1) with the pinning shown in the Philips data handbook (figure 2). To our surprise we

2

SILICON PLANAR EPITAXIAL TRANSISTOR

BF494

Dimensions in mm

MECHANICAL DATA

TO-92 variant

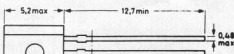
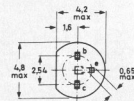

diameter within 2.5 max, is uncontrolled

9784 2

Type	PNP - P NPN - N	V _{CEO} (Volt)	I _c (max) (mA)	P _{max} (mW) not cooled: = < 300 = 25-40 = 45-60 = 65-80 00000 = > 85	h _{FE} (min)	case nr.	comments
TUN	N	0	00	0	0	000	
TUP	P	0	00	0	0	000	
AC126	P	0	0	0	0	0000	
AF239	P	0	0	0	0	1	grounded base: f _T = 700 MHz
BC107	N	0000	0	0	0	2	
BC108	N	0	00	0	0	2	
BC109	N	0	00	0	0	2	low noise
BC140	N	00	0000	00 ⁰	0	2	
BC141	N	000	0000	00 ⁰	0	2	
BC160	P	00	0000	00 ⁰	0	2	
BC161	P	000	0000	00 ⁰	0	2	
BC182	N	0000	000	0	0	0000	
BC212	P	0000	000	0	0	2	
BC546	N	0000	00	00	00	0000	
BC556	P	0000	00	00	00	2	
BD106	N	00	00000	00 ⁰	0	7	
BD130	N	000	00000	00 ⁰	0	7	
BD132	P	000	00000	00 ⁰	0	9	
BD137	N	000	0000	00 ⁰	0	9	
BD138	N	000	0000	00 ⁰	0	9	
BD139	N	0000	0000	00 ⁰	0	9	
BD140	P	0000	0000	00 ⁰	0	9	
BDY20	N	000	00000	00 ⁰	0	7	
BF180	N	0	0	0	0	1	grounded base: f _T = 675 MHz
BF194	N	0	0	0	0	12	grounded base: f _T = 220 MHz
BF194	N	0	0	0	0	10	grounded emitter: f _T = 260 MHz
BF195	N	0	0	0	0	10	grounded emitter: f _T = 200 MHz
BF199	N	00	0	00	00	11	grounded emitter: f _T = 550 MHz
BF200	N	0	0	0	0	1	grounded base: f _T = 240 MHz
BF254	N	0	0	0	0	11	grounded emitter: f _T = 260 MHz
BF257	P	00000	0	00	00	2	grounded emitter: f _T = 90 MHz
BF494	N	0	0	0	0	11	grounded emitter: f _T = 260 MHz
BFX34	N	000	00000	00	00	2	grounded emitter: f _T = 70 MHz
BFX89	N	0	0	0	0	1	grounded emitter: f _T = 1000 MHz
BFY90	N	0	0	0	0	1	grounded emitter: f _T = 1000 MHz
BSX19	N	0	0000	0	00	2	
BSX20	N	0	0000	0	00	2	
BSX61	N	000	0000	00	00	2	
HEP51	P	00	0000	00	00	1	f _T = 150 MHz
HEP53	N	00	0000	00	00	1	f _T = 200 MHz
HEP56	N	0	00	00	00	5	f _T = 750 MHz
MJE171	P	000	00000	00 ⁰	00	9	
MJE180	N	00	00000	00 ⁰	00	9	
MJE181	N	000	00000	00 ⁰	00	9	
MJE340	N	00000	0000	00 ⁰	00	9	
MPS A05	N	000	0000	00	00	13	
MPS A06	N	0000	0000	00	00	13	
MPS A09	N	0000	00	00	00	13	
MPS A10	N	00	00	00	00	13	
MPS A13	N	00	000	00	0000	13	
MPS A16	N	00	00	00	0000	13	
MPS A17	N	00	00	00	0000	13	
MPS A18	N	000	000	00	0000	13	
MPS A55	P	000	0000	0	00	13	
MPS A56	P	0000	0000	0	00	13	
MPS U01	N	00	00000	00 ⁰	00	14	
MPS U05	N	000	00000	00 ⁰	00	14	
MPS U06	P	0000	00000	00 ⁰	00	14	
MPS2926	N	0	00	00	00	13	f _T = 300 MHz
MPS3394	N	00	00	00	0000	13	f _T = 100 MHz
MPS3702	P	00	000	00	0000	13	f _T = 480 MHz
MPS3706	N	0	0000	00	0000	13	
MPS8514	N	00	00	0	0000	13	
TIP29	N	00	0000	00 ⁰	0	3	
TIP30	P	00	0000	00 ⁰	0	3	
TIP31	N	00	00000	00 ⁰	0	3	
TIP32	P	00	00000	00 ⁰	0	3	
TIP140	N	000	00000	00 ⁰	0000	7	Darlington
TIP142	N	00000	00000	00 ⁰	0000	7	Darlington
TIP2955	P	000	00000	00 ⁰	0	3	
TIP3055	N	000	00000	00 ⁰	0	3	
TIP3530	P	000	00000	00 ⁰	0	3	
2N696	N	000	0000	00	0	2	
2N706	N	0	0	0	0	2	
2N914	N	0	0000	00	00	2	
2N1613	N	000	0000	00	00	2	
2N1711	N	000	0000	00	00	2	
2N1983	N	00	0000	00	00	2	
2N1984	N	00	0000	00	00	2	
2N2219	N	00	0000	00	00	2	
2N2222	N	00	0000	00	00	2	
2N2925	N	00	00	0	0000	13	
2N2955	P	00	00	0	0	2	
2N3054	N	000	00000	00 ⁰	00	7	
2N3055	N	000	00000	00 ⁰	0	7	
2N3533	N	000	0000	00 ⁰	0	2	
2N3568	N	000	0000	0	0000	13	f _T = 500 MHz
2N3638	P	00	0000	0	0000	13	
2N3702	P	00	000	00	0000	13	
2N3986	P	00	000	00	00 ⁰	2	
2N3904	N	00	000	0	00	13	
2N3905	P	00	000	00	0000	13	
2N3906	P	00	000	00	0000	13	
2N3907	N	000	00	00	0000	13	
2N4123	N	00	000	0	00	13	
2N4124	N	00	000	0	0000	13	
2N4126	P	00	000	0	0000	13	
2N4401	N	000	0000	00	00	13	
2N4410	N	0000	000	00	00	13	
2N4427	N	0	000	00 ⁰	0	2	f _T = 700 MHz
2N5183	N	0	0000	00	000	2	

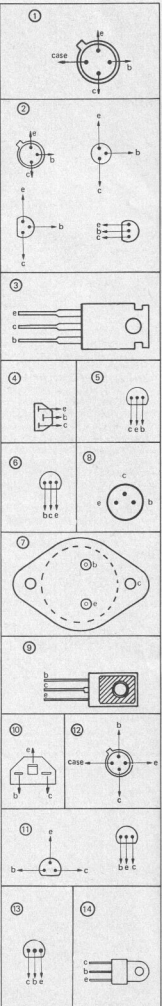

OPAMPS, COMPARATORS

703

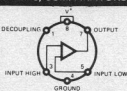

NOTE: Pin 4 connected to case

709

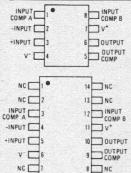

NOTE: Pin 7 connected to bottom of package.

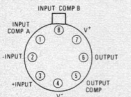

NOTE: Pin 4 connected to case.

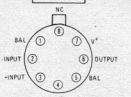
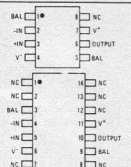

TAA 861 (A)

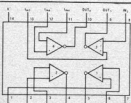
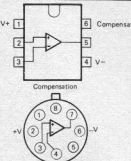

1458 (555S)

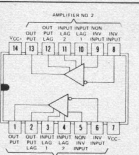

- Output A
- Inverting Input A
- Noninverting Input A
- V+
- Noninverting Input B
- Inverting Input B
- Output B
- V-

SN 76131 = BTA 231 = μ A 739

324

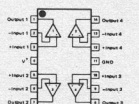

CA 3080

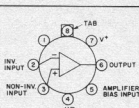

NOTE: Pin 4 is connected to case.

CA 3094

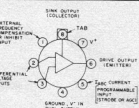

NOTE: Pin 4 is connected to case.

CA 3130

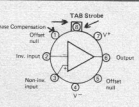

NOTE: Pin 4 is connected to case.

339 (3302)

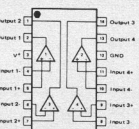

SPECIAL TYPES

CA 3096 = CA 3046

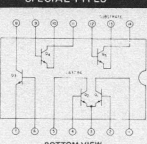

BOTTOM VIEW

LM309K

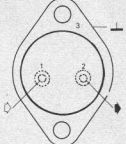

555

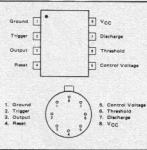

556

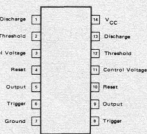

1310

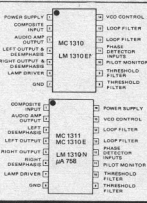

VOLTAGE REGULATORS

L 129/L 130/L 131

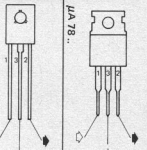

LA 78 -

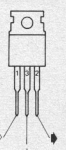

723 (550)

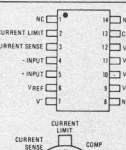

SG 3901 (SG 4501)

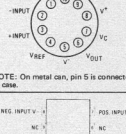

LM 325 (LM 125/LM 225)

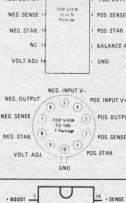

LM 309 H, LA 78 M.

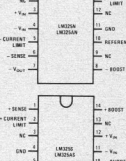

LM 309 H, LA 78 M.

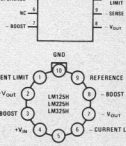

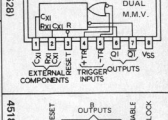
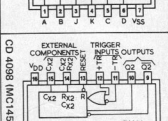
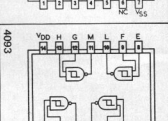
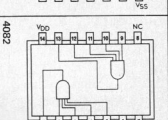
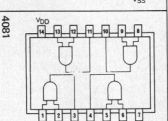
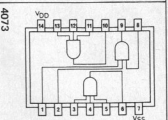
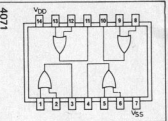
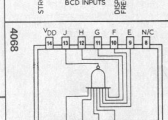
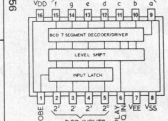
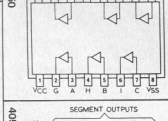
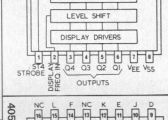
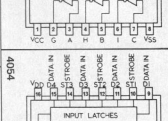
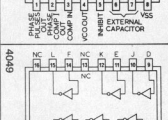
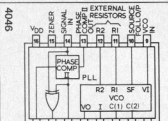
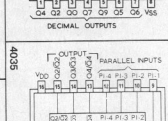
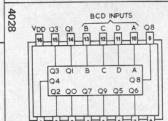
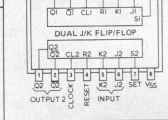
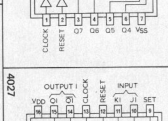
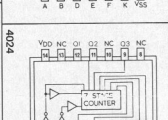
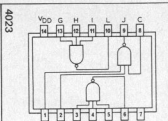
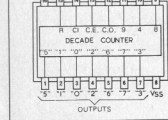
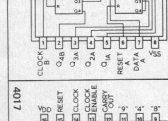
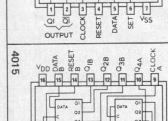
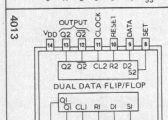
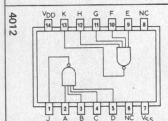
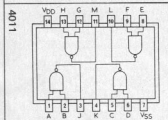
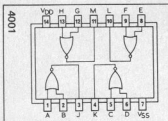

Note: A prefix to the type number denotes the manufacturer, e.g. CD 4001 (RCA), MC 14001 (Motorola), N 4001 (Signetics), SCL 4001 (Solid State Scientific), SIL 4001 (Sittek).

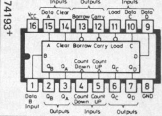
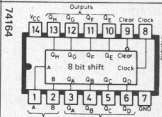
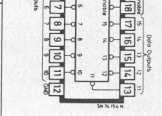
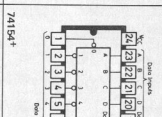
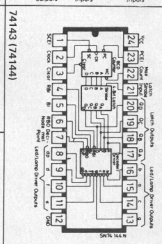
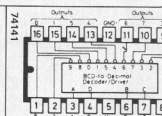
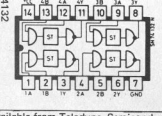
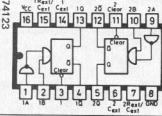
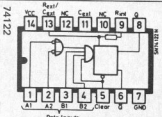
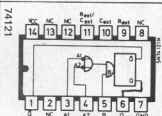
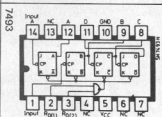
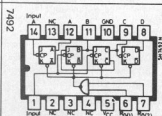
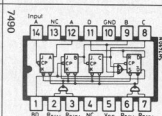
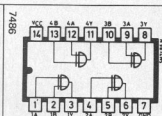
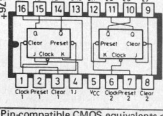
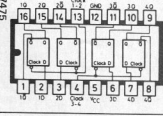
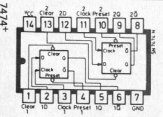
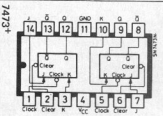
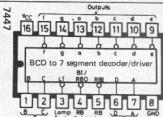
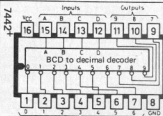
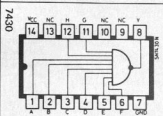
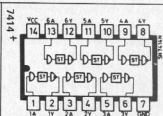
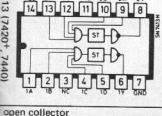
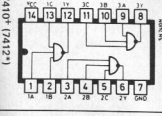
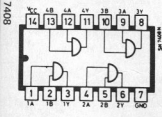
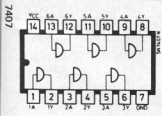
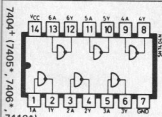
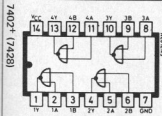
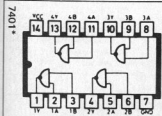
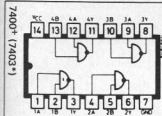

* open collector

* Pin-compatible CMOS equivalents available from Teledyne Semiconductor and National Semiconductor

TUP TUN DUG DUS

	type	U_{ce0} max	I_c max	h_{fe} min.	P_{tot} max	f_T min.
TUN TUP	NPN PNP	20 V 20 V	100 mA 100 mA	100 100	100 mW 100 mW	100 MHz 100 MHz

Table 1a. Minimum specifications for TUP and TUN.

	type	U_R max	I_F max	I_R max	P_{tot} max	C_D max
DUS DUG	Si Ge	25 V 20 V	100 mA 35 mA	1 μ A 100 μ A	250 mW 250 mW	5 pF 10 pF

Table 2. Various transistor types that meet the TUN specifications.

TUN		
BC 107	BC 208	BC 384
BC 108	BC 209	BC 407
BC 109	BC 237	BC 408
BC 147	BC 238	BC 409
BC 148	BC 239	BC 413
BC 149	BC 317	BC 414
BC 171	BC 318	BC 547
BC 172	BC 319	BC 548
BC 173	BC 347	BC 549
BC 182	BC 348	BC 582
BC 183	BC 349	BC 583
BC 184	BC 382	BC 584
BC 207	BC 383	

Table 3. Various transistor types that meet the TUP specifications.

TUP		
BC 157	BC 253	BC 352
BC 158	BC 261	BC 415
BC 177	BC 262	BC 416
BC 178	BC 263	BC 417
BC 204	BC 307	BC 418
BC 205	BC 308	BC 419
BC 206	BC 309	BC 512
BC 212	BC 320	BC 513
BC 213	BC 321	BC 514
BC 214	BC 322	BC 557
BC 251	BC 350	BC 558
BC 252	BC 351	BC 559

Table 1b. Minimum specifications for DUS and DUG.

Table 4. Various diodes that meet the DUS or DUG specifications.

DUS		DUG
BA 127	BA 318	OA 85
BA 217	BAX 13	OA 91
BA 218	BAY 61	OA 95
BA 221	1N914	AA 116
BA 222	1N4148	
BA 317		

Table 5. Minimum specifications for the BC107, -108, -109 and BC177, -178, -179 families (according to the Pro-Electron standard). Note that the BC179 does not necessarily meet the TUP specification ($I_{c,max} = 50$ mA).

	NPN	PNP
	BC 107 BC 108 BC 109	BC 177 BC 178 BC 179
V_{ce0} max	45 V 20 V 20 V	45 V 25 V 20 V
V_{eb0} max	6 V 5 V 5 V	5 V 5 V 5 V
I_c max	100 mA 100 mA 100 mA	100 mA 100 mA 50 mA
P_{tot} max	300 mW 300 mW 300 mW	300 mW 300 mW 300 mW
f_T min.	150 MHz 150 MHz 150 MHz	130 MHz 130 MHz 130 MHz
F max	10 dB 10 dB 4 dB	10 dB 10 dB 4 dB

The letters after the type number denote the current gain:

- A: α' (β , h_{fe}) = 125-260
 B: α' = 240-500
 C: α' = 450-900.

Wherever possible in Elektor circuits, transistors and diodes are simply marked 'TUP' (Transistor, Universal PNP), 'TUN' (Transistor, Universal NPN), 'DUG' (Diode, Universal Germanium) or 'DUS' (Diode, Universal Silicon). This indicates that a large group of similar devices can be used, provided they meet the minimum specifications listed in tables 1a and 1b.

For further information, see the article 'TUP-TUN-DUG-DUS' in Elektor 1, p. 9.

Table 6. Various equivalents for the BC107, -108, ... families. The data are those given by the Pro-Electron standard; individual manufacturers will sometimes give better specifications for their own products.

NPN	PNP	Case	Remarks
BC 107 BC 108 BC 109	BC 177 BC 178 BC 179		
BC 147 BC 148 BC 149	BC 157 BC 158 BC 159		$P_{max} = 250$ mW
BC 207 BC 208 BC 209	BC 204 BC 205 BC 206		
BC 237 BC 238 BC 239	BC 307 BC 308 BC 309		
BC 317 BC 318 BC 319	BC 320 BC 321 BC 322		$I_{c,max} = 150$ mA
BC 347 BC 348 BC 349	BC 350 BC 351 BC 352		
BC 407 BC 408 BC 409	BC 417 BC 418 BC 419		$P_{max} = 250$ mW
BC 547 BC 548 BC 549	BC 557 BC 558 BC 559		$P_{max} = 500$ mW
BC 167 BC 168 BC 169	BC 257 BC 258 BC 259		169/259 $I_{c,max} = 50$ mA
BC 171 BC 172 BC 173	BC 251 BC 252 BC 253		251...253 low noise
BC 182 BC 183 BC 184	BC 212 BC 213 BC 214		$I_{c,max} = 200$ mA
BC 582 BC 583 BC 584	BC 512 BC 513 BC 514		$I_{c,max} = 200$ mA
BC 414 BC 414 BC 414	BC 416 BC 416 BC 416		low noise
BC 413 BC 413	BC 415 BC 415		low noise
BC 382 BC 383 BC 384			
BC 437 BC 438 BC 439			$P_{max} = 220$ mW
BC 467 BC 468 BC 469			$P_{max} = 220$ mW
	BC 261 BC 262 BC 263		low noise

TUP TUN DUG DUS

order a subscription to elektor for 1977 now at 1976 prices

We regret that the cover price of ELEKTOR has been increased for 1977. BUT YOU CAN STILL subscribe to ELEKTOR for 1977 at £ 6.25*, so make sure you receive your copy regularly and in ADVANCE. Use the reply paid coupon, no stamp needed, and order your subscription now!

* £ 6.25 UK and overseas surface mail.

Look through this issue of ELEKTOR and you will find that ELEKTOR is not just one more Electronics magazine
ELEKTOR is different

. . . . different

- in its presentation
- in its style and content
- in its use of new techniques and components in practical circuits

. . . . PLUS

- An unequalled Printed Circuit Board Service
- Technical queries service
- and if you subscribe an additional circuit design in the mailing wrapper

ELEKTOR is the magazine for your profession, study or hobby. ELEKTOR avoids long-winded theoretical discussions and the like. Instead, it gives practical applications.

elektor binders

for your 1977 issues

The dark green binder collects your loose copies of ELEKTOR into one handy volume.

Each copy is fastened simply and firmly with a metal pin, and any copy can easily be removed later without disturbing the others.

Matching self-adhesive labels are provided to show the year.

ELEKTOR binders can be ordered from our Canterbury office using the form over-leaf.

Price: £ 1.85 (incl. VAT and p&p).

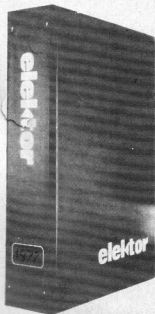

The new Maplin Catalogue is no ordinary catalogue...

Hundreds of fascinating new lines.

Several major new projects to build.

MAPLIN ELECTRONIC SUPPLIES

SUPERSONIC SAME DAY SERVICE!

QUALITY COMPONENTS FAST!

Just a tiny part of the extended range of capacitors and resistors. Our capacitor range includes non-polarised electrolytics! Our resistor range includes even 1%-tolerance types!



Another fascinating addition is the disco section - including a very high quality sound-operated light show to build - high power speaker and suitable cabinet - specifications of our build it yourself 100 W stereo disco - lighting effects projector and accessories.

Hundreds of photographs and illustrations.

Super Discount Scheme - save you pounds!

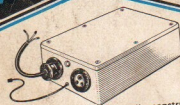

Projects section includes full construction details of a really low-cost, easy to build, highly effective electronic ignition system. Extremely reliable yet takes less than 10 seconds to switch to normal running if fault should occur.

Catalogue includes a very wide range of components: hundreds of different capacitors; resistors; transistors; I.C.'s; diodes; wires and cables; discotheque equipment; organ components; musical effects units; microphones; turntables; cartridges; styli; test equipment; boxes and instrument cases; knobs, plugs and sockets; audio leads; switches; loudspeakers; books; tools - AND MANY MANY MORE.

SEND THIS COUPON FOR **YOUR COPY OF OUR CATALOGUE ON APPROVAL!** Price 50p - SEND NO MONEY NOW. Please rush me a copy of your brand new 1977/78 catalogue the instant it is published. Only if I am completely satisfied that it is worth every penny, will I send 50p within 14 days of receipt. If I am not satisfied, I may return the catalogue to you within 14 days without obligation. I understand that I need not purchase anything from your catalogue should I choose to keep it.

NAME _____

ADDRESS _____

Maplin Electronic Supplies P.O. Box 3, Rayleigh, Essex, SS6 8LR



Our bi-monthly newsletter keeps you up to date with latest guaranteed prices - our latest special offers (they save you pounds) - details of new projects and new lines. Send 30p for the next six issues (5p discount voucher with each copy).

MAPLIN
ELECTRONIC SUPPLIES
P.O. BOX 3, RAYLEIGH, ESSEX SS6 8LR

Shop: 284, London Road, Westcliff-on-Sea, Essex
(Closed on Monday) Telephone: Southend (0702) 44101

Owing to delay in completion of larger warehouse, catalogue will be delayed by up to four weeks - so there's still time to order before publication and get your pack of ten super special offer coupons, giving big discounts on ten different popular items. **YOU COULD SAVE POUNDS! - SO DON'T DELAY - FILL IN AND POST COUPON NOW!**