

up-to-date electronics for lab and leisure

ELEKTOR 19



domestic circuits

Alvin Karp

November 1976 40p

elektor decoder

What is a TUN?
What is 10N?
What is the EPS service?
What is the TQ service?
What is a missing link?

Semiconductor types

Very often, a large number of equivalent semiconductors exist with different type numbers. For this reason, 'abbreviated' type numbers are used in Elektor wherever possible:

- '741' stands for μ A741, LM741, MC741, MIC741, RM741, SN72741, etc.
- 'TUP' or 'TUN' (Transistor, Universal, PNP or NPN respectively) stands for any low frequency silicon transistor that meets the specifications listed in Table 1. Some examples are listed below.
- 'DUS' or 'DUG' (Diode, Universal, Silicon or Germanium respectively) stands for any diode that meets the specifications listed in Table 2.
- 'BC107B', 'BC237B', 'BC547B' all refer to the same 'family' of almost identical better-quality silicon transistors. In general, any other member of the same family can be used instead. (See below.)

For further information, see 'TUP, TUN, DUG, DUS', Elektor 17, p. 948.

Table 1. Minimum specifications for TUP (PNP) and TUN (NPN).

$V_{CEO,max}$	20V
$I_{C,max}$	100 mA
$f_{\beta,min}$	100
$P_{tot,max}$	100 mW
$f_{T,min}$	100 MHz

Some 'TUN's are: BC107, BC108 and BC109 families; 2N3856A, 2N3859, 2N3860, 2N3904, 2N3947, 2N4124. Some 'TUP's are: BC177 and BC178 families; BC179 family with the possible exception of BC159 and BC179; 2N2412, 2N3251, 2N3906, 2N4126, 2N4291.

Table 2. Minimum specifications for DUS (silicon) and DUG (germanium).

	DUS	DUG
V_R,max	25V	20V
I_F,max	100mA	35mA
I_R,max	1 μ A	100 μ A
$P_{tot,max}$	250mW	250mW
C_D,max	5pF	10pF

Some 'DUS's are: BA127, BA217, BA218, BA221, BA222, BA317, BA318, BAX13, BAY61, 1N914, 1N4148.

Some 'DUG's are: OA85, OA91, OA95, AA116.

BC107 (-8, -9) families:
BC107 (-8, -9), BC147 (-8, -9), BC207 (-8, -9), BC237 (-8, -9), BC317 (-8, -9), BC347 (-8, -9), BC547 (-8, -9), BC171 (-2, -3), BC182 (-3, -4), BC382 (-3, -4), BC437 (-8, -9), BC4

BC177 (-8, -9) families:
BC177 (-8, -9), BC157 (-8, -9), BC204 (-5, -6), BC307 (-8, -9), BC320 (-1, -2), BC350 (-1, -2), BC557 (-8, -9), BC251 (-2, -3), BC212 (-3, -4), BC512 (-3, -4), BC261 (-2, -3), BC416.

Resistor and capacitor values

When giving component values, decimal points and large numbers of zeros are avoided wherever possible. The decimal point is usually replaced by one of the following international abbreviations:

p (pico-) = 10^{-12}
n (nano-) = 10^{-9}
 μ (micro-) = 10^{-6}
m (milli-) = 10^{-3}
k (kilo-) = 10^3
M (mega-) = 10^6
G (giga-) = 10^9

A few examples:

Resistance value 2k7: this is 2.7 k Ω , or 2700 Ω .

Resistance value 470: this is 470 Ω .

Capacitance value 4p7: this is 4.7 pF, or 0.000 000 000 004 7 F.

Capacitance value 10 n: this is the international way of writing 10,000 pF or .01 μ F, since 1 n is 10^{-9} farads or 1000 pF.

Mains voltages

No mains (power line) voltages are listed in Elektor circuits. It is assumed that our readers know what voltage is standard in their part of the world! Readers in countries that use 60 Hz should note that Elektor circuits are designed for 50 Hz operation. This will not normally be a problem; however, in cases where the mains frequency is used for synchronisation some modification may be required.

Technical services to readers

— **EPS service.** Many Elektor articles include a layout for a printed circuit board. Some — but not all — of these boards are available ready-etched and pre-drilled. The 'EPS print service list' in the current issue always gives a complete list of available boards.

— **Technical queries.** Members of the technical staff are available to answer technical queries (relating to articles published in Elektor) by telephone on Mondays from 14.00 to 16.30. Letters with technical queries should be addressed to Dept. TQ. Please enclose a stamped, self addressed envelope; readers outside U.K. please enclose an IRC instead of stamps.

— **Missing link.** Any important modifications to, additions to, improvements on or corrections in Elektor circuits are generally listed under the heading 'Missing Link' at the earliest opportunity.

ELEKTOR

19

Volume 2
Number 11

Editor : W. van der Horst
Deputy editor : P. Holmes
Technical editors : J. Barendrecht
G.H.K. Dam
E. Krempelsauer
G.H. Nachbar
Fr. Scheel
K.S.M. Walraven
Art editor : C. Sinke
Subscriptions : Mrs. A. van Meyel

UK editorial offices, administration and advertising:
6 Stour Street, Canterbury CT1 2XZ.

Tel. Canterbury (0227) — 54430.

Telex: 965504.

Bank: Midland Bank Ltd Canterbury A/C no. 11014587.

Sorting code 40-16-11, giro. no. 315 4254.

Assistant Manager and Advertising : R.G. Knapp
Editorial : T. Emmens

Elektor is published monthly on the third Friday of each month, price 40 pence.

Please note that number 15/16 (July/August) is a double issue, 'Summer Circuits', price 80 pence. Single copies (including back issues) are available by post from our Canterbury office to UK addresses and to all countries by surface mail at £ 0.55.

Single copies by air mail to all countries are £ 0.90.

Subscriptions for 1976 (January to December inclusive):

to UK addresses and to all countries by surface mail:

£ 6.25, to all countries by air mail £ 11.—.

All prices include p & p.

Change of address. Please allow at least six weeks for change of address. Include your old address, enclosing, if possible, an address label from a recent issue.

Letters should be addressed to the department concerned:

TQ = Technical Queries; ADV = Advertisements;

SUB = Subscriptions; ADM = Administration;

ED = Editorial (articles submitted for publication etc.);

EPS = Elektor printed circuit board service.

For technical queries, please enclose a stamped, addressed envelope.

The circuits published are for domestic use only. The

submission of designs or articles to Elektor implies

permission to the publishers to alter and translate the text

and design, and to use the contents in other Elektor

publications and activities. The publishers cannot

guarantee to return any material submitted to

them. All drawings, photographs, printed circuit boards and

articles published in Elektor are copyright and may not

be reproduced or imitated in whole or part without prior

written permission of the publishers.

Patent protection may exist in respect of circuits, devices,

components etc., described in this magazine.

The publishers do not accept responsibility for failing to

identify such patent or other protection.

National advertising rates for the English edition of Elektor

and/or international advertising rates for advertising at the

same time in the English, Dutch and German issues are

available on request.

Distribution: Spotlight Magazine Distributors Ltd,

Spotlight House 1, Bentwell Road, Holloway,

London N7 7AX.

Copyright © 1976 Elektor publishers Ltd — Canterbury.

Printed in the Netherlands.

contents

selektor	1108
albar	1110
Albar is an ultrasonic movement detector, based on the Doppler effect. It uses only one ultrasonic transducer as both transmitter and receiver. The circuit can be used as the basis of a burglar alarm, which could prove well worth the cost. It can also be used as a modern game of skill. The article also contains proposals for more elaborate alarm equipment.	
sensitive metal detector	1116
An unusual design approach was chosen for the circuit described here. With a little care, the average home constructor should be able to build a highly sensitive metal detector, which will be suitable for a wide variety of uses.	
egg-timer-with-a-difference - J. Schmitz	1119
Relatively few components are used in this egg timer. The 'boiling time' is automatically determined according to the size of the egg and the degree of hardness required.	
DEW line	1121
The Domestic Early Warning System (DEW line) will monitor various vital points throughout the house and give timely warning if anything goes wrong.	
pocketronics	1123
calendar - R. ter Mijtelen	1124
A circuit for producing a calendar display using the pulses from a digital clock has already been described in Elektor 8. This design provides an alternative circuit which gives day, date and month display, plus flashing display facility to draw attention to dates of particular interest.	
intercom	1128
A domestic intercom doesn't require a complicated circuit. The unit described here uses only a handful of components, even though an automatic gain control has been incorporated in the circuit.	
signal horn	1130
Although designed as a warning horn for use with the 'Albar' ultrasonic alarm system described elsewhere in this issue, the signal horn may of course be used with any system requiring an audible warning. The parts outlay is small but the sound produced is loud and extremely penetrating.	
voltage-to-time converter	1131
minivolt - A.M. Bosschaert	1132
In this age of digital things (?) it is nice to dress up the front panel of home-brew equipment with digital read-outs. This handsome little digital voltmeter is easy to build and is inexpensive.	
cricket - J. Schmitz	1133
Summer is long gone, and all of nature is proceeding through its autumnal eventide towards winter hibernation. Birds are departing, and the casual wanderer will notice the lack of animal and insect sounds in the hedgerows. A sad state of affairs ... However, electronics is coming to the rescue: in this article, we proudly present a cricket with a heart of CMOS!	
film slave - R.L.A. Trost	1135
The film slave is a sound activated switch originally intended to control a cine camera. However, with little or no modification it may also be used for a variety of other purposes, such as automatic starting of a tape recorder in response to sound.	
pulse generator - E. van Dee and B. Alberts	1138
A pulse generator is an extremely useful aid when testing and servicing logic circuits. The generator described here is uncomplicated and is based on TTL IC's, but the facilities provided are quite comprehensive.	
missing link	1140
coming soon	1140
refrigerator alarm	1141
This unit will sound the alarm if the door of a refrigerator is left open too long. Very few components are required for this effective food-and-energy-saver. It can be used either as a self-contained unit or as part of the 'Domestic alarm' described elsewhere in this issue.	
capacitance coupling	1142
In this article an electrostatic system is described which can be used as part of a sophisticated light dimmer.	
reading-in-bed limiter	1145
At a certain age, children are often packed off to bed with the final admonition, 'All right, you can read in bed for a quarter of an hour, but then you must turn off the light and go to sleep'. However, as most parents will know, the children tend to suddenly lose all sense of time in this situation ... When a member of the Elektor design team was faced with this problem, he started looking for an electronic solution. The final circuit, as published here, has proved extremely effective.	
a LOGICAL replacement for the carbon-track potentiometer	1147
market	1153

ELEKTOR BACK ISSUES ARE STILL AVAILABLE

This is a selection from the contents of the various issues:

number 1:

- tup-tun-dug-dus
- equa amplifier
- mos clock
- distortion meter
- tap sensor
- electronic loudspeaker
- steam whistle

number 2:

- minidrum
- universal display
- di1 led probe
- tv sound
- big ben
- modulation systems
- how to gyrate

number 3:

- tap preamp
- pll systems
- fido
- time machine
- compressor
- disc preamp
- a/d converter
- led displays

number 4:

- tup-tun tester
- interference suppression in cars
- thief suppression in cars
- supplies for cars
- cybernetic beetle
- the moth
- quadro in practice

number 5:

'Summer Circuits' issue, with over 100 circuits: amplifiers, generators, dividers, universal frequency reference, improved 7-segment display, receivers, power supplies, rhythm generators, measuring equipment, etc.

number 6

- edwin amplifier
- versatile digital clock
- phasing
- disco lights
- ota
- dual slope dvm
- car clock

numbers 7 and 8

sold out

number 9

- feedback pll for fm
- function generator
- racing car control
- simple mw receiver
- digital master oscillator
- pll-ic stereo decoder

number 10

- call sign generator
- morse decoder
- speech processor
- morse typewriter
- digital wrist watch

number 11

- tv tennis extensions
- sab receiver
- tv sound front-end adapter
- dynamic noise limiter
- integrated voltage regulators

number 12

- preco
- ic rhythm generator
- polaroid timer
- led meters
- stylus balance

number 13

- integrated indoor fm aerial
- equin (2)
- digisplay
- versatile logic probe

number 14:

- a.m. mains intercom
- fet probe
- vhf fm reception
- led light show
- digibell

number 15/16:

'Summer circuits' issue, with over 100 circuits.

number 17:

- m.p.g. indicator
- ignition timing strobe
- car service meter
- windscreen wiper delay
- rev counter

number 18:

- time on tv
- score on screen for tv games
- sq decoder
- digits on tv
- dual regulators
- fm on 11 meters



albar



Albar is an ultrasonic movement detector, based on the Doppler effect. It uses only one ultrasonic transducer as both transmitter and receiver. The circuit can be used as the basis of a burglar alarm, which could prove well worth the cost. It can also be used as a modern game of skill. The article also contains proposals for more elaborate alarm equipment.

Alarm equipment based on ultrasonics has several advantages over other types. Typically, it is quick and simple to install, and its sensitivity can be limited as required. However, it is not the purpose of this article to conduct a survey of available alarms, merely to provide a design for a particular one.

When discussing ultrasonic movement detectors, it is necessary to distinguish between two basic principles of operation, viz:

1. circuits which detect the interruption of an ultrasonic beam, and
2. circuits which detect the movement of an object within a given area.

Method (1) is shown in block diagram form in figure 1a.

The area that can be protected by this sort of device is very limited, so this method is usually employed in situations where the securing of one door or window protects a larger area.

A block diagram of a movement detector is shown in figure 1b. In this case, it is not necessary for the transmitter and the receiver to be opposite each other (i.e. on the same 'acoustic' axis), since the operation is based on the Doppler effect. This effect occurs when the sound source and the receiver are not stationary, but move either towards or away from each other. The most familiar example of this is to stand beside a railway line and listen to a train as it passes. The sound of the approaching train appears to the listener to be at a higher frequency than the sound of it receding. The effect can be defined as a frequency shift in the signal, if the

source and receiver are moving relative to one another. The effect can be useful in the field of ultrasonics.

The receiver (transducer) is the target for a fixed frequency signal which originates at the transmitter and is reflected by stationary objects. The signal reflected from a moving object will have a different frequency, due to the Doppler effect, and this signal will also be picked up by the receiver.

As a result of interference between the two signals, an amplitude fluctuation of the transmitted signal (i.e. 'beating') occurs. This fluctuation is detected and is used, eventually, to operate the alarm.

The effective range of such a movement detector can be considerable, although this is not always desirable. If the sensitivity is too high, then flying and even crawling insects, flexing doors and windows (in windy weather), and even air circulation can set off the alarm. If the movement detector is equipped with a sensitivity adjustment, then the 'operational range' can be matched not only to the space conditions but also to the object to be detected. The circuit is then universally applicable.

To achieve a useful range, the two transducers (transmitter and receiver) must be placed at a considerable distance from one another. Consequently, amplification of the signal by the receiver must be very high, before it is useful to the detector stage. A suitable receiver circuit is shown in figure 2. The transmitter is shown in figure 3. Both parts of the circuit can be supplied by the common power supply given in figure 4. The purpose of the nickel-cadmium accumulators and the calculation for the resistor R_x are given later. The transducer converts the ultrasonic signal into an electrical signal, which is then fed to a two-stage amplifier with T1 and T2 (see figure 2). The detector stage, based round T3, is followed by another two-stage amplifier (T4 and T5). The signal at the collector of T5 is used to drive the multivibrator consisting of T6 and T7. This in turn drives the final amplifier stage to which the alarm is connected. The output of T9 is rectified by the 1N4148 diodes and is fed back to the base of T5 to bias it on and thus latch on the alarm. The alarm may be reset by switching off the power supply and then switching it on again.

The circuit requires a fair number of components and, unfortunately, it is not possible to simplify it very much by using integrated circuits. This is due to the fact that the signal level as far as T4 is so low that conventional operational amplifiers are unsuitable. The worst problem is the threshold detector. A simplification is, however, possible if the principles of utilising the Doppler effect are reconsidered. The ultrasonic signal from the transmitter and the frequency-shifted signal give rise to interference. This results in an amplitude fluctuation, the frequency of which is the difference between the frequencies of the two signals: the 'beat frequency'. Interference will also occur if the ultra-

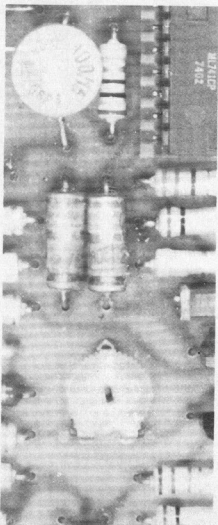

Figure 4. Power supply for the receiver and transmitter of figures 2 and 3.

Figure 5. Block diagram of Albar.

Figure 6. Complete circuit diagram for the movement detector, Albar. Note the saving of components over the circuits of figures 2 and 3.

Figure 7. To adjust the oscillator amplitude, connect a universal meter as shown here.

Figure 8. A complete alarm system with four detectors, as an illustration. This hybrid diagram (both block and wiring) is presented to indicate clearly the interconnections between the various circuits, including the Signal Horn. The mains unit can supply about ten Albar circuits and in most cases the Signal Horn can be powered as well as the alarm relay.

sonic signal which hits a moving object (figure 5). Some of the reflected signal, which has a different frequency from the original, arrives back at the transducer. Due to interference between the two signals, a signal which varies in amplitude occurs at the output of the receiver. This is then fed to the envelope detector; a lowpass filter removes the higher frequency components. The resulting LF signal is amplified, with the amount of amplification adjustable to match the required application. The amplified signal is then rectified and fed to a flip-flop which sets the alarm.

The circuit

The first stage (T1 and T2) in figure 6

acts as both transmitter and receiver, with the interference signal appearing at the emitter of T2. This stage is basically an emitter-coupled multivibrator. The ultrasonic transducer is situated between the emitters of the two transistors where it serves to set the frequency of the multivibrator. R5 and C3 are selected to force the transducer to its resonant frequency, so that harmonics, which are often present with this type of transducer, are eliminated. This filter should prove adequate if the Murata transducers (specified in the parts list) are used. However, with some other transducers it has proved necessary to use a 2.2 mH coil in place of R5 (e.g. Toko type EL 0810-222k).

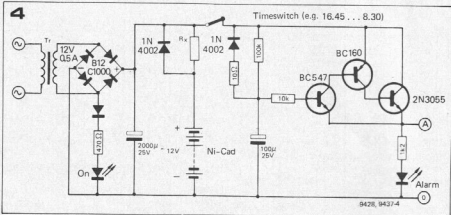

5



6

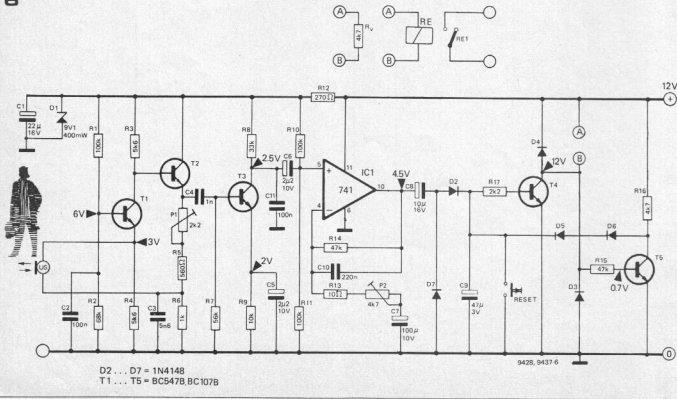

The transistor T1 is an amplifier stage for the reflected signal and T2 is an emitter follower. Although it might theoretically be possible to equip this stage with only one transistor, practical difficulties occur particularly in relation to the higher frequency resonance points of the ceramic transducer.

T3 is a detector stage in which the transistor has no bias voltage or current preset at its base, i.e. it is class C. It is only the positive half wave which is amplified, provided the signal amplitude is sufficient to raise the transistor above its threshold. The voltage which appears across C11 is dependent on the control signal voltage, so that modulation of the control signal (moving object) appears

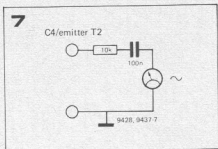

as a voltage change across C11.

The LF signal is amplified by IC1. The amplification is adjustable with P2. To eliminate any traces of the carrier still present after the first low pass filter (C11), the feedback to the opamp is fre-

quency dependent (C10). The next stage is a voltage doubler consisting of two diodes, D2 and D7, and two capacitors C8 and C9.

The final stage is a discrete component flip-flop, T4 and T5. It requires a control signal amplitude of about 0.7 V. An alarm can be directly connected between points A and B; alternatively, a relay which controls the alarm can be connected instead. The current consumption of the load should not exceed 20 mA.

Putting the circuit into operation

Connect the supply voltage and then measure the oscillator voltage with a suitable AC voltmeter, as shown in

8

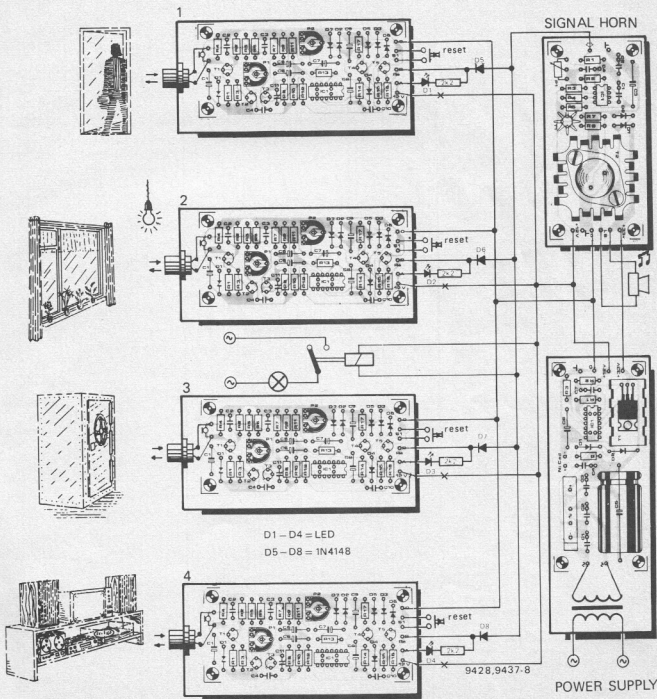

D1 - D4 = LED
D5 - D8 = 1N4148

9428, 9437-8

POWER SUPPLY

figure 7. Adjustments are carried out as follows:

1. adjust P1 to the maximum reading;
2. re-adjust P1 so that the reading drops to two-thirds of this maximum;
3. adjust the overall sensitivity of the circuit with P2.

The voltage values marked on the circuit apply only to the quiescent state, i.e. no alarm.

Construction and application

The circuit, together with the transducer, should be housed in a metal casing. Three external connections are required:

1. supply voltage;
2. reset to the circuit;
3. connection to the switch contact relay.

The relay is not required if the 'Signal Horn' circuit described elsewhere in this issue is used. The relay can then be replaced by a 4k7 resistor, and the diodes D3 and D4 are not required. Point B is then connected to the Signal Horn circuit (screened leads are not necessary).

As an example, figure 8 shows an installation consisting of four detector circuits, a Signal Horn and an alarm relay.

A system of multiple movement detectors can be arranged in two ways:

1. every entrance to an area is protected by a separate detector circuit;
2. each room which should not be entered by an intruder is protected by a circuit.

The second method is usually the cheaper, especially where none of the rooms in question are larger than the average-sized living room.

When the supply voltage is switched on, the alarm operates immediately, which at least enables you to know that it is working. If the noise is not required at switch-on, then the reset should be operated at the same time. The light-emitting diodes (D1 to D4) give a visual indication of the state of the alarm circuits.

It is usual to hide such switches as the on/off and the resets, but this is a matter of choice and may not always be convenient. For instance, it may be useful where various rooms in a house are protected, for the controls to be situated in the bedroom.

In the case of larger installations, it may be necessary to be able to put some of the units out of operation temporarily. In the case of Albar, this is done by breaking the supply lead at the points shown by crosses in figure 8.

The mains supply unit shown in figure 8 is given in detail in figure 11. It supplies 33 V for the Signal Horn. To enable the alarm to function even during a power cut (either accidental or deliberate) accumulators are included as stand-by power supply. Whenever the supply voltage from the mains is on, the accumulator draws current equal to its leakage current. The internal discharge is approximately one hundredth of the value of the accumulator capacity (in ampere hours).

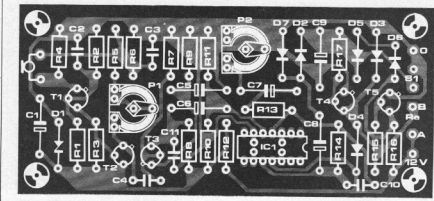
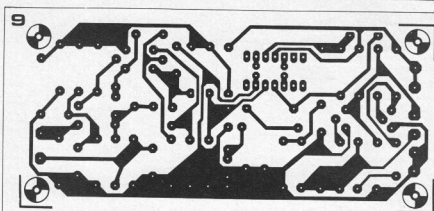

Parts list for figure 6.

Resistors:

R1, R10, R11 = 100 k
 R2 = 68 k
 R3, R4 = 5k6
 R5 = 560 Ω
 R6 = 1 k
 R7 = 56 k
 R8 = 33 k
 R9 = 10 k
 R12 = 270 Ω
 R13 = 10 Ω
 R14, R15 = 47 k
 R16 = 4k7
 R17 = 2k2
 R1 = 2k2 trimmer
 P2 = 4k7 trimmer

Capacitors:

C1 = 22 μ 16 V
 C2, C11 = 100 n
 C3 = 5n6
 C4 = 1 n
 C5, C6 = 2 μ 2/10 V
 C7 = 100 μ /10 V
 C8 = 10 μ /16 V
 C9 = 47 μ /3 V
 C10 = 220 n

Semiconductors:

T1 ... T5 = BC547B, BC107B,
 2N3904
 D1 = 9V1, 400 mW zener
 D2 ... D7 = 1N4148
 IC1 = 741 (DIL, Mini DIP or TO5)

Miscellaneous:

US = Ultrasonic transducer,
 Murata MA40L1R or MA40L1S
 RE = Relay 12 V/20 mA max.

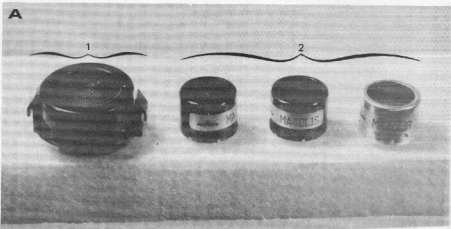
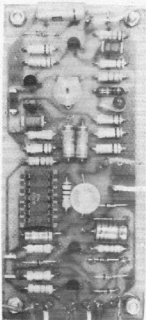

For the calculation of the value R_x , the following formula therefore applies:

$$R_x \approx \frac{1.5 \times V_{Tr} - V_{NiCad}}{0.01 \times I_{Ah}}$$

where

V_{Tr} = secondary voltage of the mains transformer;

V_{NiCad} = nominal voltage of the accumulator;

I_{Ah} = accumulator capacity in amp-hours.

In the event of a mains failure, the circuit receives its supply voltage via D2. Under these conditions, the noise output of the signal horn is perceptibly, but not drastically, reduced. If the Signal Horn is not switched on, then the current consumption is less than 15 mA. A small accumulator with a capacity of 100 mAh should be sufficient for most applications.

Note that it is highly recommended to inform the local police how to put the alarm out of action.

Use of the circuit as a game of skill

The circuit detects movements. It can therefore be used as a game of skill by attempting to 'beat' the detector by moving very slowly. The winner must exercise good muscle control in order to move sufficiently slowly. An element of luck is involved, however, since involuntary movements and reflexes will activate the alarm if the sensitivity is high enough.

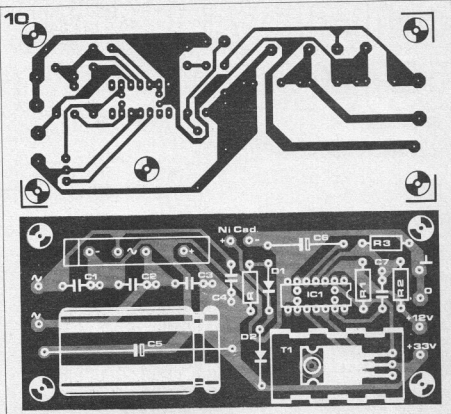

Figure 9. Printed circuit board for Albar (EPS 9428).

Figure 10. Printed circuit board for the mains unit of figure 11. It is capable of supplying the Signal Horn in addition to the detector circuits (EPS 9437).

Figure 11. Mains unit for the Albar(s) and the Signal Horn (which requires the 33 V supply).

Photo A. Some ultrasonic transducers. The Murata types (group 2 on the photo) are highly recommended. Other types (like the first one on the photo) may not be suitable in this circuit.

Parts list for figure 11.

Resistors:
 R1 = 1 Ω
 R2 = 3k3
 R3 = 4k7
 R_x = see text

Capacitors:
 C1 ... C4 = 100 n
 C5 = 2200 μ/40 V
 C6 = 47 μ/10 V
 C7 = 100 p

Semiconductors:
 T1 = BD241A, MJE3055
 D1, D2 = 1N4002, BY188
 IC1 = 723

Miscellaneous:
 Tr = Transformer, 24 V/1.5 A
 NiCad Accumulator, 18 V (see text)



11

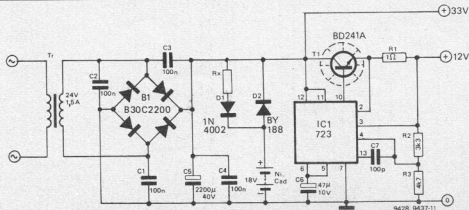

SENSITIVE METAL DETECTOR



Several readers have asked us to design a good metal detector. When our 'research and development' group took a closer look at the problem, they soon discovered why: most conventional designs are not really suitable for the home constructor!

In most designs, extreme care must be taken to screen the various sections of the circuit from one another and the power supply must be carefully filtered.

A different design approach was chosen for the circuit described here. With a little care, the average home constructor should be able to build a highly sensitive metal detector, which will be suitable for a wide variety of uses.

The normal way to construct a metal detector is to have two oscillators working on the same frequency. One of these is crystal controlled, and the other is connected to the pick-up coil (figure 1). The output of the two oscillators is fed to a mixer stage. When both oscillators are working at exactly the same frequency, the difference frequency is zero. However, when a metal object is brought into the vicinity of the pick-up coil the frequency of the VFO will change. This

causes a 'beat' frequency to appear at the output of the mixer. This is filtered and amplified, and fed to a headphone. So far so good, or so one would think. The difficulty with this system is that the slightest amount of coupling between the two oscillators will 'pull' the VFO into lock with the crystal oscillator. When this is the case, quite a hefty lump of metal is required to get an audible indication.

A further problem is that the coil

determines the frequency of the VFO. It has to be wound exactly according to specification, or else the tuning range of the VFO will not include the frequency of the crystal oscillator. Changing coils can be a major problem.

Both of these problems can be resolved to a very large extent by resorting to a different design approach. This is shown in the block diagram (figure 2) and the practical circuit (figure 3).

In the Elektor design the crystal oscillator has been replaced by a less expensive ceramic filter oscillator. The oscillation frequency is determined by a 455 kHz filter in the feedback path of T1. Granted, this oscillator will not be as stable as a crystal controlled unit but it is sufficiently stable for the purpose. The output from this oscillator is passed to a divide-by-10 stage (IC1), which will now deliver a 45.5 kHz square wave.

This output is passed through two pulse shapers in cascade (C4, R6, N1 and C5, R7, N2). This produces very short pulses with a repetition frequency of 45.5 kHz. This signal has a spectrum which extends well into the megahertz range, with 'spikes' every 45.5 kHz. Each spike can be used to produce a beat frequency with the VFO. This signal is passed to the mixer stage (T2). The main components of the VFO are T4, C17, C18 and the frequency determining components C_T and L_S , the search coil. It oscillates at a very high frequency. As an example, if the search coil is made of three turns on a 3 inches diameter form, the frequency can be adjusted to approximately 3.5 MHz. This signal is fed to the mixer, through a buffer stage (T3).

The output from the mixer stage is passed through a low-pass filter and an amplifier to the headphones. The active devices used in these stages are gates N3 and N4, biased to work as 'linear' amplifiers.

Since the 'fixed frequency reference' produces a broad spectrum, it is not difficult to find a 'zero beat' setting of the VFO. This has the added advantage that changing coils becomes a simple matter: there are so many spikes in the reference spectrum that almost any coil will produce a beat frequency somewhere within the tuning range. In practice, there will be 'loud' and 'soft' zero beats; obviously, it is advisable to select a loud and obvious one.

The coil diameter will depend on the

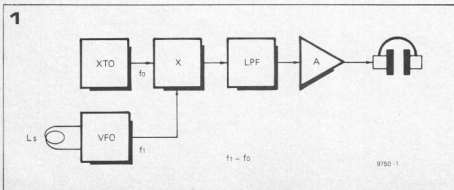
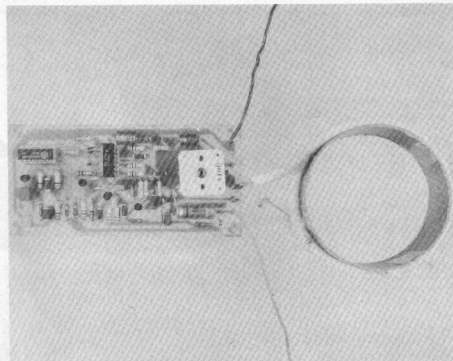
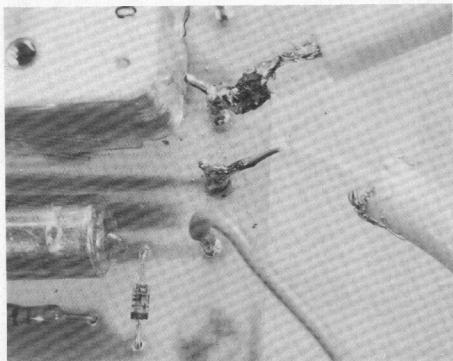
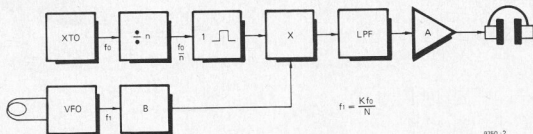

Figure 1. Block diagram of a conventional metal detector. The VFO is set at the same frequency as the crystal oscillator.

Figure 2. Block diagram of the metal detector described here. The output from the crystal oscillator is divided down to a lower frequency and then fed to a pulse shaper, producing a very broad spectrum of reference frequencies.

2



purpose for which the detector is to be used: a large coil is useful for approximate location of relatively large objects, whereas a small coil can be used to pinpoint the exact position of even a small object. The coil former can be plastic tube, up to the maximum tube diameter available (8 to 10 inches). For larger coils it becomes more difficult – but who says a coil must be round? A square section is also quite permissible. The best material to use for the coil is screened cable or coax, with a closely-wound screening braid. The core is used for the coil, and the screen is connected at one end to supply common. Remember, the coil is supposed to respond to a *magnetic* field change – it is not supposed to pick up short-wave transmissions!

The value of the tuning capacitor (C_T) is not critical. Any trimmer that will fit on the board and has a value between 100 p and 350 p should be suitable.

The construction of the whole circuit, including the coil, must be mechanically rugged. This is one of the reasons for using a p.c. board.

Using the detector

Several 'field tests' have shown that this metal detector is quite sensitive. For instance, a very small piece of metal was buried at a depth of over 6 inches. When the metal detector was used to search in the general area indicated, a large number of objects were located – including several orange-coloured (ferrous?) stones . . . In another test, the position of an old brass farthing was accurately pin-pointed under a two-inch thick pile of papers.

The metal detector has also proved useful for locating electrical wiring conduits and the like in the walls of a house.

Results will depend, of course, on the skill of the operator. In general, the following rules should be observed:

1. Start with a relatively large search coil. Hold it close to the ground (or wall) and tune in to a loud and obvious zero-beat.
2. Search the area in slow parallel sweeps (like mowing the lawn on a small scale). If you have ever seen it done on TV you will know exactly

3

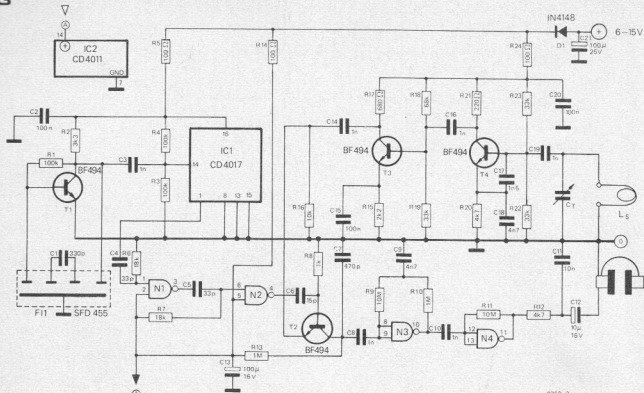

4

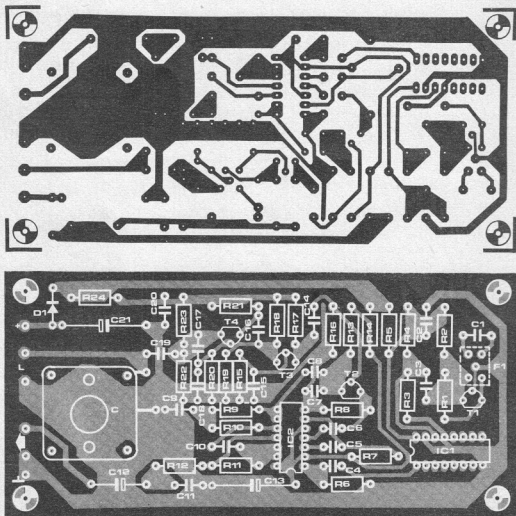

Figure 3. Circuit diagram of the metal detector.

Figure 4. Printed circuit board and component layout for the circuit shown in figure 3.

what is meant.

- A change in tone indicates 'something'. This 'something' can be an object, but it can also be that the distance between the metal detector and the ground is not held constant. If several sweeps in the same area give the same indication, there is probably something there. A relatively sudden change in tone means that the object is close to the surface, whereas a gradual change in tone indicates an object at greater depth.
- In the general area indicated by the last sweep, try a further search pattern at right-angles to the previous one. This will narrow the possible position down even further.
- In some cases (specifically, if the object is small) it is advisable to switch to a smaller coil at this point. Repeat the search procedure described above within the general area already found. It should be possible to get a quite accurate indication of the position of the object. M

Parts list.

Resistors:

R1, R3, R4 = 100 k
 R2 = 3k3
 R5, R14, R24 = 100 Ω
 R6, R7 = 18 k
 R8 = 1 k
 R9, R11 = 10 M
 R10, R13 = 1 M
 R12, R20 = 4k7
 R15 = 2k2
 R16 = 10 k
 R17 = 680 Ω
 R18 = 68 k
 R19, R22, R23 = 33 k
 R21 = 220 Ω

Capacitors:

C1 = 330 p
 C2, C15 = 100 n
 C3, C8, C10, C14, C16, C19 = 1 n
 C4, C5, C20 = 33 p
 C6 = 15 p
 C7 = 470 p
 C9, C18 = 4n7
 C11 = 10 n
 C12 = 10 μ /16 V
 C13, C21 = 100 μ /16 V
 C17 = 1n5
 C7 = 300 p trimmer (see text)

Semiconductors:

T1, T2, T3, T4 = BF 494
 IC1 = 4017
 IC2 = 4011
 D1 = 1N4148

Sundries:

Fl 1 = SFD455
 L_S = search coil, see text.

eggtimer-with-a-difference

J. Schmitz



Relatively few components are used in this eggtimer. The 'boiling time' is automatically determined according to the size of the egg and the degree of hardness required.

Eggtimers range from miniature hour-glasses to sophisticated digital clocks. The more modern versions usually give an audible indication that the allotted time has elapsed. The timer described here differs from all conventional units in that there is no time scale on it. Instead, there are two scales that are used to set the timer; one is calibrated in egg sizes (from 'canary' through 'hen' to 'ostrich') and the other in degrees of hardness (from 'runny' through 'medium' to 'bullet').

The timing interval is started by touching a TAP sensor; this is indicated by an LED lighting up. At the end of this period the unit produces a distinctly audible tone, signalling that the egg has been in hot water long enough. After a short time this tone is switched off and the unit puts itself completely out of action: the current consumption drops to zero. There is no need for a switch.

The circuit

The complete circuit (figure 1) consists of two main parts: the timer proper (T1...T4, with associated components) and the warning tone generator (T5...T7).

The timing sequence is started as soon as the TAP sensor is touched. Sufficient current passes through the skin resistance to turn on T3, and this transistor drives T4 into saturation. The timing circuit is now under power, and LED D1 lights up.

For a very short time, a charging current flows through C1 into the base of T1. This drives T1 into saturation, charging

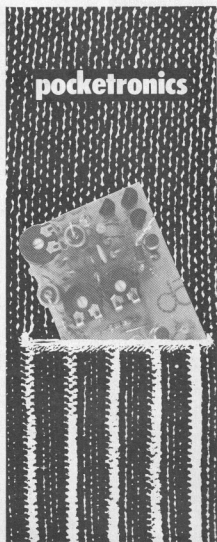

1

Parts list

Resistors:

R1 = 100 Ω
 R2 = 33 k
 R3, R6 = 1 M
 R4 = 1 k
 R5, R8 = 15 k
 R7, R9 = 330 k
 R10 = 10 k
 R11 = 3k9
 R12 = 5k6
 P1 = 1 M (preset)
 P2 = 100 k (preset)
 P3 = 4k7 (preset)

Capacitors:

C1 = 1 μ /4 V
 C2, C4 = 100 μ /4 V
 C3, C5 = 3n3

Semiconductors:

T1, T7 = BC107B
 T2, T3 = BC517
 T4... T6 = BC177B
 D1 = LED
 D2 = DUS

Sundries:

2 miniature mercury batteries, 1.2 V
 dynamic microphone,
 Sennheiser type HM35

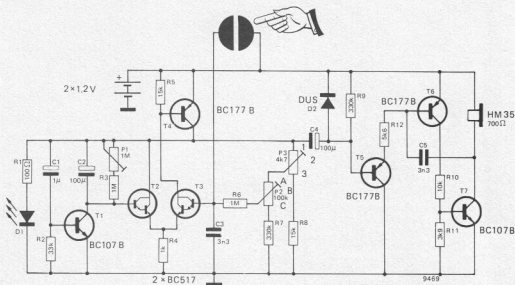

C2 rapidly. When C1 is fully charged, T1 turns off and C2 starts to discharge through R3 and P1.

Initially, T2 is turned off and T3 is conducting. As C2 discharges, the base voltage of T2 rises. After a certain time T2 will start to conduct, the voltage across R4 increases and T3 is turned off. This happens as soon as the voltage at the base of T2 has become equal to that at the base of T3 (T2 and T3 form a so-called 'long-tailed pair'). The latter voltage depends on the setting of P2 and P3.

When T3 stops conducting, T4 is also turned off. The supply voltage to the timer proper now falls away (the collector voltage of T4), and this voltage drop is passed via C4 to the oscillator circuit. T5 is turned on, enabling the oscillator proper (T6 and T7). This produces the tone which signals 'egg ready'.

C4 now starts to charge through the timer circuit on the one side and R9 on the other. After a short time, it will have charged so far that T5 is no longer held in conduction. When this transistor stops conducting, the oscillator is also turned off.

The timer can be re-used immediately: C1... C3 are already discharged sufficiently, and C4 will be discharged via D2 and T4 as soon as the TAP sensor is activated.

Calibration

Start with P2 and P3 in the mid-positions ('B' and '2', respectively). Now try a 'dry run' — i.e. no water and no egg — to see how many minutes the

2

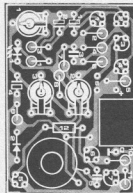
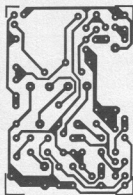

Figure 1. The egg timer with a difference. There are three timing adjustments: P1 is preset for normal boiling of average-sized eggs; P2 is for setting the consistency required ('runny' to 'bullet') and P3 is to compensate for differing egg sizes.

Figure 2. Printed circuit board and component layout.

timing interval is. If this interval is shorter than required for boiling a medium-sized egg to a medium degree of hardness, the resistance of P1 should be increased (turn the slider clockwise). If the time is too long, P1 should be turned the other way.

After several dry runs, the correct setting of P1 should have been found. It is left in this position, and P2 and P3 can be used to vary the timing according to taste (P2) and/or size of the egg (P3). Position 'A' of P2 corresponds to 'hard as a bullet' whereas position 'C' is for 'runny', position '1' of P3 is for over-sized eggs, and position '3' is for the miniaturised kind.

DEW LINE



The washing machine starts to leak while you're watching TV

Or the freezer fails and you don't notice it for a day or two

Or the children turn on the taps in the bath and leave them running

In all these cases, and many more, some form of Domestic Early Warning System (DEW line) can prevent more or less serious consequences.

What is required is a system that will monitor various vital points throughout the house and give timely warning if anything goes wrong.

A very simple alarm line is described here.

In spite of its extreme simplicity, this alarm system will prove quite adequate in many cases.

The alarm line proper consists of a sufficient length of three-core cable. Either three-core mains cable or two-core screened cable can be used. The alarm sensors and the receiving station (or stations) can be connected to this cable at any point along its length.

The electronics required are very simple, because the system works on the principle of audible recognition. In other words, the sophisticated sound recognition system which is part of human hearing is used as part of the alarm system.

To be more specific, the alarm sensors each produce a different warning tone if something goes wrong. They are all connected to the three-core cable. The receiving station is nothing more than a two-transistor audio amplifier. As soon as one of the alarm sensors registers the fact that something is wrong (the bath is running over, the deep-freeze is becoming too warm, etc.) it puts its own unique alarm tone on the line. This tone is reproduced by all the receiving

stations. It is up to the listener to decide from the frequency and repetition rate which alarm sensor it is.

In this article, alarm sensors for water leaks and for deep-freezers will be described. The refrigerator alarm described elsewhere in this issue can also be connected into the DEW line. In the "Summer Circuits" issue (Elektor 15/16) a 'Bell extender' was described, including a telephone bell pick-up. This, too, can be connected into the alarm system.

Alternatively, any or all of these sensors can be connected into the original 'Wireless bell extender' circuit (Elektor 15/16, circuit 52), if one is not inclined to run three-core cable all over the house.

Deep-Freeze alarm

The first 'domestic calamity sensor' to be described is a unit that produces an intermittent warning 'bleep' if the temperature inside the deep-freeze becomes so high that the food is in danger of thawing out.

The circuit is shown in figure 1. Only a single COSMOS integrated circuit and a good half-a-dozen other components are required. The four NAND gates in the IC are used in two multivibrators: N3/N4 produce an audible tone, and N1/N2 produce a very low frequency square wave. This low frequency oscillation is used to turn the audible tone oscillator (N3/N4) on and off, producing an intermittent 'bleeping'.

As long as the temperature of the NTC is sufficiently low, the first oscillator is blocked and the output of N2 is 'low'. This blocks the second oscillator, so that no tone is produced. If, however, the temperature rises above a certain point, the resistance of the NTC drops sufficiently far to enable the first multivibrator, sounding the alarm. The temperature at which this happens can be set with P1.

The repetition frequency of the alarm depends on the resistance of the NTC. As the temperature rises further, the repetition frequency increases. The more urgent the alarm sounds, the higher the temperature!

Needless to say, the NTC must be mounted inside the freezer. It can be connected to the rest of the circuit via thin, insulated wires.

Flood warning

The circuit for the flood warmer (figure 2) is very similar to the previous one. As before, gates N1 and N2 produce a low frequency square wave which switches

Figure 1. The deep-freeze alarm. The temperature sensor is an NTC, which must be mounted inside the deep-freeze.

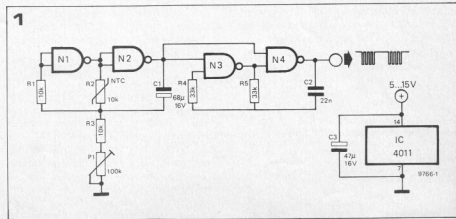

5

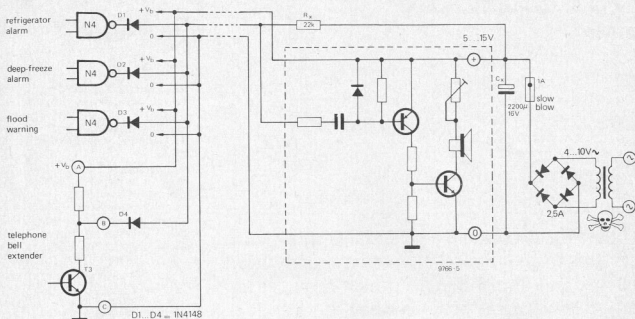

The DEW line

The interconnection of all alarm sensors described and the receiver is shown in figure 5. To avoid cluttering this diagram, only the last gate (N4) is shown of the refrigerator alarm, deep-freeze alarm and flood warning and only the last transistor (T3) of the telephone bell extender.

As can be seen in this diagram, one core of the (three-core) alarm cable is used for the positive supply connection and one for supply common. The third core is the signal line.

All the sensors have been designed to give a high-level output signal under normal conditions. This means that they can all be connected to the alarm line through diodes, as shown — the 'quiescent' sensors will not prevent an active alarm from sounding.

The receiver is connected directly to the line, as shown. As stated earlier, more than one receiver can be used; each receiver is connected to the line at the point required. There is one point to watch, however. If the 'volume' control in the receiver (the 100 Ω preset) is turned up to maximum, the peak current consumption can be more than 1 Amp. For this reason, it is advisable to give each receiver its own power supply. R_X should only be incorporated in one of the receivers.

While on the subject of the power supply, it is important to note that electrical safety is even more important than usual in this case. The alarm line will be running all over the house, and some of the sensors will be in a moist environment (the bathroom, for instance). For this reason, the mains transformer must be absolutely reliable, and the wiring inside the supply must also be such that there is absolutely no

Figure 5. The DEW line. Utmost care must be taken when constructing the power supply, so that there is absolutely no possibility of mains voltage appearing on the alarm cable.

chance of a short or even leakage between the mains and the rest of the circuit.

If the sensors described here are to be connected into the 'Wireless bell extender' circuit, they are interconnected with diodes as shown in figure 5. Instead of being connected into the receiver circuit, however, they are connected to point 'B' in the transmitter. ■

pocketronics



Anybody who regularly looks inside modern factory-produced equipment, and particularly radio and TV front-ends, will often be astounded by the number of components per square inch of printed circuit board.

On Elektor p.c. boards, we do try to keep the component layout fairly compact — but some fairly large components are used in most circuits. Furthermore, resistors and capacitors are all mounted flat on the board, since mounting them 'on end' requires rather more skill and care.

However, we felt that many of our readers might like to try their hand at mounting interesting little circuits in the smallest possible space.

The first idea was to start a series 'electronics in a nutshell', but this was soon dropped as definitely too ambitious.

The next suggestion was 'matchbox circuits'. Several circuits have indeed been developed that can be squeezed into a large-sized matchbox. Examples are the egg-timer and cricket elsewhere in this issue.

Even this title was found to hamper our stride, however: some interesting projects had to be housed in a cigarette carton. Finally, we settled for the all-embracing title 'pocketronics'.

To be able to fit the units into such a cramped space, the boards have all been designed for

truly miniature components. This may have the disadvantage that some of them are not so readily available:

- Resistors should be 1/8 watt types.
- Depending on the value, capacitors are usually miniature ceramic, Siemens MKM, tantalum electrolytic or miniature electrolytic.
- Transistors and ICs are usually standard types, but extensive use is made of the Darlingtons transistors BC516 and BC517 (Texas Instruments).
- Batteries are usually 1.2V miniature mercury types, as used in hearing aids, photographic equipment and the like.
- The 'loudspeaker', if required, is actually a dynamic microphone capsule (Sennheiser type HM35). Other types may also be suitable; the requirements are: very small dimensions, relatively high impedance (more than 500 Ω), and, preferably, relatively high efficiency.
- Standard potentiometers are not used. Where these would normally be needed, presets are mounted on the board. Some mechanical ingenuity, of the bent-wire type, may be required to replace the 'control knob'.

CALENDAR

R. ter Mijtelen



A circuit for producing a calendar display using the pulses from a digital clock has already been described in *Elektor 8*. This design provides an alternative circuit which gives day, date and month display, plus flashing display facility to draw attention to dates of particular interest.

The calendar is advanced by the 24 hr (i.e. midnight) pulses from a digital clock. Each pulse steps the date and the day displays by one. To facilitate the initial setting of the display, a higher frequency signal must be provided. The most suitable and convenient is the seconds pulse train from the clock. Logic is included in the circuit to enable the month display to change on the appropriate date. The only manual intervention necessary is the setting of a switch to indicate 'leap year' when necessary.

The date indication is by a pair of 7-segment units, while the day and month are displayed on illuminated windows in a suitably divided rectangular mask. A suggested lay-out for the front panel is shown in figure 5.

Day of the week display

Figure 1 gives the circuit diagram for the day display. The input is normally from the once-per-day 24 hr clock pulse, but it may be switched to the once-per-second pulse, by S1, when required. In either case the input signal

is fed, via a decoupling capacitor, to the input of the counter IC2 (7493) where the negative-going edge triggers the count.

The output of IC2, three bit BCD, is routed to the inputs of IC1 (7445). The count is automatically reset to zero when the value seven (BCD '1,1,1') is reached.

The values 0-6 of the count correspond to the days Monday - Sunday respectively. The BCD-decimal decoder chip IC1 takes the binary input and produces 10 outputs which can drive 80 mA loads.

Setting the day display to the correct value is achieved by feeding seconds pulses to IC2 (via S1).

The seconds pulses are also used in this circuit to provide a flashing display to draw attention to dates of interest. These one second pulses are gated by the flash enable input (connection 6). When they are passed by N1 to the fourth (D) input pin of IC1, the output is periodically inhibited. The selected lamp will then flash once a second.

Date display

The date display circuit is shown in figure 2. It consists of two counters constructed from flip-flops. A decimal counter is formed by FF1, FF2 (7476) and FF3, FF4 (7473), while FF5, FF6 (7473) form a divide-by-four counter. The operation of the decimal counter is best explained by considering the events which occur when the tenth input pulse arrives. This pulse must reset the counter to zero. The tenth pulse causes the Q outputs of both FF2 and FF4 to be high, so the output of NAND gate N33 goes to 0. This signal resets FF1 (i.e. the Q output goes to 0) and is inverted before being used (via N2) to reset FF2, FF3 and FF4. The falling edge of the Q output of FF4 increases the count of the divide-by-four circuit. The units of the date display (M1) are supplied by IC3, a BCD-to-7 segment decoder (7447), which uses the output of the decimal counter as its input. The tens of the date (M2) are supplied by IC4 (another BCD-to-7 segment decoder) using the output of the divide-by-four counter.

The monthly resetting of both counters is achieved by gates N18-N22. After this reset, the date must be 'one' not 'zero', therefore the decimal counter states A,B,C,D must be at 1,0,0,0 for the units, and the divide-by-four counter must be 0,0 for the tens. The operation is as follows:

in the normal state, the outputs of N19-N22 are all high, so that the output of N18 is low. The outputs of N25 and N26 are therefore high and have no effect on FF1, FF5 and FF6.

Similarly, the reset signal to FF2, FF3 and FF4 is high (provided no clear signal comes from N33 as already described). If one of the inputs 28, 29, 30 or 31 goes to logic 1, then the output of the corresponding NAND gate goes to 0, provided that the other inputs

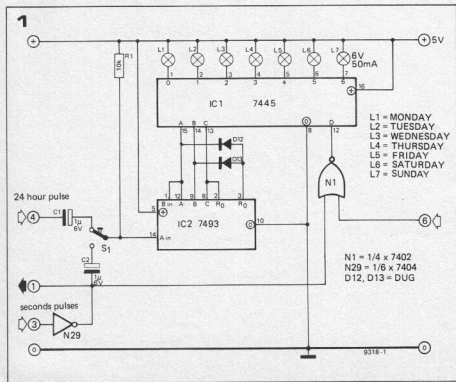

2

FF1...FF2 = IC 5 = 7476
 FF3...FF4 = IC 6 = 7473
 FF5...FF6 = IC 7 = 7473
 N2 = 1/4 x 7402
 N25...N27 = 1/2 7404
 N18...N22, N33 = 3 x 7420

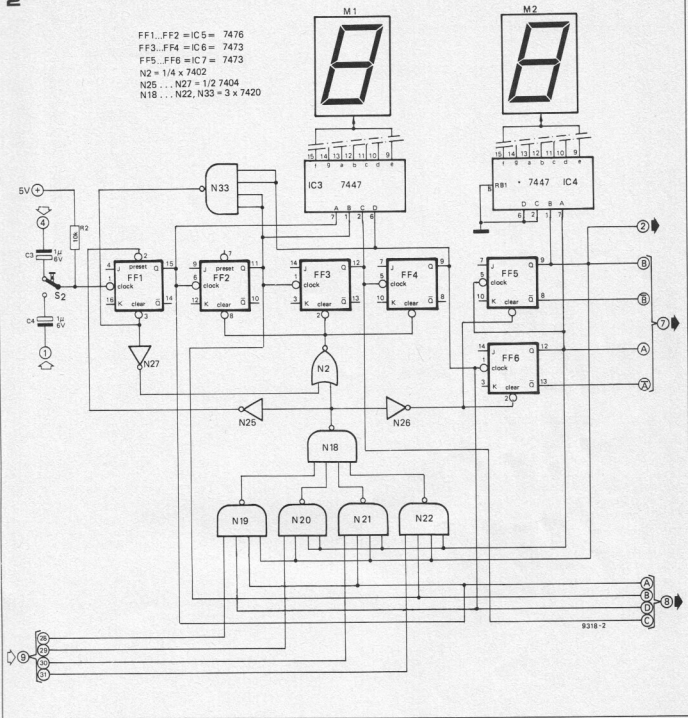

Figure 1. Circuit diagram for the day display. Each of the seven lamps corresponds to a day of the week.

Figure 2. Circuit diagram for the date display, which consists of two 7-segment numbers.

(taken from the two counters) are also 1. Connection 9 (inputs 28 to 31) is taken from the month display circuit and indicates the number of days in the month at present being displayed.

As an example: the date count is at 28 and the input pin 28 is high. The next incoming pulse sets the counters to 29 (i.e. the divide-by-four counter has the value 2, and the decimal counter has 9). All the inputs to gate N19 are therefore at logic 1, so the output is 0. The output of N18 goes to 1 causing FF2-FF6 to be reset, and FF1 to be set, so giving the desired output of 1 for the first of the month. The leading zero is suppressed by earthing the R_B input of IC4. This improves the legibility of single digit numbers.

Initial setting of the date is achieved by

feeding second pulses to the circuit by means of switch S2.

Month display

The month display (figure 4) is the same in principle as the day display, except that there are twelve lights instead of seven. As the decoder IC8 (7445) only has ten outputs available, two NAND gates (N30 and N31) are used for the other two. The output state of these gates is low for the values 10 and 11 from the counter, corresponding to the months November and December, respectively. These gates drive the lamps L18 and L19.

Resetting to zero, i.e. January, occurs at the thirteenth input pulse, which causes the counter to go to the value twelve, momentarily. This resets the

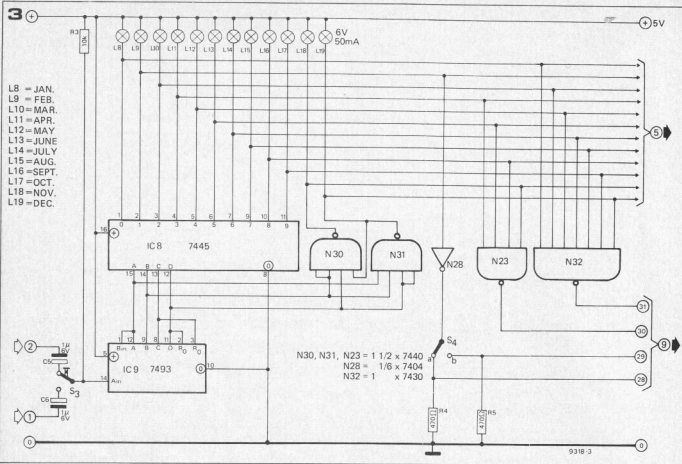

counter to zero because of the connections from D to R_{01} and C to R_{02} . The input to IC9 is normally supplied from FF5 (see figure 2) via connection 2. However, switch S3 is used for setting. Automatic resetting of the displays requires a further item of information, i.e. whether the month has 28, 29, 30 or 31 days. This information is coded by the inverter N28 and the NAND gates N23 and N32. If, for example, L9 is lit, then either lead 28 (for a 'normal year') or lead 29 (for a 'leap year') is at logic 1, depending on the position of switch S4. Inputs to the NAND gates are, however, all high, so the leads 30 and 31 are both low. Each light, when lit, produces the correct output at connection 9. Only the item 'leap year' needs to be fed in manually.

Date reminder

Figure 4 shows the circuit of the date reminder, which enables the day display for certain selected dates to flash, as explained earlier. This facility is an optional extra to the calendar, included for those who have difficulty remembering such things as your nearest and dearest's birthday.

The memory consists of a diode matrix, the NOR gates N3A...N13, the decoder IC10 (7442) and the NAND gates N14...N17. IC10 decodes the units of the date and the gates N14...N17 decode the tens. Eleven of the twelve month inputs are always high, with only the month at present being displayed providing a low input. Every date gives a unique output.

For example, consider the coding for February 16th:

IC10 : the sixth output is low (pin 7) and so the input to gates N4C, N8A and N11B are also low.

N14...N17: the output of N16 is zero, and also therefore, the second input to N8A.

Input 5 : 'February' is at zero, so the third input to N8A is taken to zero via diode D1.

The output of N8A is therefore at logic 1 which provides the flash enable signal at output 6, and the day display will now flash (see text: day display). As an example, the memory is shown with several diodes (D1...D11) connected, each one of which corresponds to one date in the year.

Figure 3. Circuit diagram for the month display, which is the same in principle as the day display circuit, but of course, twelve outputs are required.

Figure 4. The programmable memory for important dates. As an example, several dates have been programmed by means of the diodes shown.

Figure 5. A suitable front panel for the calendar. A red sheet of Perspex over the whole front gives good legibility and a pleasing appearance.

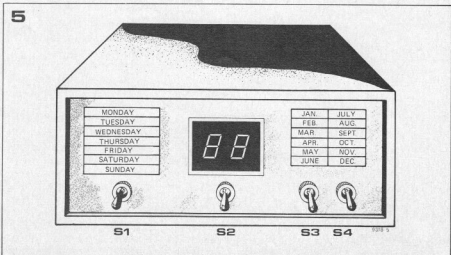

INTERCOM



A domestic intercom doesn't require a complicated circuit. The unit described here uses only a handful of components, even though an automatic gain control has been incorporated in the circuit.

This intercom was designed to meet two requirements: low cost and high performance.

To keep the cost down, the output stage is nothing more than a two-transistor class-A stage that can deliver 100 mW. To maintain good intelligibility in spite of this low power output stage, an automatic gain control is incorporated. This ensures that the output stage will nearly always be fully driven. To keep the cost of this gain control down, an OTA is used as the preamplifier — its gain is a function of a DC bias current. Small 150 Ω loudspeakers are used both as microphone and as loudspeaker.

The circuit

Switch S1 is the master 'press-to-talk'

button. When this switch is depressed, the loudspeaker in the main station (the upper loudspeaker in the diagram) is connected to the input of the amplifier. When the button is released, the other loudspeaker is connected.

Resistors R2 . . . R4 and capacitor C1 produce a smoothed DC bias voltage for the OTA. R5 and C4 are included in the input circuit to reduce clicks during switch-over from 'talk' to 'listen'; they also reduce the effect of interference pulses picked up by the (long) leads from the substation.

The output signal from the OTA is fed to the 'power' output stage T2 and T3. This stage only gives a voltage gain of a factor 2; its primary function is current gain, to drive the loudspeaker. S1 is

wired in such way that the output is fed to the loudspeaker that is not being used as microphone at that moment. Understandably . . .

The automatic gain control is derived from T1 with its associated components. This transistor is connected as a current source. The maximum current it can supply to the bias input of the OTA (pin 5) is

$$\frac{0.6 \text{ V}}{470 \Omega} = 1.2 \text{ mA.}$$

This corresponds to a maximum gain of the OTA of 2500 x. When the output voltage rises above a certain level, current starts to flow through D3. This raises the base voltage of T1 towards the supply level, thereby reducing the current through T1. This in turn reduces the gain of the OTA. This automatic gain control action is 'tamed' by including C5.

Installation

In most cases, the wiring to the sub-

Parts list

Resistors:

R1 = 47 k
R2 = 22 k
R3, R4, R6 = 10 k
R5, R10 = 1k2
R7 = 10 M
R8 = 470 Ω
R9 = 33 Ω
R11 = 1 M
R12, R13 = 2M2
R14, R15 = 1 k

Capacitors:

C1, C3 = 100 μ/16 V
C2, C5 = 10 μ/16 V
C4 = 100 n
C6 = 2μ/16 V
C7 = 100 μ/25 V

Semiconductors:

IC1 = CA3080
T1 = BC557B, BC177B, 2N1711
T2 = BC517 (darlington)
T3 = BC160, BC161, 2N3553
D1 . . . D3 = DUS, 1N4148

Sundries:

Cooling fin for T3
2 loudspeakers, 150 Ω/1 Watt
Switch or pushbutton, 2P2T

power supply:

Trafo 12 . . . 15 volt, 100 mA
Fuse 100 mA slow blow (and fuse holder)
Bridge rectifier B40C400
1000 μ, 25 V elco

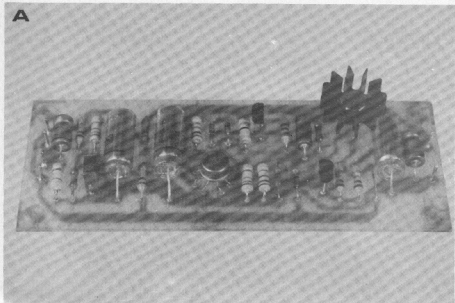

station can be normal two-core cable. However, if the distance is too great or if the leads run close to mains wiring it may be necessary to use single-core screened cable.

Since the output stage is running in class-A, the current consumption is too high for battery operation. It would be possible to use batteries if an on/off switch is included in the main station, but this would mean that the substation cannot initiate the conversation. For

SIGNAL HORN



Although designed as a warning horn for use with the 'Albar' ultrasonic alarm system described elsewhere in this issue, the signal horn may of course be used with any system requiring an audible warning. The parts outlay is small but the sound produced is loud and extremely penetrating.

It was decided at the outset that to keep the cost down the output transducer should be a cheap loudspeaker such as might be cannibalised from an old TV set, radiogram or other equipment. In view of the limited power handling capacity of such speakers it was decided that the best drive waveform would be a rectangular waveform with a low duty-cycle. In this way a high peak sound level could be obtained whilst staying within the average power rating of the speaker. This short duty-cycle also keeps down the current consumption of the circuit.

The circuit

The basis of the circuit is an astable multivibrator using the ubiquitous 555 timer.

With the control input (R1) open-circuit the output of the 555 switches T1 on and off, as is T2. When the input is grounded the circuit begins to oscillate at a frequency of about 400 Hz (determined by R3, P1 and C4). The duty-cycle of the waveform T is given by

$$T = \frac{P_1 + R_2}{R_3 + 2(P_1 + R_2)}$$

The duty-cycle may be varied between about 1% and 10% by means of P1. Since P1 is part of the frequency determining network this will also cause the frequency to vary slightly.

The output of the 555 switches T1 on and off, which in turn switches T2. In order to ensure fast rise and fall times at the output, the base resistors of T1 and T2 are kept small. The loudspeaker is connected in series with the collector of T2, and diodes D1 and D2 protect T2 against the back e.m.f. from the speaker.

The supply voltage to T1 and the multivibrator should not exceed 12 V, but the supply to the loudspeaker may be up to 60 V (with an 8 Ω loudspeaker) to obtain a louder signal. Alternatively, if the entire circuit is to be run from a single 12 V supply (e.g. a car battery) then several speakers may be connected in parallel (minimum 1 Ω paralleled resistance) to obtain a louder signal.

Construction

A p.c. board and component layout for the signal horn are given in figure 2. T1 should be provided with a clip-on heatsink for cooling. T2 may or may not require a heatsink depending on the number of loudspeakers driven and the supply voltage, but plenty of space is reserved on the board for the 'multi-finger' type heatsink.

Operating Hints

To make the maximum amount of noise, the loudspeaker should be mounted in a box made of a suitably resonant material (e.g. a biscuit tin). If the unit is intended for mounting outside then the enclosure should be watertight and the loudspeaker cone should be waterproofed with a few coats of

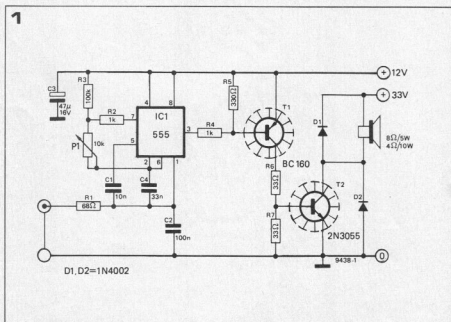

Figure 1. Circuit diagram of the signal horn. The duty-cycle may be adjusted by means of P1.

Figure 2. Printed circuit board and component layout. Note the cooling clip on T1 and the heatsink on which T2 is mounted.

Figure 3. An automatic interrupter for the signal horn, which may be required in some areas to comply with local regulations.

model aircraft dope or something similar.

Before mounting the signal horn on the outside of a building it is advisable to check the local laws concerning the use of alarms. In some areas continuous operation of an alarm may be prohibited and only intermittent operation is permitted.

Figure 3 shows the circuit of an automatic interrupter consisting of a 1 Hz astable multivibrator and a switching transistor. When point B is grounded the multivibrator will switch the horn on and off at one second intervals. This circuit may satisfy local regulations, and in addition the on-off switching of the alarm is more likely to attract attention.

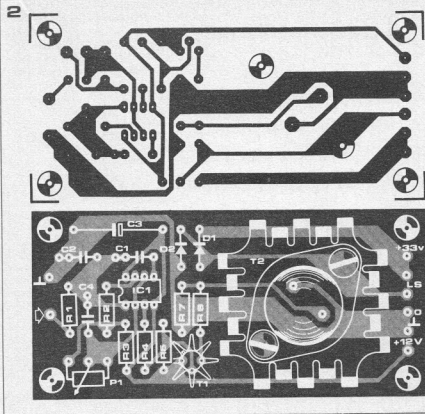

Parts list for figure 1:

Resistors:

R1 = 68 Ω
 R2, R4 = 1 k
 R3 = 100 k
 R5 = 330 Ω
 R6, R7 = 33 Ω
 R8 = 10 k

Capacitors:

C1 = 10 n
 C2 = 100 n
 C3 = 47 μ/16 V
 C4 = 33 n

Semiconductors:

T1 = BC180, BD132, BD140, MPS U51
 T2 = 2N3055
 D1, D2 = 1N4002
 IC1 = 555

3

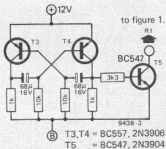

T3, T4 = BC557, 2N3906
 T5 = BC547, 2N3904

voltage-to-time converter

The well-known TTL IC type 74121 is a monostable multivibrator that can be set to give an output pulse with a duration of anything between 40 ns and 40 s. This pulse duration is determined by a single external RC combination. If the fixed resistor in the basic circuit is replaced by a variable resistor (i.e. a potentiometer), the length of the output pulse can be varied over a wide range.

In the circuit shown here, this principle is used to obtain a monostable multivibrator with a pulse duration that is determined by an external (DC) voltage. The original fixed resistor, which would have been connected between pin 11 and the positive supply, has been replaced by transistor T1. Resistor R1 is

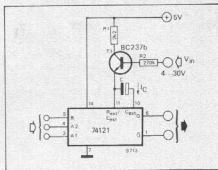

included to protect the IC from inadvertent overdrive.

The transistor works as a sort of variable resistor (with a 'resistance' that depends on the DC voltage applied to its base) and it determines the charging current flowing into the external capacitor C. The duration of the output pulse (t) is now set by the input voltage V_{in} , approximately as follows:

$$t \approx 0.7C \times (5 - V_{tr}) \times \frac{R_2}{\alpha' \cdot (V_{in} - V_{tr} - 0.7)}$$

where

t = duration of the output pulse (seconds)

C = value of capacitor C (Farads)

R_2 = value of resistor R_2 (Ohms)

V_{tr} = trigger voltage (typ. 3 V)

V_{in} = input voltage (volts)

α' = DC current gain of the transistor.

The monostable is triggered in the normal way, via the A1, A2 and/or B inputs.

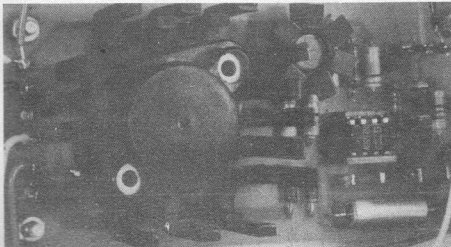

2

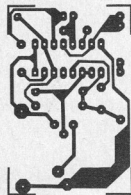
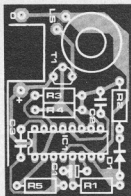
**Parts list:****Resistors:**

R1 = 470 k

R2 = 15 k

R3 = 820 k

R4 = 100 k

R5 = 560 k

Capacitors:C1 = 22 μ /6.3 V (tantalum)

C2 = 1 n

C3 = 22 n

Semiconductors:

T1 = TUN

N1 ... N6 = CD4049

D1 = DUS

Sundries:

Dynamic microphone, e.g. Sennheiser

HM35

3 miniature 1.2 V batteries, as used in

hearing aids

S1 = switch, SPST

third multivibrator (N1/N2) switches the chirping on and off periodically, thus determining the rest periods.

The square-wave output from N5 is fed to buffer-stage T1. This transistor drives the 'loudspeaker', which is actually a high-impedance dynamic microphone. The Sennheiser type HM35 is a good (and cheap — sorry, cheap) choice, but many other types will also do quite well.

The current consumption is very low, so the miniature mercury batteries should have a very long life. Open-heart surgery to replace the batteries should be required only very infrequently.

A printed circuit board for the circuit is available (figure 2), which should guarantee rapid reproduction of the creatures.

Figure 2. Printed circuit board and component layout.



FILM SLAVE

R.L.A. Trost

The film slave is a sound activated switch originally intended to control a cine camera. However, with little or no modification it may also be used for a variety of other purposes, such as automatic starting of a tape recorder in response to sound.

The film slave is intended for use with cine cameras or tape recorders that have a remote control jack (socket), or which can be modified to take one. The jack is connected in series with the motor supply of the camera, typically 3-9 V. In normal operation the internal contacts of the jack are closed and the camera is controlled by the manual button. However, when a plug is inserted into the jack the supply is interrupted and the camera may be controlled by a shorting switch connected across the plug terminals. With the shorting switch open the

supply voltage of course appears across the switch terminals and a few milliamps may be taken from it without causing the camera motor to run. This is made use of in the film slave, the circuit being supplied from the camera whilst the camera is stopped, and being supplied from its own internal battery whilst the camera is running. In this way the life of the film slave's battery is extended.

The circuit

The circuit (figure 1) comprises three sections, an input amplifier and pulse shaper, a bistable multivibrator (flip-flop) and output switching circuits. Sound is picked up by a crystal microphone and the resulting electrical signal is fed via C1 to IC1, which is connected as a non-inverting amplifier whose gain may be varied between about 7 and 320 by P1. Since the circuit is operated from a single supply voltage instead of the normal \pm supply used by the IC, the non-inverting input is biased to half-supply voltage by R1 and R2. C2 and C3 cause the gain of the amplifier to roll off below about 200 Hz so that pickup of mains hum and other low-frequency interference is not a problem. This arrangement may seem slightly unusual, but is necessary in view of the supply voltage fluctuations that occur when the circuit switches from the camera supply to its own internal battery. If a single capacitor to ground were used then charging currents flowing into it when the supply switched would upset the biasing. The split arrangement of C2 and C3 obviates this. The output of IC1 is rectified by D1 and is used to turn on T1, which provides the trigger pulse for the flip-flop T2/T3. Any loud transient sound such as a handclap will cause T1 to turn on momentarily. This will take the trigger inputs of the flip-flop (C8 and C9) low, and the flip-flop will change state.

Figure 1. Complete circuit of the film slave. When the camera is running the film slave obtains its supply from the camera via the remote control jack connected to points A and B. When the camera is started by a handclap, A and B are shorted out and the camera starts. The film slave then receives its power from an internal battery via T5.

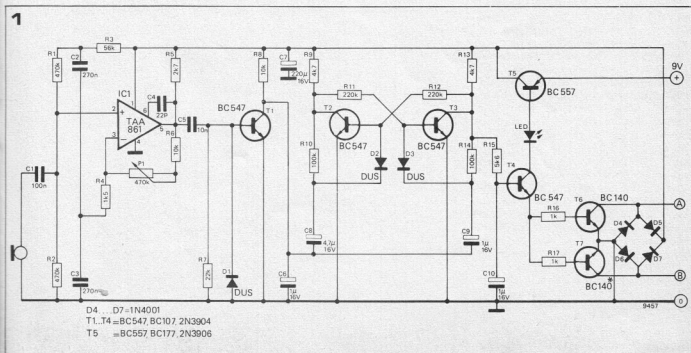

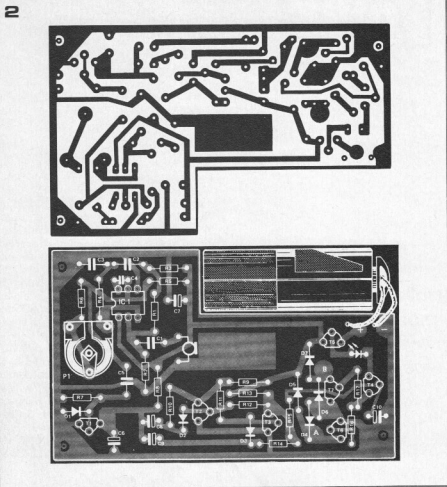

The flip-flop is symmetrical apart from the trigger capacitors. C8 is much larger than C9 so that when power is initially applied to the circuit the flip-flop will always be reset with T3 turned on and T2 turned off. In this initial state T4 will be turned off, as will T5, T6 and T7. The film slave will receive its supply from the camera via the diode bridge D4 to D7. This ensures that the supply voltage will always have the correct polarity irrespective of the polarity of the voltage from the camera.

When the flip-flop is triggered (set) by the sound signal T2 will turn on and T3 will turn off. T4 will be turned on, turning on also T5, T6 and T7. T6 and T7 short out points A and B, and again polarity is unimportant. If B is more positive than A current will flow through T7 and D5, but if A is more positive than B current will flow through T6 and D6.

The supply voltage to the film slave from the camera is now lost, but the circuit operates on its own internal battery, which is now switched in via T5. R15 and C10 slow down the switching of T4 so that the supply transition is less abrupt to prevent spurious triggering of the flip-flop. Reservoir capacitor C7 also helps prevent this. Shorting out of the film slave battery by T6 and T7 is prevented by the fact that D5 and D7 are reverse-biased. The LED in the collector circuit of T4 indicates that the camera is running.

The camera may be stopped by a second sound signal which will reset the flip-

flop, turning off T4 to T7. The circuit then reverts to operation from the camera power supply. A bonus with the automatic supply switching is that the film slave does not require an on-off switch.

After the completion of filming all that is necessary is to disconnect the film slave from the camera and (if necessary) reset it to the off state (LED extinguished) by tapping the box. The

Figure 2. Printed circuit board and component layout for the film slave.

Figures 3 and 4. Photographs of the completed film slave.

Figure 5. Modification to allow switching of any equipment by the film slave.

internal supply is now switched off and the external supply is disconnected so the circuit cannot respond to any further sounds until it is reconnected to the camera.

Construction

A printed circuit board and component layout for the film slave are given in figure 2, whilst figures 3 and 4 show views of the completed unit in its box.

5a

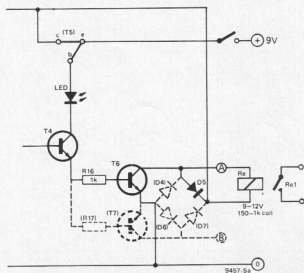

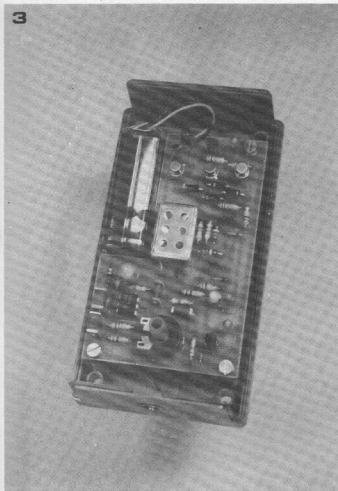

It must be stressed that the microphone used must be a crystal type, not a ceramic type which may have insufficient output for the circuit to operate satisfactorily. Apart from this point there is nothing unusual about the construction except to note that P1 should be accessible through a hole in the box so that the sensitivity may easily be adjusted to suit particular conditions of use.

Applications and Modifications

The circuit can, in principle, be used with any cine camera or tape recorder where remote control is effected by switching the motor supply voltage, which may be between 3 and 9 volts (DC or AC!) If, however, the remote control operates by switching the control voltage to an electronic motor speed regulator, then it is unlikely that the

film slave can be powered from the remote control jack. This may also be the case where the equipment to be controlled is other than a cine camera or tape recorder, so that the current and/or voltage to be switched is more than the circuit can handle.

In this case the general solution is to use the circuit of figure 5a. T5 and T7 are omitted, as are D4, D6 and D7. The base, emitter and collector connections of T5 on the p.c. board are interlinked so that the circuit runs from its own internal battery all the time, and T6 is used to switch a relay whose contacts control the equipment. In this case the film slave does require an on-off switch. If only very low currents are to be switched the relay may not be required, so that the circuit of figure 5b can be used.

5b

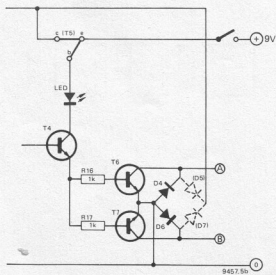

pulse generator

E. van Dee and B. Alberts

A pulse generator is an extremely useful aid when testing and servicing logic circuits. The generator described here is uncomplicated and is based on TTL IC's, but the facilities provided are quite comprehensive.

A pulse generator is considerably more complex than a simple squarewave oscillator. The facilities offered vary widely, but basically the pulse repetition frequency and pulse length are independently variable. In addition a pulse generator usually has a 'prepulse' output, which is a short needle pulse that appears before the main pulse. This may be used to trigger an oscilloscope before the main pulse so that the leading edge of the main pulse can be observed.

Principle of operation

The functions of the pulse generator can be explained by reference to the block diagram of figure 1. The whole circuit is driven by the clock generator G, which runs at four times

the pulse repetition frequency f_0 . The duty-cycle of the clock generator is not 50%, so the output is divided down by two cascaded flip-flops to give 50% duty-cycle squarewaves at $2f_0$ and f_0 . These outputs are available externally. The clock generator may be gated on and off by a signal at the Gate input, so that bursts of pulses may be obtained if required.

The trailing edge of the f_0 output triggers a one-shot, which introduces a delay before the main pulse appears. This delay can be varied by altering the one-shot time constants. When the first one-shot resets, its Q output triggers a second one-shot that produces the main pulse. The length of the pulse may be varied by altering the one-shot time constants. The outputs of the second one-shot are buffered by an output

Brief specification

Pulse repetition frequency	: f_0 1 Hz - 1 MHz in 7 decade ranges with fine control
Pulse length	: 10 ms - 100 ns in 5 decade ranges with fine control
Pulse delay	: 10 ms - 100 ns in 5 decade ranges with fine control
Rise time of outputs	: 10 ns
Clock outputs	: f_0 - 0.1 Hz - 1 MHz 50% duty cycle $2f_0$ - 0.2 Hz - 2 MHz 50% duty cycle
Width of prepulse signal	: 100 ns
Output impedance	: 50 Ω - short-circuit proof
Amplitude of all outputs, unloaded	: 5 V

stage and normal (positive-going) and inverted (negative-going) pulses are available at the outputs.

When the first monostable is triggered its Q output is differentiated to give a short spike — the prepulse output. The value of the prepulse output is obvious when one considers that no electronic circuit is free of delay. If the leading edge of the main pulse were used to trigger an oscilloscope timebase then all or part of this leading edge would be invisible due to delays in the oscilloscope trigger and timebase circuits — it would simply have finished before the timebase started to run. With the prepulse this does not happen since the timebase can be triggered before the main pulse begins.

In addition to continuous triggering by the clock generator, the pulse generator

1

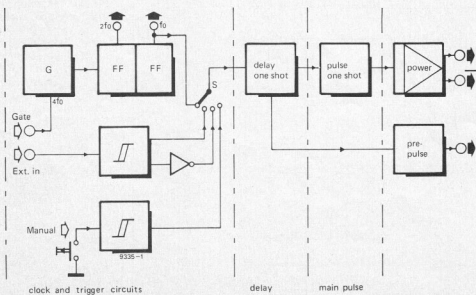
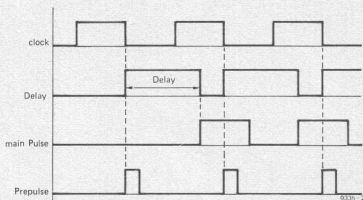

Figure 1. Block diagram of the pulse generator showing the three main sections.

Figure 2. Timing diagram for pulse generator operating on the internal clock, showing clock, delay, output and prepulse waveforms. Both one-shots are triggered on the trailing edge of the triggering signal.

Figure 3. Complete circuit of the pulse generator and power supply.

2



3

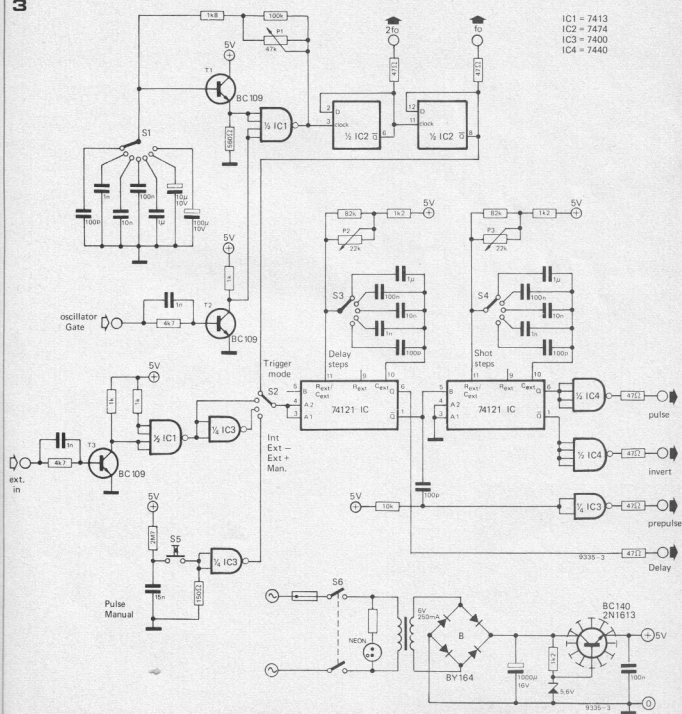

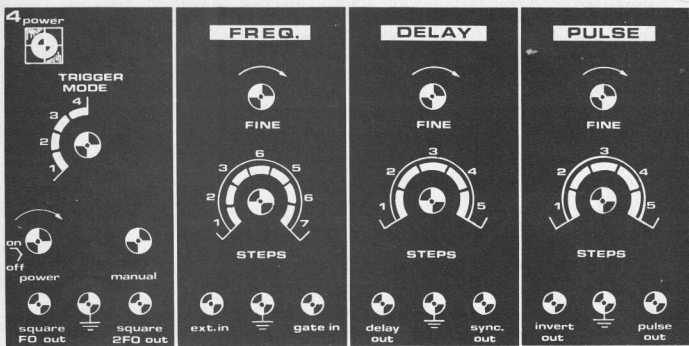

Figure 4. Suggested layout for the pulse generator front panel.

may also be triggered either repetitively or in a one-shot mode by an external signal — either positive or negative going. Triggering may also be accomplished by a manual pushbutton. These different triggering modes are selected by switch S. A timing diagram showing operation in the clocked mode is given in figure 2.

Complete circuit

Clock

Figure 3 shows the complete circuit diagram of the pulse generator, including the power supply. The clock generator consists of a Schmitt trigger, $\frac{1}{2}$ IC1, connected as an astable multivibrator. Coarse frequency selection is by means of S1, which selects the timing capacitor, while fine control is by means of P1. Emitter follower T1 increases the input impedance of the Schmitt trigger so that fairly small value time capacitors may be used without leakage into the IC input becoming a problem. The oscil-

lator may be turned off by applying a positive voltage to the Gate input, thus turning on T2.

The output of the clock is divided down by flip-flops IC2 go give outputs $2f_0$ and f_0 . The Q output of the second flip-flop is connected to one of the positions of S2 and thence to the A inputs of the delay one-shot. The Q output of the delay one-shot is connected to the B input of the main pulse one-shot. Both one-shots are equipped with range selection switches S3 and S4 and with fine controls P2 and P3. The pulse outputs are buffered by power NAND gates IC4.

Prepulse

The prepulse output is obtained by differentiating the Q output of the delay one-shot with a 10k resistor and 100p capacitor. This pulse is then squared up and buffered by a NAND gate.

Trigger modes

The external trigger input may be used with S2 in the second position by feeding positive pulses into the trigger

input, when the pulse generator will be triggered on the trailing edge of the pulse. With S2 in the third position the circuit will trigger on the leading edge of the pulse. With S2 in the fourth position the circuit may be triggered manually by means of S5. With S5 open the 15 nF capacitor is charged up to +5 V while the input of the NAND gate is held low by a 150 Ω resistor. Pressing S5 momentarily takes the NAND gate input high and the output goes low, triggering the delay one-shot.

Power supply

The power supply is very simple and consists of a mains transformer, bridge rectifier, reservoir capacitor and transistor and zener stabilizer. It should be noted that this supply has no short-circuit protection. If a short-circuit proof supply is required then an IC regulator such as the L129 or LM309 may be substituted for the transistor, resistor and zener. Current consumption of the circuit is about 100 mA. A suggested front panel layout for the pulse generator is shown in figure 4.

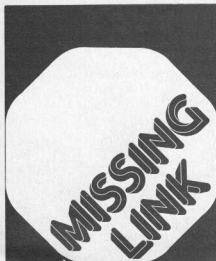

Three channel mixer

Summer circuits (E15/16), no. 48, page 735:

Resistors R3, R6, R9, and R15 should be 220 k. Delete the junction between P5/R4 and R3/R6/R9/R15/⊕; P5 should only connect to R4.

coming soon:

phasing/vibrato

SANTATRONICS

white/pink noise generator

REFRIGERATOR ALARM



This unit will sound the alarm if the door of a refrigerator is left open too long. Very few components are required for this effective food-and-energy-saver. It can be used either as a self-contained unit or as part of the 'Domestic alarm' described elsewhere in this issue.

The fact that the door of the refrigerator has been left open is sensed by an NTC, which is mounted as close to the bottom of the door as possible. When the door is left open, cold air pours over this sensor. As the temperature of the NTC drops its resistance rises and at a certain point this causes a multivibrator to start oscillating at a very low frequency.

After a certain delay time has elapsed, this starts a second multivibrator. The (intermittent) output of this second multivib is amplified to produce a sufficiently loud alarm signal.

The delay period before the alarm goes off is set so that normal opening and closing of the door will not trigger an alarm signal.

The circuit

The unit consists of two basic parts: the alarm circuit proper and the 'power' amplifier.

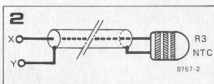

Figure 1. Complete circuit of the refrigerator alarm. The NTC is connected between points X and Y, by means of a screened cable as shown. It should be mounted just below the lower edge of the door.

Figure 2. The NTC is connected between points X and Y, using screened cable as shown.

The alarm circuit uses a single IC, containing four CMOS NAND gates. Gates N1 and N2 are used in the low frequency multivib which sets the repetition rate of the alarm signal; gates N2 and N3 produce the actual alarm tone. As the temperature of the NTC (R3) drops, its resistance rises. At a certain point this starts multivib N1/N2. The temperature at which this point is reached can be set with P1.

The output of N2 drives N3, which is part of the second multivib. At the same time, it starts to charge C3 through the delay network R6, D1/R7, C2, R8 and P2. After an interval (set with P2) C3 will have charged sufficiently to 'free' N4, the other gate in the second multivib. This multivib will now oscillate during the positive cycles of the first multivib, so it will produce a series of alarm tones. Obviously, the initial delay should be set with P2 so that normal use of the refrigerator doesn't trigger the alarm.

The 'power' amplifier consists of a simple two-transistor output stage. Since it is driven by a square-wave with a relatively low duty-cycle, the dissipation is quite low. Transistor T2 should be chosen according to the supply voltage used, as shown in the table. P3 is used for setting the volume according to taste.

Final note

This alarm circuit can easily be used as part of the domestic alarm ('DEW line'). The units have been designed with this in mind.

It must be possible to distinguish between the various alarm units when they are all run together as part of the domestic alarm system. For this reason, the pulse repetition rates and the actual alarm frequencies have all been set so that they are completely different from one another. It should not be difficult to hear the difference.

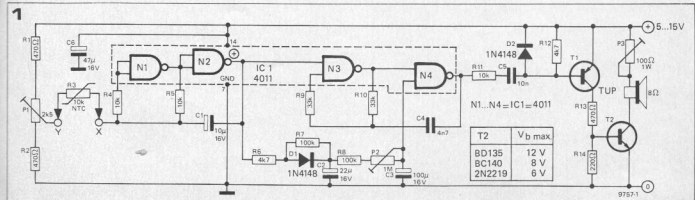

CAPACITOCOUPLING



A number of methods are known to permit isolation between separate but otherwise co-operating electric circuits. Perhaps the most familiar example is the ordinary transformer. A more recent development in this field is the optocoupler, but other systems using either magnetic or electrostatic coupling are also possible.

In this article an electrostatic system is described which can be used as part of a sophisticated light dimmer.

The magnetic coupling method has the disadvantage that it is difficult for the home constructor to make a neat job of the necessary transducers. Optocouplers have been used for various tasks in previous Elektor articles. The remaining approach, electrostatic coupling, can be accomplished very easily by etching a capacitive coupler on the printed circuit board. A design based on this approach is given here.

Circuit operation

Gates N2 and N3 form an oscillator

which is enabled, or 'gated', when pin 5 is at logic level one (1). Since N1 is an inverter, pins 1 and 2 must be at a low logic level to enable the oscillator. If it is assumed that the 'enable' signal which is applied to pins 1 and 2 has a square wave shape, the gated oscillator will produce a burst of pulses during the time the input waveform is low.

The isolation between the transmitter and receiver section of the circuit is effected by two small capacitors C_{X1} and C_{X2} . These capacitors are etched on the p.c. board.

N5 is biased to function as a normal amplifier, and when used in combination with the next amplifying stage (N6), it regenerates the burst being transmitted across the isolation capacitors. This burst is then detected by an envelope detector made up of components D1, R6 and C4. The output signal from gate N7 will now correspond to the original 'enable' signal.

This detected signal is differentiated by C5/D2/R7. It is also passed through inverter N8 and differentiated by C6/D3/R8. The pulses that result from both positive and negative differentiation are used to trigger the triac.

Triacs capable of currents up to about 1 A can be mounted on the printed circuit board. Others with higher current ratings must be 'out boarded' and will most likely need heat sinks.

The coupling capacitors

As stated earlier, the coupling capacitors can be etched on a p.c. board. An obvious choice would be a double-sided board, with one 'plate' etched on each side. However, since two-sided p.c.b.'s are expensive and hard to make at home, capacitors C_{X1} and C_{X2} are formed by using two separate boards. It is important to note that the two boards must be joined together in such a way that only one thickness of the fiberglass board is in between the copper areas that form the plates of the capacitors. If the plates are two board thickness apart, the resultant capacity will be too low and the circuit will not function properly. Also, the daughter board should be fitted directly against the mother board, with no gaps in between.

Tap sensor control

The circuit shown in figure 2 can be used as the interface between the triac controller shown in figure 1 and the 'outside world'.

The tap sensors control a set/reset flipflop constructed from two C-MOS NAND gates and a few resistors.

To prevent this FF from assuming an indeterminate state when the power is switched on, the FF is preset to the off state by C1. This can be particularly useful in areas where power cuts are frequent...

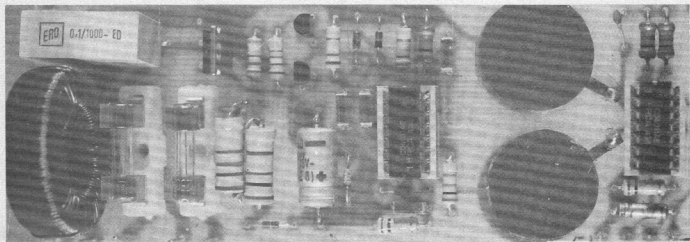

3a

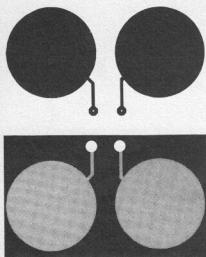

Figure 3. Printed circuit board and component layout for the triac control circuit. Note: large copper areas are C_{X1} and C_{X2} . (EPS 9516).

Figure 4. Tap sensor p.c. board and component layout (EPS 9707).

Parts list for figure 2

resistors:

R1, R3, R6 = 10 M
 R2, R4, R7 = 1 M
 R5, R10 = 12 k
 R8 = 22 k
 R9 = 1 k
 P1 = 47 k (preset)
 P2 = 100 k (lin.)

Capacitors:

C1 = 22 p
 C2 = 680 n
 C3, C4 = 100 n
 C5 = 100 μ /16 V

semiconductors:

D1 = 12 V/400 mW zener
 D2 ... D8 = 1N4148
 IC1 = CD4011

3b

Parts list for figure 1

resistors:

R1, R6 = 100 k
 R2, R3, R5 = 10 k
 R4 = 1 M
 R7, R8 = 220 k
 R9, R10 = 120 Ω
 R11 = 8k2
 R12 = 180 Ω

capacitors:

C1 = 1 μ 5/16 V
 C2 = 100 p
 C3, C5, C6 = 1 n
 C4 = 12 n
 C7 = 100 μ /16 V
 C8 = 100 n/1000 V (ceramic)

semiconductors:

T1, T2 = BC547, 2N3904
 IC1, IC2 = CD4011
 D1 ... D3 = 1N4148
 D4 = 1N4004
 Tri = 600 V, with adequate current rating.

misc:

noise suppression coil: 2.5 mH, with adequate current rating.
 Z1 = fuse, 25 mA
 Z2 = fuse, depends on load.

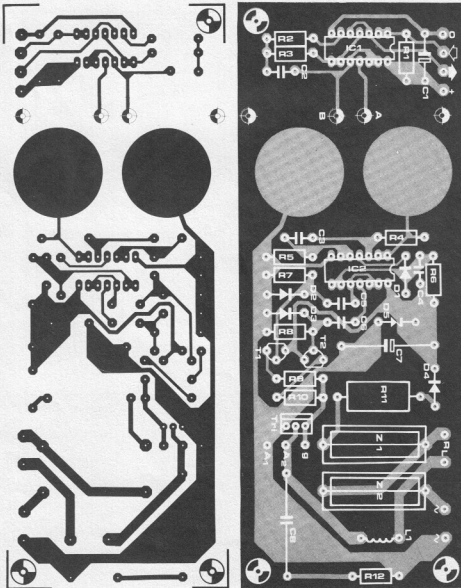

4

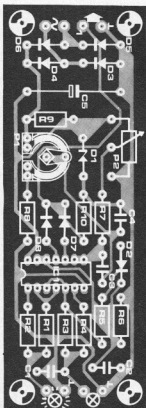
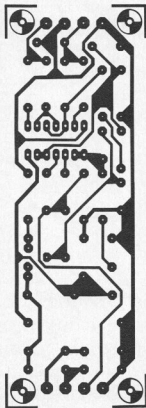

reading-in-bed limiter



At a certain age, children are often packed off to bed with the final admonition: 'All right, you can read in bed for a quarter of an hour, but then you must turn off the light and go to sleep'. However, as most parents will know, the children tend to suddenly lose all sense of time in this situation . . .

When a member of the Elektor design team was faced with this problem, he started looking for an electronic solution. The final circuit, as published here, has proved extremely effective.

In the situation outlined above, what is really required is a unit that will automatically turn off the bedside reading lamp after the specified time has elapsed. This time switch must have a few special features:

- It should only be possible for the parent(s) to switch on the lamp. This

Figure 1. Complete circuit of the reading-in-bed limiter. S1 must be a key-switch that can only be operated by the parents.

1

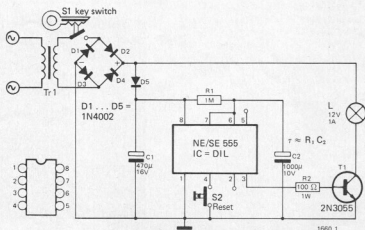

1660 1

can be achieved by using a key switch.

- It should be possible for the child to turn off the lamp before the allotted time has elapsed, if it finds that it is getting too sleepy to read. Since the child hasn't got the key to the main switch, a further reset button is required.
- For safety reasons, it is essential to use a low-voltage lamp. The whole circuit, including the lamp, should be run off a reliable mains transformer. Since they are easy to obtain, a logical choice is to use a 12 V lamp as used in cars.

The circuit

The obvious choice for the timer itself is the 555 timer IC, since this can be set to give delay times up to several hours with complete reliability. Furthermore, the obvious transistor type to use for switching the lamp is the well-known 'work-horse' the 2N3055. Having chosen these two components, the circuit design is almost finished! The complete circuit is shown in figure 1.

The IC is used as a monostable multivibrator (MMV). The duration of the output pulse is set by a single RC-network, R1 and C2. In this particular application, the pulse duration is practically equal to the RC time. If R1 is 1 M and C2 is 1000 μ , as shown, the RC time is 1000 seconds, or just over a

quarter of an hour. Note that any leakage in C2 will extend this time appreciably; for this reason it is advisable to use a tantalum electrolytic, and not to increase the value of R1 any further.

Initially, C2 is discharged. When the circuit is switched on via the key-switch S1, C2 starts to charge through R1. During this time, the output of the IC (pin 3) is at positive supply level. This turns on transistor T1, lighting the lamp. R2 limits the base current to the transistor. With the type of lamp shown (12 V, 10 ... 15 W), the dissipation in T1 should be so low that a heat sink is not required. The supply to the lamp is the raw, full-wave rectified supply voltage. There is nothing to be gained by smoothing this supply.

An extra diode (D5) and a relatively small smoothing capacitor (C1) are used for the supply to the IC.

When the RC-time has elapsed, the output of the IC switches to 0 V, turning off T1 and the lamp. Pushing the reset button (S2) will switch the lamp off sooner. Since the 'set' input (pin 2) is not used, the only way to switch the lamp on again is to first turn the supply off, wait until C2 has discharged, and then switch on again. Officially, this should be done with the key-switch. It is not advisable to demonstrate even once that the same effect can be produced by pulling out the mains plug for

a short time ...

A printed circuit board layout for the unit is shown in figure 2.

Note that sufficient care should be taken with the mains connection. Use good cable, a rubber grommet where the cable enters the box, and some form of clamp over the cable just inside the box so that there is no 'pull' on the connection to the transformer.

Figure 2. Printed circuit board and component layout for the unit. T1 can be mounted on the board, since a heat-sink should not be necessary (EPS 1660).

2

Parts list:

Resistors:

R1 = 1 M
R2 = 100 Ω

Semiconductors:

IC = 555
T1 = 2N3055
D1 ... D5 = 1N4001, BY126, etc.

Capacitors:

C1 = 470 μ /16 V
C2 = 1000 μ /10 V

Sundries:

S1 = key switch
S2 = reset push button
L = 12 V/1 A lamp
Tr1 = transformer, 12 V/1 A

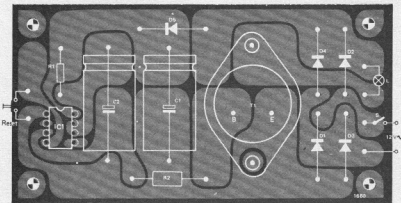
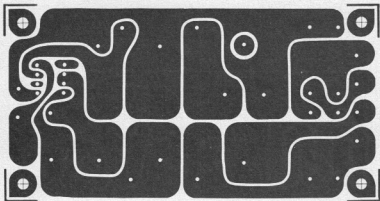

a LOGICaI replacement for the carbon-track potentiometer (or TAP out the music!)

Ever since the onset of this Electronic Age, the zippy electron has been steadily taking over from the cumbersome mechanical and electro-mechanical equipment in a wide variety of applications. Signalling and other data transmission systems, calculators and business machines, clocks and watches, for instance, are obvious examples.

A firm last stand, however, seems to have been made by the familiar carbon-track potentiometer. Despite its inherent deficiencies such as inaccuracy and short useful life it has retained its popularity, particularly in the field of entertainment equipment, because it is cheap, easy to use for all kinds of controls in electronic circuits and is often easily replaceable.

The trend now is to limit the use of these devices which have a habit of becoming noisy in their old age, and in advanced circuitry they have been largely replaced by controls such as varicaps, variable-slope transistors, biased diodes and other electronic devices. This article proposes further relegation in that the control voltages for a circuit are not even derived remotely from carbon-track pots, but from logic which produces the voltages entirely electronically, from finger-tip touch sensors.

A convenient circuit to consider converting is the 730-740 stereo control amplifier published in the December 1975 Elektor. In this design, volume, balance and tone are all DC voltage controlled from conventional potentiometers. At first sight, the requirements for generating control voltages electronically would seem to indicate complicated circuitry, but this does not turn out to be the case.

First consider the properties of the electro-mechanical potential divider. A wiper contact can be moved along a carbon track (by the operator) to produce an output voltage which is proportional to the distance of the wiper along the track. The output voltage remains the same while the wiper is stationary. An electronic equivalent must, therefore, have two properties: A) an output voltage must be produced which varies continuously in accordance with some external command; B) the output voltage must remain constant in the absence of a command, i.e. it must be stored.

Now consider applying these requirements to the 730-740 amplifier. The control voltages in question can vary between 1.0 and 9.0 V and are used for gain, balance, bass and treble adjustment. The electronic generation of these voltages does not present a serious problem; one solution would be to charge or discharge a capacitor via a constant current source. Storing the magnitude of this control voltage is, however, another kettle of fish.

Long-term electronic analogue memories based on circuits with extremely long time constants do exist, but their cost is prohibitive for this type of application. An approximation to non-volatile analogue storage could be made by loading a capacitor with a high impedance device (such as an MOS-FET), whereby the capacitor could be made to retain its charge for quite some time, up to, say, a couple of hours. In practice, though, we have found that such a circuit is far from reliable, and is difficult to construct. At this point, as with so many analogue problems, a solution is offered by using digital techniques. The following actions provide an elegant and simple solution:

- (1) convert the analogue information into a suitable digital form;
- (2) store this digital information in a memory;
- (3) retrieve this digital information and convert it back into an analogue signal.

A major advantage of this procedure is immediately evident: digital information is very easy to store and a number of devices that can do the job are readily available.

By using TTL ICs, the initial outlay, maintenance and constructional complications are all reduced.

The problem has now been reduced to that of A/D conversion, step one from above. This is achieved by taking an instantaneous sample of the varying analogue quantity, measuring the sample

against some standard and expressing the result as a digital (usually binary) number. In this design, A/D conversion is achieved as follows: an analogue input causes a flip-flop register to count either up or down until the desired control voltage (produced by D/A conversion) is achieved, at which point the input is removed so the counting stops and the register retains its digital value until a new sample (i.e. further input) is received. The desired control voltage has been reached when the listener detects correct stereo balance, for instance. Since, by definition, digital measurements are made in discrete steps, the accuracy of the A/D conversion depends on the number of steps available over a given range of values, i.e. the smaller the size of each step, the better the accuracy of the A/D conversion and the greater the amount of information retained. The number of available steps may, therefore, be said to determine the 'resolution' of the system. This circuit uses four-bit flip-flop registers, so that sixteen steps are available for quantifying each analogue signal.

Block diagram

The block diagram in figure 1 shows that the four functions (gain, balance, bass and treble) are controlled by four almost identical circuits which are clocked by a common slow-rate pulse generator.

- Each functional unit marked 'A' in the diagram contains the following circuits:
- a four-bit pulse-controlled ('synchronised') counter;
 - a 'sampling' input circuit to convert the state of the sensors into count up/down instructions for the counter (A/D conversion);
 - an enable/inhibit circuit 'freezing' the counter in the absence of counting instructions;
 - a max./min. inhibit circuit to stop the counting when the register is either full or empty;
 - a D/A conversion output circuit which translates the state of the flip-flop register into a DC control signal.

As long as one of the touch sensors is activated, the appropriate output signal varies according to a 16-step staircase (up or down) a function, where each step coincides with a clock pulse.

Each unit marked 'C' in the diagram performs the following functions:

- smoothing the discontinuities of the step functions;
- amplifying the output signal (after D/A conversion) to the level required by the 730-740;
- serving as impedance matching and preventing feedback from the 730-740 into the logic circuitry.

The unit marked 'B' also performs all these functions, but in addition it provides a non-linear relationship between the D/A output and the input to the 730-740.

'A' in more Detail

Figure 2 shows the functional units of which the blocks 'A' in figure 1 are each

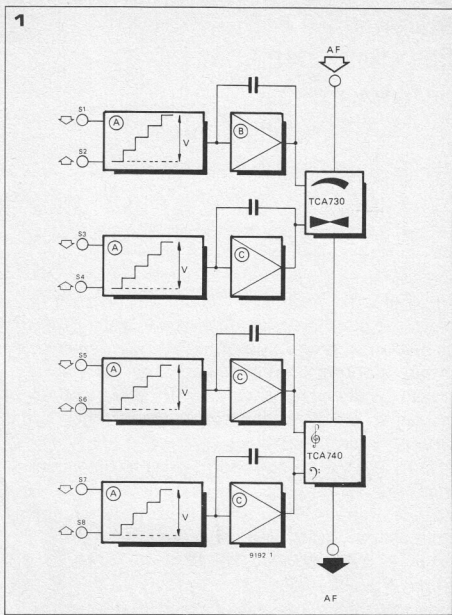

Table 1

Truth table (74191)

counter state	Q _A	Q _B	Q _C	Q _D
0	0	0	0	0
1	1	0	0	0
2	0	1	0	0
3	1	1	0	0
4	0	0	1	0
5	1	0	1	0
6	0	1	1	0
7	1	1	1	0
8	0	0	0	1
9	1	0	0	1
10	0	1	0	1
11	1	1	0	1
12	0	0	1	1
13	1	0	1	1
14	0	1	1	1
15	1	1	1	1

Figure 1. Block diagram showing the functional units necessary to convert the input from the TAP sensors into control voltages for the 730-740 stereo control amplifier.

Figure 2. Functions performed by each of the four 'A' blocks in figure 1.

Figure 4. Pin configuration of the 74191 counter.

comprised. The circuit 'A1' is common to all four blocks and generates (slow) clock pulses to synchronise the counters 'A3'.

Input is received from the two touch sensors. Note that the arrows shown next to the sensors refer to the direction of the command, such as 'increase volume' for the upward arrow and 'decrease volume' for the downward arrow. This is not the same as the counting direction performed by the flip-flops. The command 'increase', i.e. count down, is given by touching S2 (in figure 2) which causes it to become conductive. Touching S1 causes count upwards. The amount of the change in the control voltages to the 730-740 is proportional to the duration of the conductivity. With either sensor operating, an enable signal is produced for the counter, but if neither is being touched the enable is inhibited. This enable signal and the direction of counting are produced by the input circuit (A2).

The output of the counter is shown by the four flip-flop outputs, Q_A, Q_B, Q_C, Q_D. To convert this information into an analogue signal, the outputs are fed to an additive resistor network, A4, whose

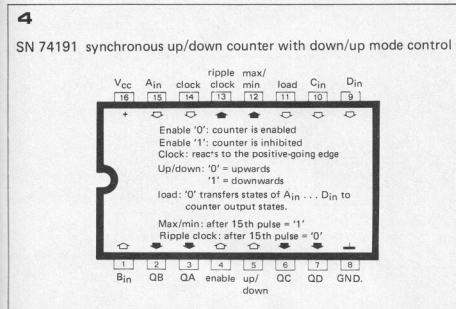
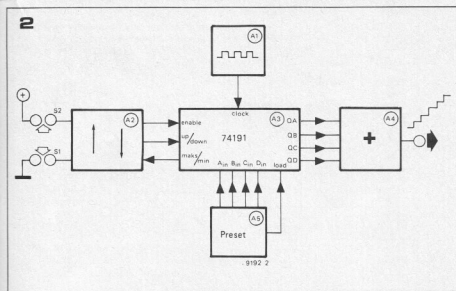

output is a staircase-type signal, as shown. As long as the counter is not enabled, and the power remains on, the state of the counters remains the same. The preset unit A5 provides reset values to the flipflops which are loaded immediately after switch-on. These presets are enabled by the 'load' signal which is a short duration pulse present only after power switch-on. The presets are selected so that reasonable levels of volume, balance, bass and treble are obtained when the equipment is first switched on.

The Circuit

The complete circuit diagram is given in figure 3. The heart of each of the functional groups is the counter (IC3, IC4, IC5, IC6), which is the standard TTL type 74191. Apart from the power supply (not shown here) the only common circuit is the clock pulse generator; two Schmitt triggers from a 7413 (IC8) with biasing produce a pulse train with a frequency of approximately 3 Hz. The pin connections for the 74191s are shown in figure 4. The four outputs, QA, QB, QC, QD, are available on pins 3, 2, 6, 7 respectively. The states of

the flip-flops during counting are given in table 1. At switch-on, the A, B and C flip-flops are reset to '0' and the D flip-flop to '1', so that the mid-range output is obtained (see table 1). The preset values are only available to the flip-flops while the 'load' signal (pin 11) remains at 0 V, i.e. until capacitor C10 becomes charged via the resistor R27. Counting takes place when the enable

signal (pin 4) is '0', and will be upwards if the level at pin 5 is '0' and downwards if it is '1'. Overflow or underflow, i.e. when the counter state reaches either 15 or 0, is indicated by a '1' on the max/min output pin 12.

Each of the four output control voltages is controlled by two TAP sensors, of which S1, S3, S5 and S7 cause a voltage decrease (the logic counts upwards), and S2, S4, S6 and S8 cause an increase. While the sensors are not operating, S1, S3, S5 and S7 are connected to the positive supply rail via 10 M resistors and S2, S4, S6 and S8 are similarly connected to the earth rail. The smoothing capacitors (C1 . . . C8) absorb any hum or spurious electrostatic induction. When a sensor is touched, the relatively low resistance of the skin causes the quiescent logic potential to invert. The output state of the sensors is fed to the input circuits (A2 in fig. 2), which operate as follows. Consider the circuit controlled by S1 and S2. In the non-operative state S1 is at logic '1' and S2 at '0' and the outputs of gates N1 and N2 are '0' and '1' respectively. With the max/min signal from IC3 at '0' (i.e. any condition other than overflow or underflow) transistor T1 is non-conducting since both its emitter and base are at zero potential.

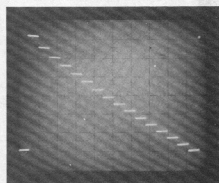

Transistor T2 is conducting, though, so that a '0' is present at the up/down input (pin 5) of IC3. Counting up does not occur, however, since the '1' at the collector of T1 inhibits the counter via pin 4. If S1 is now touched, the output of N1 changes and T1 conducts so that the signal on pin 4 becomes '0', thus enabling counting. If the overflow condition is reached, the max/min signal

Table 2

Sensor		Logic State of IC1				Control Signals	
S1	S2	8	12/13	9/11	10	enable*	up/down
0	0	1	0	1	0	1	0
0	1	0	0	1	1	0	0
1	0	1	1	0	1	0	1

* whenever the counter reaches either 15 or 0, the max/min signal is set to '1' and the enable signal becomes '1', regardless of the state of the sensors.

3

N1 ... N4 = IC1 = CD4011
 N5 ... N8 = IC2 = CD4011
 ST1...ST2 = IC8 = 7413

Figure 3. Complete circuit diagram of the logic which produces four voltages for controlling volume (gain), balance, bass and treble.

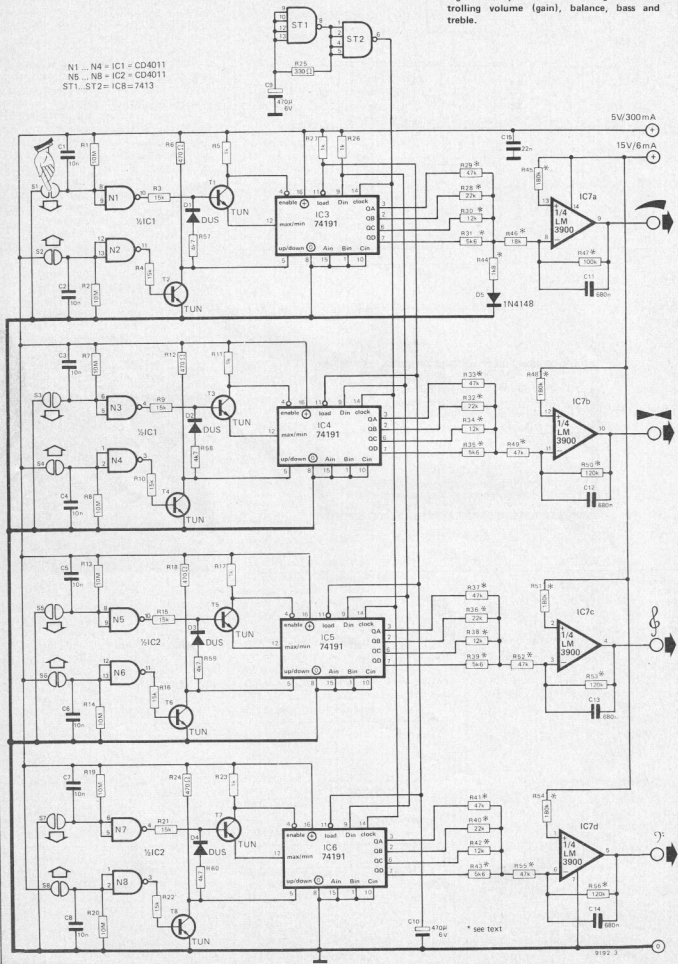

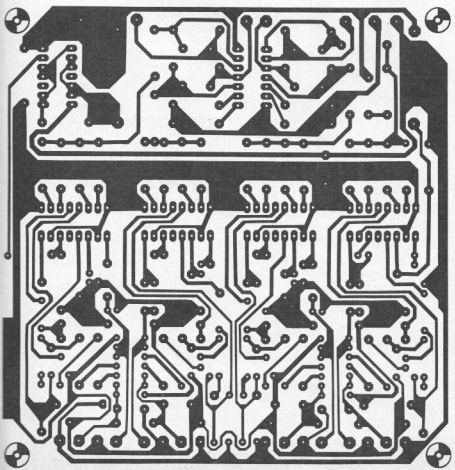
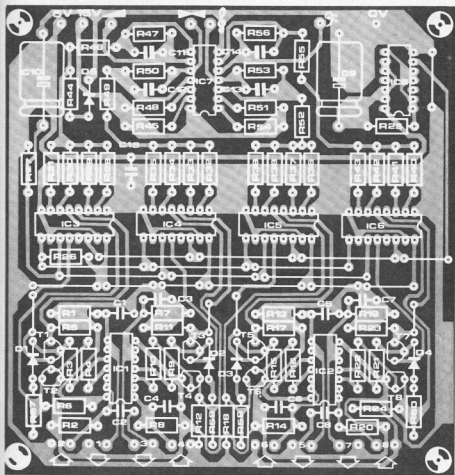

changes to '1' so T1 stops conducting. This results in the enable signal being removed so that further counting is inhibited.

If, on the other hand, S2 is touched, T2 stops conducting and the up/down signal therefore changes to '1' which resets the max/min signal on pin 12. Also, T1 is now conducting, so the enable signal to pin 4 is present. Counting will be downwards this time because pin 5 is at '1'. Underflow will cause T1 to stop conducting and so counting will again be inhibited.

The preset values for the counters (A5 in figure 2) have already been described, and are input on A_{in}, B_{in}, C_{in} and D_{in} pins.

The weighted resistors R28 . . . R43 convert the digital output from the counters into analogue 16-step staircase signals. If the resistors are 5% tolerance (or better) the steps will be sufficiently even.

At the lower counting limit (underflow) the resulting analogue level is approximately 0.2 V and at the upper limit approximately 3.3 V. The 730-740 requires control voltages in the range 1 V . . . 9 V so some conversion is necessary.

The active devices linking the D/A converter outputs to the 730-740 inputs are 'Norton' type DC amplifiers. Contrary to conventional opamps, the Norton types have differential current inputs, not voltage. For this reason they are most suited for a virtual earth input configuration, as shown in figure 5. Returning to figure 3, the opamp quiescent current is obtained from a reference current flowing through R45, R48, R51 or R54 into the non-inverting input. The 'current mirror' input circuit of the opamp reflects this reference current by feedback through the resistors R47, R50, R53 and R56. With the parameters chosen, the quiescent current supplied by the Norton amplifier causes a potential drop of approximately 10 V to develop across the feedback resistor. Figure 5 shows that the voltage gain of the circuit is determined by the ratio of the feedback resistance to the input resistance (on the inverting input).

The capacitors C11 . . . C14 smooth the staircase signals so that a more continuous rise or fall of the control voltage is obtained.

The three DC inverting amplifiers IC7b . . . IC7d which supply the balance, bass and treble controls, are identical. The relationship between the D/A converted voltage (at the junction of the resistor network) and the output of the current amplifier is linear, with each step of the staircase being approximately 0.2 V.

IC7a, which provides gain control, has a slightly different arrangement for quiescent current and gain settings, this is necessary to compensate for the non-linear drop in the TCA 730 control response. The compensation is achieved by R44 and D5 between the resistor network and earth. For low voltages the combination is non-conductive, but as

the voltage increases to more than about 0.7 V, the bypass D5 resistance gradually drops, reducing the staircase steps to approximately one third of the original 0.2 V amplitude. The inversion performed by the IC7a turns this negative departure from linearity into a positively incremental control gradient compensating for the negative bend in the TCA 730 control response.

Power Supply

The equipment needs 15 V and 5 V supplies, but the current demands are not very stringent. The 15 V line for the sensors supplies about 6 mA which can easily be derived from the existing supply for the 730-740. The 5 V supply should be stabilised, preferably by means of an integrated stabiliser such as the LM309 or L129. For this circuit the transformer secondary should supply about 8 V.

Constructional Notes

All the integrated circuits in this control equipment are conventional types from well-known manufacturers and should be readily available. Apart from these active components, the equipment uses eight transistors and five diodes, all of which appear in the TUP-TUN-DUG-DUS lists. The resistors marked with an asterisk in the diagram and parts list should have tolerances of 5% or better.

Parameter Selection

This unit's operational parameters were determined by the designer's likes and dislikes. Other users may wish to alter some of the settings such as clock frequency, counter presets or the time constants determining the response of the final amplifiers.

The clock frequency in the circuit shown is approximately 3 Hz, which means it takes about 5 seconds to count all the way up or down between 0 and 15. This count speed is determined by the value of C9, an increase in capacitance slowing down the counting process.

The presets can be changed simply by strapping the A_{in} . . . D_{in} connections to the power lines to give the desired state of the flip-flops (see table 1).

The time constants for the final amplifiers are determined by the capacitors C11 . . . C14. The constant chosen here is approximately 0.5 seconds, which gives reasonable smoothing of the stair-

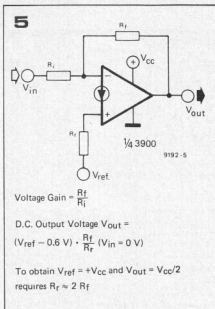

Parts list:

Resistors:

R1, R2, R7, R8, R13, R14, R19, R20 = 10 M
 R3, R4, R9, R10, R15, R16, R21, R22 = 15 k
 R5, R11, R17, R23, R26, R27 = 1 k
 R6, R12, R18, R24 = 470 Ω
 R25 = 330 Ω
 R28, R32, R36, R40 = 22 k**
 R29, R33, R37, R41, R49, R52, R55 = 47 k**
 R30, R34, R38, R42 = 12 k**
 R31, R35, R39, R43 = 5k6**
 R44 = 1k8**
 R45, R48, R51, R54 = 180 k**
 R46 = 18 k**
 R47 = 100 k**
 R50, R53, R56 = 120 k**
 R57, R58, R59, R60 = 4k7

Capacitors:

C1, C2, C3, C4, C5, C6, C7, C8 = 10 n
 C9, C10 = 470 μ /6 V
 C11, C12, C13, C14 = 680 n
 C15 = 22 n

Semiconductors:

IC1, IC2 = CD 4011
 IC3, IC4, IC5, IC6 = 74191
 IC7 = LM 3900
 IC8 = 7413
 T1, T2, T3, T4, T5, T6, T7, T8 = TUN
 D1, D2, D3, D4 = DUS
 D5 = 1N4148

** = 5% tolerance

case steps. The smoothing, however, introduces delay in the response time: after the sensor has been released the control voltage continues to change for a while. The settling time can be decreased by lowering the capacitances, but the steps will then be more distinct.

Preliminary Tests and Some Further Constructional Notes

After work on the printed circuit is finished and inspected, testing can begin, for which a DC (20 k Ω /V) multimeter is the only instrument required.

The first check is to make sure the counters come-up in the correct preset conditions. After applying the power to the unit, the counters should be in the preset condition, therefore the output voltages should be at a mid-range value, i.e. between 4 and 5 V. The next test is to determine that touching each sensor produces the predicted result. Any 'bugs' found at this point should not be too difficult to find. Logic levels for the digital circuitry can be checked with reference to table 2 (Logic '0' should be less than 0.8 V and '1' more than 2 V.). The counter outputs can be checked with the help of table 1.

Testing the clock pulse generator is even simpler: pulses at pin 6 of IC8 should cause the multimeter to deflect. Once the digital circuits have been verified, the only possible source of remaining faults is the final amplifiers. Check all the resistors and capacitors and if the unit is still faulty, replace the LM 3900. The only remaining problem is the mechanical construction of the TAP sensors. The most obvious design would be to use copper tracked p.c.b. sheets, but the snag with this is that condensation in the sensor gap remains conductive for some time after the sensor has been released; complete evaporation may take a number of minutes. A better design is one in which raised contacts are used, so that the deep gap provides sufficient insulation. Figure 6 shows such a commercially-made sensor, but, of course, such a design is beyond the scope of the average DIY amateur. As long as factory-made sensors or sensor fields are not stocked by retailers, the DIY man will have to rely on his own resources. A familiar sensor array is made from dome-headed screws, round-head furniture tacks or something similar. These are very simple to make: for each sensor mount two such tacks at 3/16 in spacing, the heads being the business ends, in a sheet of compressed insulating material or epoxy resin. The legs sticking through to the reverse of the sheet can be used as soldering pins. When using screws, the obvious connection is one using soldering tags, washers and nuts.

Although these and similar home-made sensor arrays do little to enhance the appearance of a front panel, their electrical performance is quite satisfactory. It is therefore left largely to the individual to arrive at an acceptable solution.

Figure 5. The LM 3900 used as a DC amplifier.

Figure 6. A factory-made touch sensor which is not generally available through retail outlets.

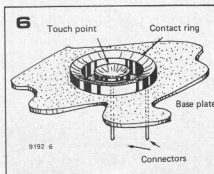

WHO and WHERE

A directory of electronic component suppliers to Elektor readers

IF THERE IS A COMPONENT SHOP IN YOUR AREA NOT LISTED BELOW PLEASE LET US KNOW



AREA 1

The Amateur Radio Shop

13, Chapel Hill,
Huddersfield, Yorkshire,
Tel. 20774

Bell's Television Services

190, Kings Road,
Harrogate, Yorkshire,
Tel. (0423) 55885

Derwent Radio

28 Hillcrest Avenue,
Scarborough, North Yorkshire,
Tel. 0723 63982

Suttons

50 Blue Boar Row,
Salisbury,
Tel. 27171

M & B Components Ltd

86 Bishop Gate Street,
Leeds 1 LS1 4BB,
Tel. 0532 35649

Greenbank Electronics

94 New Chester Road,
New Ferry, Wirral,
Merseyside L62 5AG,
Tel. 051-645 3391

AREA 2

Campbell Electronics Ltd

Tweedale Industrial Estate,
Telford, Salop TF7 4JR,
Tel. Telford (STD 0952)
585799,
Telegrams: CAEMLEC

Chas. H. Young Ltd

170-172 Corporation Street,
Birmingham B4 6UD,
Tel. 021-236 1635

G.F. Milward

369 Alum Rock Road,
Birmingham B8 3DR,
Tel. 021-327 2339

The Radio Shop

16 Cherry Lane,
Bristol BS1 3NG,
Tel. Bristol 421196,
S.T.D. Code 0272

Magtronics Ltd

Snarestone, Burton-on-Trent,
Staffs. DE12 7DB,
Mail order only.

AREA 3

Ambit International

25 High Street,
Brentwood, Essex,
Tel. (0277) 216029,
Telex: 995194

Arrow Electronics

Coptfold Road,
Brentwood, Essex,
Tel. 0227 219435

Amtron UK

4-7 Castle Street,
Hastings, Sussex TN34 3DY,
Tel. Hastings 437875

Basic Electronics Ltd

18 Epsom Road,
Cruikford, Surrey

B. Bamber Electronics

5 Station Road,
Littleport, Cambs. CB6 1QE,
Tel. ELY (0353) 860185

Bi-Pre-Pak Ltd

222-224 West Road,
Westcliff-on-Sea,
Essex SS0 9DE,
Tel. Southend-on-Sea 46344

Candis Limited

P.O. Box 25 Canterbury,
Kent,
Tel. Canterbury (0227) 52139

Cavern Electronics

94 Stratford Road,
Wolverton, Milton Keynes,
Tel. Milt. K. 314925

Charles Town

89 Carrington Street,
Nottingham,
Tel. Nottm. 868933 and 55489

Chromasonic Electronics

56, Fortis Green Road,
London N10 3HN,
Tel. 01-883 3705

Cliffpalm Ltd

13 Hazelbury Cres.,
Luton, Beds.,
Tel. 0582 415832

C.T.S. Ltd

20 Chatham St.,
Ramsgate, Kent CT11 7PP,
Tel. Thanet 54072

Custom Electronic Controls

45, Picardy Road,
Belvedere, Kent DA17 5QH,
Tel. Erith 34476

Direct Electronics

627 Romford Road,
Manor Park,
London E12 5AD,
Tel. 01-553 1174

Eley Electronics

100/104 Beatrice Road,
Leicester,
Tel. Leicester 871522

Electrovalue Ltd

28 St. Judes Road Road,
Englefield Green,
Egham, Surrey,
Tel. Egham 3603

Frank Mozer Ltd

5 Angel Corner Parade,
Edmonton, London N18,
Tel. 01-807 2784

GB Garland Bros. Ltd

Chesham House,
Deptford Broadway,
London SE8 4QN,
Tel. 01-692 4412

Harrington Colorvision

9 Queen Street,
Colchester, Essex,
Tel. Colchester 47503

HB Electronics

54 Montagu Street,
Kettering Northants,
Tel. (0536) 83922

H.G. Rapkin

22 Wellingborough Road,
Abington Square,
Northampton,
Tel. 37515

M.M. Electronics

Church Road,
Tunstead, Norwich,
Tel. 0603 614154

MTRS

20 White Hart Street,
Mansfield, Notts.,
Tel. Mansfield 23107

Maydale Electronic Services

2 Wellesley Parade,
Gudstone Road, Whyteleafe,
Surrey CR3 0BL,
Tel. Upper Warringham 5169

M. & B. Services

182a High Street,
Margate, Kent

Mays of Church Gate

12/14 Church Gate,
Leicester LE1 4AJ,
Tel. 58662

Orchard Electronics

Flint House, High Street,
Wallingford, Oxon OX10 0DE,
Tel. Wallingford (0491) 35529

Philcom Electronics Ltd

Electronic Centre,
45 Lower Hill Gate,
Stockport, Cheshire SK11 1JQ,
Tel. 061.480.9791

Phoenix Electronics (Solent) Limited

46 Osborne Road,
Southsea, Portsmouth, Hants.

R.S.M. Television

38 Carrington Street,
Nottingham,
Tel. Nottm. 868933

Sintel

53(K) Aston Street,
Oxford,
Tel. 0865 49791

Smiths of Edgware Road

287-289 Edgware Road,
London W2 1BE,
Tel. 01-723 5891

Stephens Electronics

Akeman St.,
Tring, Herts.,
Tel. 044282 3389

Swanley Electronics

P.O. Box 68
Swanley, Kent,
Tel. Swanley 64851

Technomatic Ltd

54 Sandhurst Road,
London NW9

QC Trading

1 St. Michaels Terrace,
Wood Green,
London N22 4S,
Tel. 01-889 7593

AREA 4

WM. B. Peat & Company Ltd

25/26 Parnell Street,
Dublin 1, Ireland,
Tel. 749973/4

The easy way to a PCB...

...the Seno 33 system!



The Dalo Pen!
The original fine-line etch resist marker. Simply draw the planned tracks onto the copper-clad board — new copper-Dri inks ready for Quick-Dri in minutes. Valve controlled ink dispensing for longer life. £1.50 for 1, £5.00 for 6, £9.40 for 12.

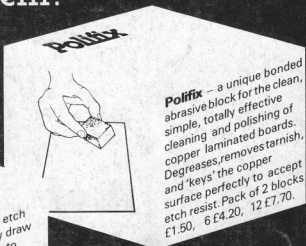

Polifix — a unique bonded abrasive block for the clean, simple, totally effective cleaning and polishing of copper laminated boards. Degreases, removes tarnish, and 'keys' the copper surface perfectly to accept etch resist. Pack of 2 blocks £1.50, 6 £4.20, 12 £7.70.

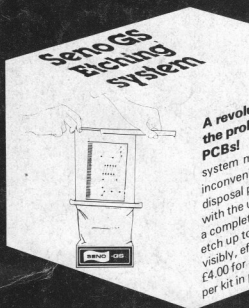

A revolutionary solution to the problems of etching PCBs! Unique sealed system minimises the risk, inconvenience, storage and disposal problems associated with the use of acid etchants — a complete kit designed to etch up to eight boards rapidly, visibly, effectively and SAFELY! £4.00 for a complete kit, £3.45 per kit in packs of 6.



Seno etch resist transfer symbols for a truly professional finish!

Sharply defined, adhesive-backed symbols in easy-to-use strip form, adhere direct to copper laminate and offer total etch resistance. Presented in packs of 10 strips, each of different symbol. £2.00 per pack, £17.50 per 10 packs.

Seno 33 — The Laboratory in a box

From your usual component supplier or direct from:

DECON LABORATORIES LTD.
Ellen Street, Portslade,
Brighton BN4 1EQ
Telephone: (0273) 414371
Telex: IDACON BRIGHTON 87443