

up-to-date electronics for lab and leisure

ELEKTOR 2

Swish Style

minidrum
displays
DIL-LED probe
big ben
tv sound
modulation systems
how to gyrate

February 1975 35p

contents

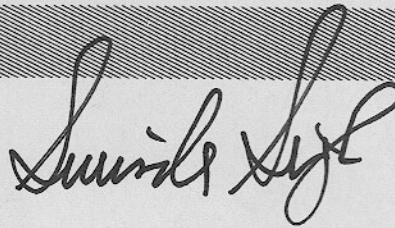

minidrum	208
Elektor laboratories have designed a new electronic instrument which shows great similarity to a real set of drums. In future issues new instruments and an automatic rhythm section will be described.	
sonant	215
philips sonant	216
In the article "sonant", elsewhere in this issue, a definition is given of a new type of "active" sound-reproducer design. A practical realisation of the sonant-principle is to be found in the recently presented Philips 22RH532 "Electronic". This article describes a few aspects of the way in which this sonant operates.	
motional feedback	220
improving readability of displays	221
microdrum	222
Linking up more or less with the minidrum published elsewhere in this issue of Elektor, this article describes the simplest member of the electronic drum family.	
universal display	223
Elektor laboratories have designed a universal display which should satisfy the requirements of most enthusiasts. The display may be used with seven-segment indicators of the LED or Minitron type.	
dil led probe	227
The probe discussed in this article is suitable for testing 14- and 16-pin dual-in-line ICs under operating conditions.	
the missing link	229
elektor "sonant" loudspeaker system	230
An earlier article explained the operating principle of the electronic loudspeaker. It was shown that this approach enables a woofer in a relatively small enclosure to provide really good reproduction quality from 40 Hz upwards. The second step is to describe a complete system, using active crossover networks, based upon the electronic loudspeaker used as a woofer.	
tv sound	234
For those who are dissatisfied with the quality of their television sound (and who isn't?) here is a design which enables a high-quality sound signal to be derived from a television receiver and fed into a separate amplifier and speaker system without making any connection to the T.V. set.	
three-eyed bandit	238
From time immemorial man has played games of chance. Modern technology has considerably widened the scope of games of chance so that a whole range of 'gaming machines' can be seen today.	
big ben 95	239
Nowadays both mechanical and electronic doorbells playing complete melodies are commercially available. The Big Ben plays a striking and well-known melody.	
cos/mos digital ic's	241
mos tap	242
Only recently has it become possible economically to replace the simple electromechanical switch by an electronic system with no moving parts - the Touch Activated Programmer (TAP).	
modulation systems	246
This article should give an insight into the various modulation systems now in use and will also explain the design philosophy of a new transceiver developed by Elektor.	
maxi display	251
recip-riaa	252
The performance of preamplifiers for magnetic pickup cartridges is invariably not sufficiently well known. The weighting network described in this article greatly simplifies measurement of the amplitude response (RIAA or IEC curve), overdrive margin, distortion, signal-to-noise ratio and hum level.	
how to gyrate - and why	255
The gyration principle was suggested by theoreticians over 25 years ago, although it is rarely seen in practical circuits. In this article the theoretical principles of the gyrator are discussed, and some practical circuits and applications are presented.	
improved 7 segment display	258
psychedelic lights	259

minidrum

The Elektor laboratories set out to design a new electronic instrument which would show great

similarity to a real set of drums. The success of this project was confirmed by a number of percussion players at a Hi-Fi exhibition in Amsterdam, where demonstrations of the Minidrum proved highly successful.

The great advantage offered by a conventional set of drums over an automatic rhythm generator is that the player produces all the rhythms himself, thus resulting in a more lively and varied sound. Of course, the novice percussion player will initially experience difficulties in producing different rhythms, but these will come with practice.

The three percussion instruments generally used in a basic drum kit are bassdrum, snaredrum and cymbal and the Minidrum consists of these three instruments. In future issues the system will be expanded to include several more instruments, a ruffle system and an automatic bassdrum for keeping time. Finally we shall publish a design for a fully automatic rhythm generator for those who want this facility.

Design of the Minidrum

The Minidrum is controlled by a touch activated programmer (TAP) instead of by mechanical pushbuttons, and comprises four boards (see figure 14) the TAP board, gyator boards for the bassdrum and snaredrum, a noise board for the cymbal and snaredrum and finally a mixer-preamplifier.

The TAP

The TAP circuit of figure 1 utilises an RCA COSMOS hex-inverter IC. This is available in two versions, the CD4009AE and the CD4049AE, the difference being that the 4009 has an extra supply connection to the output stage (pin 16). Production of the 4009 is shortly to cease as it has been found that this connection gives trouble in certain applications. Figure 1 shows the connection for the 4009, where a protection diode D_1 is connected between positive supply and pin 16. If the 4049 is used D_1 may be omitted as pin 1 only is the positive supply connection.

The operation of the TAP is very simple and since the three channels are identical the Bd channel only will be described (Bd, Sd and Cy stand for bassdrum, snaredrum and cymbal respectively). In

the quiescent state the input of I_1 is held high by R_1 . The output is thus low and C_1 is uncharged. If the Bd input contact is touched hum from the skin causes the output of I_1 to switch between '0' and '1' at 50 Hz (I_1 is actually operating as a very high input impedance, high gain amplifier). C_1 charges via D_2 and the voltage at the Bd_5 output is used to control the bassdrum. When the contact is released C_1 discharges via R_7 into the bassdrum circuitry in about 60mSec. R_7 is included to limit the current into the bassdrum circuit and thus to protect

both the bassdrum circuit and the output of I_1 .

The TAP p.c. board

The TAP p.c. board is shown in figure 2 and the associated component layout in figure 3. It can be seen that there is space for six TAP channels on this board, but only three of them are used in the basic Minidrum. The others will be used in the more sophisticated systems in future issues.

When constructing this board it is recommended that a socket is used for the

1

Components list to figures 1 and 3:

resistors:
 $R_1, R_2, R_3 = 27 \text{ M} \text{ or } 10 \text{ M}$
 $R_7, R_8, R_9 = 47 \text{ k}$

capacitors:
 $C_1, C_2, C_3 = 0,22 \mu$
 $C_7 = 100 \mu, 10 \text{ V}$

semi-conductors:
 IC = CD4009AE or CD4049AE (RCA)
 $D_1, D_2, D_3, D_4 = \text{DUS}$

Parts are coded in conformity with codes on the universal PC board designed for a maximum of six inputs and outputs.

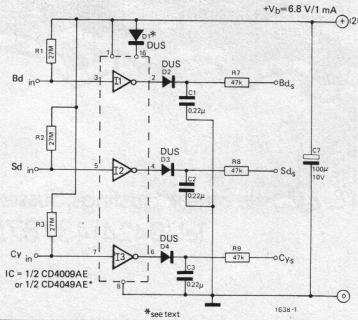

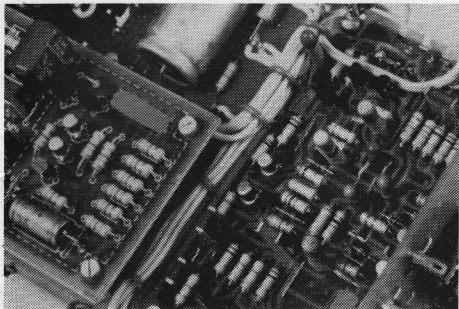

IC to avoid the possibility of damage due to static charges, leakage from 'unearthed soldering irons etc. The IC should be the last component mounted on the board. If the input leads from the touch contacts are longer than about 3 cm, then they should be screened with the screening connected (at one end only) to the supply common. The output leads need not be screened if they are shorter than about 6 cm.

Bassdrum and snaredrum gyration

The circuit diagram of the gyration which

produces the bassdrum and snaredrum sounds is given in figure 4. As the gyration may be an unfamiliar concept to some readers the theory is discussed elsewhere in this issue, but a few words of explanation will be given here. In essence, by using a gyration a capacitor may be made to simulate an inductor. Bulky conventional inductors may thus be eliminated in certain applications. In figure 4 C_6 is gyrated into an inductor and this simulated inductor appears across C_7 thus forming a parallel-resonant circuit which determines the frequency

of the instrument.

The gyration board has two control inputs, input 1 and input 2, each comprising a monostable and filter. Only one of these is shown in figure 4, however, as only one control input is used in the basic Minidrum. The monostable consisting of T_1 and T_2 receives the control signal from the TAP and produces a rectangular pulse. This is shaped by the filter consisting of C_3 , C_4 , C_5 , R_{10} and R_{11} to give the appropriate attack and decay characteristics for either the bassdrum or the snaredrum, depending on the component values. This shaped pulse is applied to the base of T_7 to control the gyration. Output P' is not used in the bassdrum, but in the snaredrum it is connected to the noise board. The output of the gyration if filtered by C_8 , C_9 and R_{23} .

The gyration board

The printed circuit for the gyration is given in figure 5 and the component layouts for the two versions are shown in figures 6a and 6b. Note the differences between the two boards where components are omitted in the snaredrum version and also the space for an additional monostable at the top left-hand corner of both boards.

The noise circuits

The conventional snaredrum, in addition to the basic tone, produces a characteristic 'tizz' caused by the catgut snares

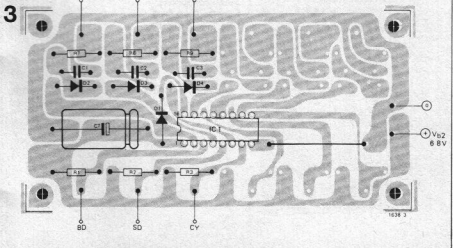
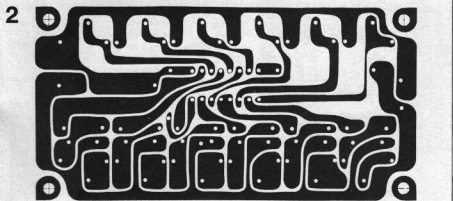

Figure 1. The circuit of the basic Minidrum TAP.

Figure 2. The TAP p.c. board which has provision for up to six TAP channels.

Figure 3. The component layout for the TAP as used in the basic Minidrum. As only three inputs are used the component codes do not all follow in numerical order since the board is coded for six channels.

Figure 4. The circuit of the gyrotor as used in the basic Minidrum for the bassdrum and snaredrum. The component values in brackets apply to the snaredrum, the others to the bassdrum.

Figure 5. The universal gyrotor p.c. board.

Figure 6a. Component layout of the bassdrum gyrotor. As can be seen the components relating to input 2 have been omitted.

Figure 6b. The component layout for the snaredrum gyrotor board. Again the components for input 2 have been omitted.

Figure 7. The noise circuitry for the snaredrum and cymbal. As can be seen from the diagram the cymbal is driven from a monostable on the board.

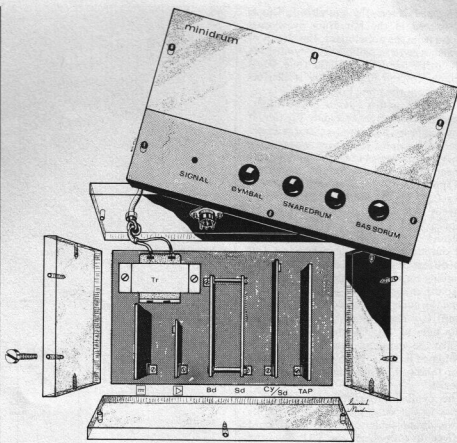

7

Components list to figures 7 and 8.

resistors:
 $R_{66}, R_{68}, R_{71}, R_{76} = 100 \text{ k}$
 $R_{67} = 2\text{M}7$
 $R_{58}, R_{60}, R_{61}, R_{69}, R_{70}, R_{75}, R_{97} = 10 \text{ k}$
 $R_{59} = 4\text{k}7$
 $R_{62}, R_{63}, R_{65}, R_{73}, R_{92} = 470 \text{ k}$
 $R_{64} = 820 \text{ k}$
 $R_{66}, R_{93} = 6\text{k}8$
 $R_{67} = 330 \text{ k}$
 $R_{67a}, R_{94a} = 10 \text{ M}$
 $R_{72}, R_{98} = 27 \text{ k}$
 $R_{74}, R_{77} = 270 \text{ k}$
 $R_{94} = 680 \text{ k}$
 $R_{95} = 120 \text{ k}$
 $R_{96} = 5\text{k}6$
 $P_2 = 10 \text{ k}$, preset

capacitors:
 $C_{16} = 100 \mu\text{F}, 10 \text{ V}$
 $C_{22} = 47 \text{ n}$
 $C_{23}, C_{28} = 4\text{n}7$
 $C_{24} = 150 \text{ n}$
 $C_{25} = 120 \text{ n}$
 $C_{26} = 12 \text{ n}$
 $C_{27} = 220 \text{ n}$
 $C_{30} = 100 \text{ p}$
 $C_{31}, C_{32} = 10 \text{ n}$
 $C_{39} = 8\text{n}2$
 $C_{40} = 22 \text{ n}$
 $C_{41}, C_{42} = 2\text{n}7$

semi-conductors:
 $T_{17}, T_{18}, T_{21}, T_{22}, T_{23}, T_{26} = \text{TUN}$
 $T_{19}, T_{20}, T_{27}, T_{28} = \text{TUP}$
 $D_7, D_{11}, D_{12}, D_{13}, D_{14}, D_{19}, D_{20}, D_{21} = \text{DUS}$

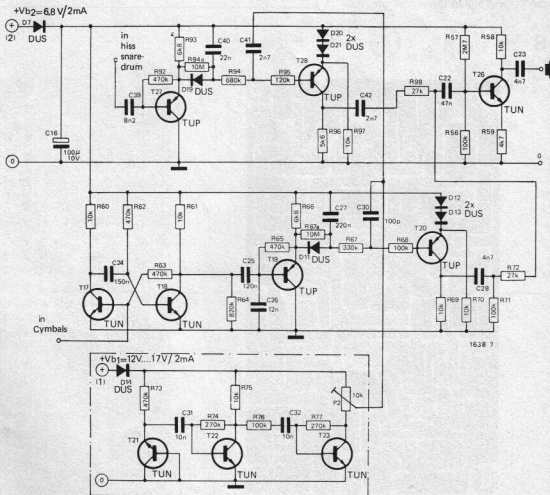

stretched across the drumhead. This is simulated in the Minidrum by filtered noise from the noise board, the circuit of which is given in figure 7. The cymbal, on the other hand, has no basic tone, but is simply filtered noise, which is also derived from the noise board.

The noise circuits operate in the following way. Noise is generated by T_{21} (about 5mV appears at the emitter) and is amplified by T_{22} and T_{23} . The noise amplitude may be adjusted between 0 and 3 V by means of P_2 . Noise for the snaredrum is applied to the junction of R_{94} and R_{95} via C_{41} . T_{27} is normally cut off which means that T_{28} is also cut off and the noise signal is blocked. When the snaredrum gyrotor is activated a pulse from the P' output appears on the input (C_{39}). This is differentiated and the negative going trailing edge briefly switches on T_{27} , thus rapidly charging C_{40} . T_{28} is thus biased on and the noise is amplified by T_{28} and T_{26} until C_{40} discharges and the voltage on the base of T_{28} falls below about 2 V when the transistor cuts off. The effect obtained is thus a 'thump' from the gyrotor followed by the 'tizz' from the noise board.

The cymbal noise circuit operates in exactly the same manner but it has its own monostable on the noise board driven directly from the TAP since the cymbal has no associated gyrotor board. T_{19} and T_{20} perform the same function as do T_{27} and T_{28} in the snaredrum noise

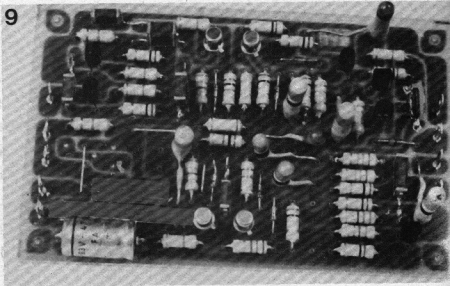

10

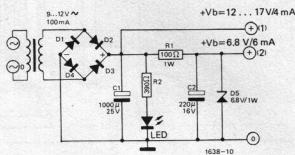

8

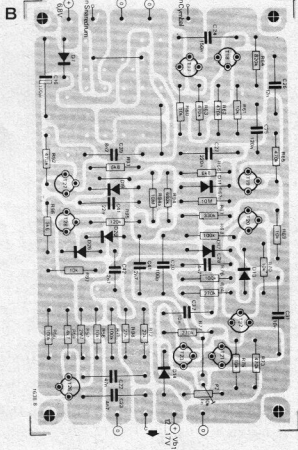
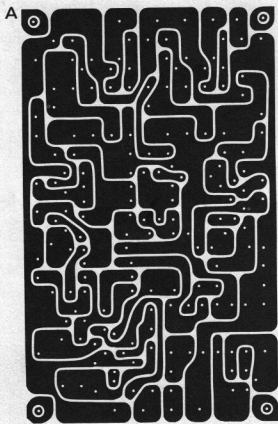

11

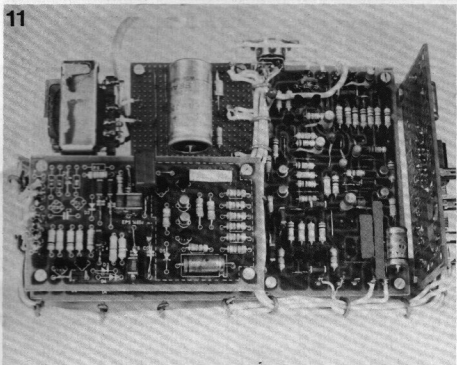

Figure 8a. The circuit board for the noise circuitry.

Figure 8b. The component layout of the noise board. The components for the monostable have been omitted in the snaredrum input.

Figure 9. A photograph of a completed noise board.

Figure 10. The simple power supply used with the Minidrum. The transformer should be able to supply about 100mA, at 9-12 V RMS.

Figure 11. The prototype of the Minidrum constructed at the Elektor Laboratories.

Figure 12. A mixer-preamplifier which may be used with insensitive power amplifiers. The gain is adjusted by means of P_1 .

Figure 13. The board and component layout for the mixer-preamplifier.

12

Components list to figures 12 and 13.

resistors:

R_{24}	= 22 k
R_{25}, R_{40}	= 10 k
R_{26}	= 27 k
R_{34}, R_{41}	= 470 Ω
R_{35}, R_{36}	= 150 k
R_{37}	= 680 Ω
R_{39}	= 8k2
P_1	= 220 k, preset

capacitors:

C_{11}, C_{14}	= 4 μ 7, 25 V
C_{12}	= 470 n
C_{15}	= 470 μ , 25 V

semi-conductors:

T_{10}, T_{11}, T_{12}	= TUN
D_6	= DUS

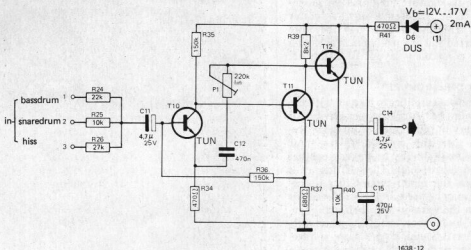

1638-12

13

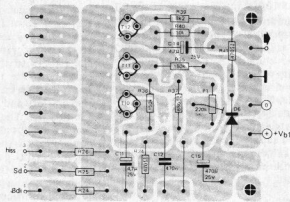
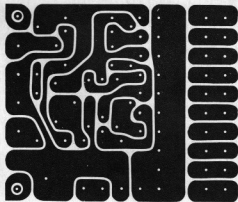

1638-12

Figure 14. Interconnection diagram for the complete Minidrum.

Figure 15. The complete Minidrum mounted in a perspex case. The copper furniture tacks used for the touch contacts can be clearly seen.

circuit. The cymbal noise is mixed with the snaredrum noise at the junction of R_{98} and C_{22} .

The noise board

The noise board of figure 8a and b has provision for a monostable on both inputs. These will be used in 'noise' instruments described in future issues. The snaredrum however requires no monostable as it is driven from the gyrotor board. This monostable may therefore be omitted and links soldered in as shown in the component layout of figure 8b.

Mixer preamplifier

If the power amplifier to be used with the Minidrum has sufficient sensitivity for the 50mV output produced by the instruments then the outputs of the three boards may simply be linked together and fed into the amplifier. If this is not the case the mixer-preamplifier of figure 12 may be used. In this case resistors R_{22} on the gyrotor boards should be replaced by a wire link. The mixer preamplifier is a simple two stage voltage-amplifier with virtual earth input and a low impedance emitter-follower output. P_1 is included to adjust the gain. The p.c. board and layout are given in figure 13. It will be noted that there are 10 inputs on the board but only 3 of these are used in the basic Minidrum.

Power supply

The Minidrum is fairly insensitive to interference so a sophisticated power supply is not required under normal domestic conditions (e.g. not in close proximity to heavy electrical machinery) and the circuit of figure 10 will be quite adequate. The +6.8 V supply for the instruments and the TAP is derived from a simple zener stabilizer D_5 and the unregulated supply for the mixer-preamplifier is taken directly from C_1 . The circuit may easily be constructed on a piece of stripboard.

Construction

Assembly of the complete instrument

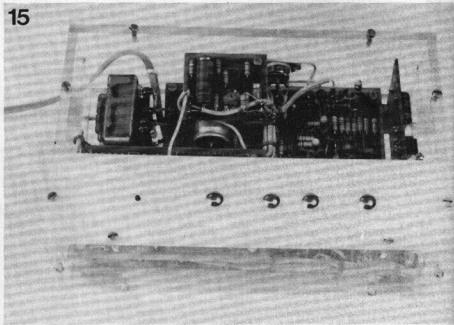
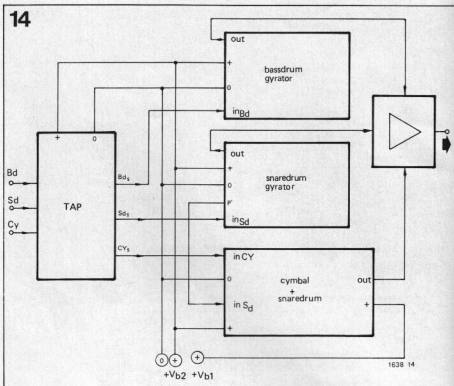

is a matter of personal preference and the photographs of figures 11 and 15 are merely a guide as to the type of layout. The prototype was mounted in a perspex box for visual purposes but from an electrical point of view a metal case is desirable for screening purposes.

In the photograph the TAP board is on the right with the noise board directly behind it. The two gyrotor boards are mounted one on top of the other at the bottom left and the power supply is at the top left. The main points to remember in the construction are that the connections to the touch contacts should be as short as possible, as should signal connections between boards. Screened leads may be used if necessary with the braiding connected (at one end only) to the supply common. Copper-plated furniture tacks are ideal for the touch

contacts as they are easy to solder and practically immune to oxidation. The panel carrying the contacts must be of an insulating material such as perspex or paxolin.

For ease of construction the Minidrum may be assembled using boards available from Elektor.

sonant

One of the weaker links in the sound reproduction chain has always been the loudspeaker. The

physical problems involved in loudspeaker design are more severe than those occurring elsewhere in the chain — but this is no reason for failing to face them.

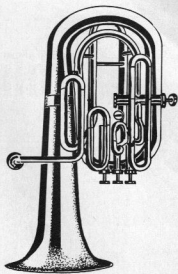

A loudspeaker can be defined as a 'more or less linear convertor of electrical to acoustical power'. One can now attempt to make detail improvements to the conversion mechanism (flattening its power-frequency response or reducing its non-linear distortion etc.), or one can look for a different approach to the entire conversion problem (e.g. electrostatic drive!). Still another approach is perhaps more fundamental: combine a power amplifier, a transducer (loudspeaker) and an error-correcting system to form a 'linear convertor of electrical voltage to acoustical amplitude'.

This approach is sufficiently new to merit a new name. We suggest the name 'Sonant'. An example of such a design is the 22RH532 Electronic, recently introduced by Philips (see the article 'Philips Sonant' elsewhere in this issue). The introduction of a low-distortion voltage-to-sound convertor would mean that all the links of the sound reproduction chain reached an acceptable level of performance. It seems desirable to do

a little rethinking about the whole sound reproduction process, in the light of the changed situation.

Figure 1 shows a block diagram of the reproduction chain using sonants. The figure also shows the influence of various links on the frequency characteristic, stereo balance, stereo width and '0 dB' reference level. The influence on the level is important when a loudness-contour correction is to be used.

The reproduction chain includes a 'pre-sonant'. This is the link which applies the corrections necessary to attain the desired overall characteristics in the face of errors elsewhere in the chain. Essentially this function can be performed by a normal control-amplifier. Optimum convenience of operation, however, requires some rather different control arrangements:

— **tonal balance.** Assuming that the recording staff have done their job properly, it should only be necessary to make tonal balance adjustments which will offset the effects of the

listening-room acoustics on the frequency characteristic. A once-only adjustment of preset controls is then sufficient.

- **stereo balance.** This is somewhat dependent on the positions of the sonants in the room. A preset adjustment will once again suffice.
- **stereo width.** This is also somewhat dependent on the sonant positions. It is furthermore very dependent on the personal taste of the recording engineer, so that a control providing some range of variation is desirable. Experience has taught that four switched conditions are adequate: mono — 'half stereo' — stereo — 'wide stereo'.

— **level.** The requirements to be met by the contour compensation depend on the actual reproduction level at any given moment. However, the '0 dB level' may be 100mV for example from a disc preamplifier, 300mV from an FM tuner and 1000mV from a tape recorder. It is therefore necessary to match levels from the various inputs. The final requirement is for a **volume control** fitted with the loudness-contour compensation circuit. Once again experience teaches that the number of settings can be drastically pruned. What about: background — moderate — normal music reproduction — shattering?

It will be clear that most of the front panel controls disappear. These were in the past used mainly to compensate for imperfections in the recording- or playback-equipment. The operating procedure now becomes much simpler: 'select programme', 'select loudness' and (for the time being?) 'select stereo width'. The well-known complexities of operating audio equipment have now been replaced by the ease of operation of a TV set (once properly adjusted!). Design work is at the moment in progress on a complete elektor-sonant, along the above lines.

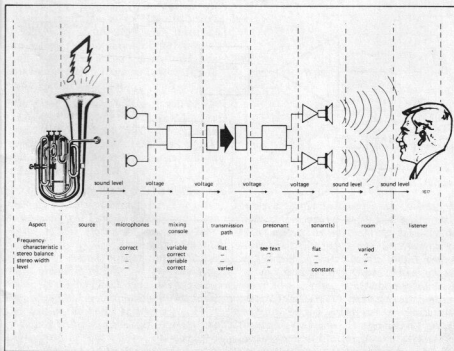

philips sonant

In the article "sonant", elsewhere in this issue, a definition is given of a new type of

"active" sound-reproducer design, in which the radiated sound (pressure) level is linearly dependent upon the electrical signal (voltage) applied to the input. This approach differs fundamentally from the classic 'passive' loudspeaker system design, where electrical input power is converted — with limited linearity — into radiated acoustical power. Passive systems are either particularly poor in low-frequency linearity or else they are very bulky. On the other hand, active systems with good low-frequency performance can be quite compact.

A practical realisation of the sonant-principle is to be found in the recently presented Philips 22RH532 "Electronic". This article describes a few aspects of the way in which this sonant operates.

It is well known that the performance of most loudspeakers is far from ideal. The designer of a complete system is invariably forced to make compromises between size, shape, efficiency, directionality, distortion, amplitude response ... and price. The attempt to achieve really good performance via the classic approach nearly always fails. The performance in the bass register, in particular, only becomes acceptable as the enclosure or system becomes too large for domestic listening-room convenience. The possibility now suggests itself of circumventing the mechanical-acoustical problems by electronic means. One possible approach is to make use of a power amplifier with a negative output impedance, which can compensate for some of the drive-unit's DC resistance and so obtain better control of the coil movement. Examples of this approach are the "Electronic loudspeaker" (Elektor sonant) and a commercially-available system called "Servosound".

The difficulty with this approach is that the systems have to use current-dependent positive feedback around the power amplifier, which means that the optimum adjustment is fairly critical. A different approach becomes possible when the loudspeaker is equipped with some form of motion-sensing device. One can then apply overall negative feedback to the complete amplifier-driver system: so-called 'motional feedback'. This approach is what has been realised in the woofer channel of the Philips sonant. It should be noted that neither of these ideas is new. The negative-output-impedance approach was described as far back as 1940, by nobody less than Harry F. Olson. The motional feedback approach using an accelerometer was first tried at least ten years ago. The difficulty was to design a reliable system, not too expensive — and suitable for mass production!

Principle

Figure 1 is a block diagram of the complete sonant. It is clear that motional feedback is only applied to the woofer

channel, the classic approach being adopted for the mid-range and the treble. In contrast to the "electronic loudspeaker", this design employs a single amplifier for the mid- and treble-ranges, in conjunction with a passive dividing network.

The bass register (35–500 Hz) is handled by the feedback system. This subchannel consists of a 40 watt amplifier, the bass transducer with accelerometer and a feedback network.

The feedback network actually contains an impedance-matching circuit for the piezo-electric acceleration-pickup, a preset gain control and a set of stabilising filters.

Before examining the system in detail it will be interesting to see what results are actually achieved in practice.

Results

The volume of the actual woofer enclosure is only 15 litres, the overall outside dimensions being 28.5 x 38 x 22cm. A copy of Elektor, folded out flat, is

therefore rather larger than the system's front panel! The complete electronic 'works' (amplifiers, filters, power supply) are mounted inside the 'box', as can be seen in the photograph (figure 2). In a small enclosure such as this the fundamental resonant frequency is about 80 Hz, but the feedback arrangement prevents this having any effect on the amplitude response. This response-characteristic is sketched in figure 3. The 3dB rolloff-points are shown at about 35 Hz and 20 KHz. The dotted curve shows what happens when the feedback is made inoperative — more than an octave of bass response is lost!

A further advantage of the use of feedback is that the distortion is reduced. This is shown in figure 4. One should bear in mind, at this point, that the subjective effect of loudspeaker distortion is quite different to that of the usual kind of distortion in the (power) amplifier. A good amplifier is substantially free of perceptible distortion until it is actually

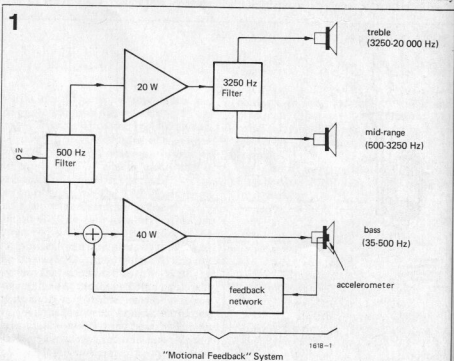

Figure 1. Block diagram of the Philips sonant. Frequencies up to 500 Hz are reproduced via a motional-feedback woofer system.

Figure 2. The sonant. The electronic 'works' are mounted on the inside of the hinged rear panel, which doubles as a heat sink.

Figure 3. Amplitude-frequency response of the sonant. The solid line shows the response with motional feedback in operation; the dashed line shows what would happen if there were no motional feedback.

Figure 4. Distortion characteristic at nominal output. The solid line indicates the distortion with motional feedback operative. Removing the feedback results in the much higher dashed curve values. See the text for an interpretation of these curves!

overdriven, when it suddenly starts to produce sharp-edged waveforms containing musically-unpleasant high order components. Loudspeaker distortion at low frequencies, on the other hand, consists mainly of third harmonics. This low-order distortion merely disturbs the balance between fundamental and naturally-present harmonics in the instrument being reproduced, causing relatively acceptable 'colouration' of the sound.

The curve in figure 4 can be viewed as follows. Assume that the loudspeaker is operating without feedback and is being nominally fully driven with a pure 30 Hz tone. The delivered output will consist of 76% fundamental (30 Hz) and some 24% third harmonic (90 Hz). The loudspeaker with feedback will (under equivalent conditions) produce 92% fundamental and only about 8% third harmonic, so that the reproduction will sound much less 'coloured'. At still higher (overdrive) levels the effect will become still more pronounced: operated without feedback the loudspeaker will produce as much as 80 to 90% distortion, reducing to about 30% with feedback operative. The operation of the feedback is then to increase the amount of fundamental produced from as low as 10% to some 70% of the total.

The great increase in the level of the fundamental inevitably makes the reproduction more natural-sounding, more 'realistic'. One then overhears remarks like: "It is as if there is no longer a loudspeaker getting in the way".

It is to be expected that this performance can only be obtained at a price. The price to be paid was already mentioned in an earlier article ('electronic loudspeaker' Elektor no. 1) - it is simply that the amount of sound output obtainable at 'flat' power-response is considerably lower in the feedback case. Maintaining the loudspeaker's amplitude response flat below the point at which the basic system naturally rolls off implies the application of 'brute force' by the feedback drive. Extending the response by an

2

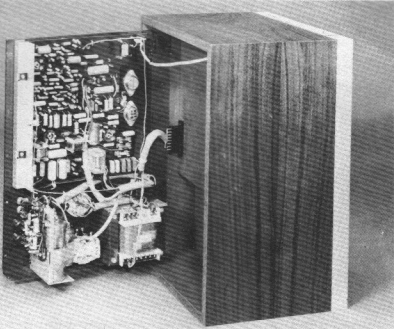

3

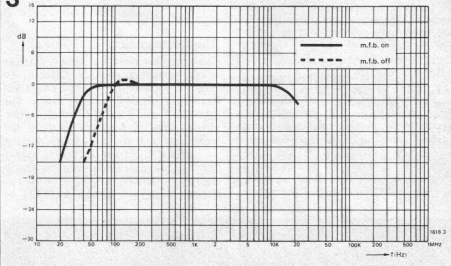

4

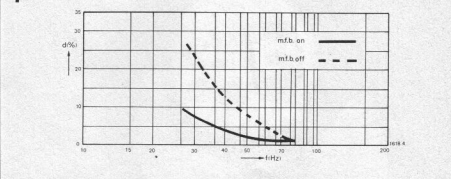

octave would in fact require the amplifier rating to be increased more than 10 times. Any attempt to actually do this is of course to risk destruction of the driver - which in the Philips case is rated (as is the associated power amplifier) at 40 watts. The seemingly-obvious assumption that the power-response should be flat leads to the conclusion that the amplifier, at nominal output of the system above the natural rolloff frequency, always operates well below the

level of which it is capable. Fortunately the assumption is incorrect!

The continuous line in figure 5 is a contour for the maximum level encountered in 'typical recordings' as a function of the frequency. It was derived from measurements performed on a large number of disc records. The dashed line is a contour which applies to one or two extreme-case recordings (e.g. Decca's 'Zarathustra'). It may be pointed out that the extremes below 100 Hz are

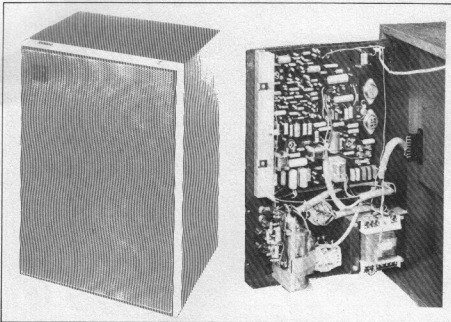

rarely encountered ('Zarathustra' or Saint-Saëns 'Organ Symphony'); but that the treble-range extremes are more common (e.g. percussion and synthesizer-effects in pop-recordings). This higher contour can be exceeded by 6 to 10dB during momentary signal peaks, mainly in the mid-range up to about 3 KHz. The right-hand vertical scale in figure 5 has been chosen to represent fairly loud music reproduction (as typically encountered in monitoring rooms during classical recording). The dash-dot contour indicates (to this scale) the maximum level of which the Philips sonant is capable in a fair-sized domestic listening room. It will be clear that the system

is capable of handling the 'peak programme level' discussed above at all frequencies higher than its 35 Hz amplitude-response rolloff point.

The electronics

The complete electrical circuit diagram of the sonant is given in figure 6. To improve the readability of this diagram it has been divided into sections. The sections A and B are the 'woofer' drive circuit and its feedback system; the mid-range and treble channel consists of sections C, D and E; power supply section G, finally, is controlled by signal-dependent shutdown F.

The first part of section A (T421 to

T423) is an active bandpass filter with cutoff frequencies of approximately 35 Hz and 500 Hz. The motional feedback signal is injected via C 506. The operating principles of such filters are (or should be) well enough known. The remainder of section A is a normal class B power amplifier, with an operating bandwidth of 5 Hz to 2 KHz and rated at 40 watts. It meets all the requirements of this application. One or two design details may be worth noting:

- the differential input pair T 424 and T 425, necessary to prevent 'disagreement' between the various feedback paths (C 506/R 603/T 423, R 611/C 504 and R 623/C 509/R 622/C 511/R 619).
- the extensive filtering in the above-mentioned feedback paths, which are designed to optimise the overall amplitude- and phase-characteristics of the system as a whole.
- the application of power-Darlington's in the output stage.
- diode D 456, which 'clamps' the base-voltage of T 430 whenever this attempts to exceed the supply-rail voltage as a result of the 'bootstrapping' via C 513.

In section B a dotted rectangle is shown enclosing the drive-unit itself, the accelerometer and an impedance-matching stage. The pickup device proper, plus an FET and two resistors, are mounted on a small PC board glued to the leading edge of the drive-coil former (figure 7). The pickup device is a small ceramic plate, suspended in an opening of the PC board by means of rubber blocks. The voltage delivered by the pickup is proportional to the force it experiences, which in turn ($f = M \cdot a$) is proportional to the acceleration. The moving mass is in fact largely due to the solder droplets — so that these must be carefully controlled in size! Inevitable production tolerances can be corrected by means of preset potentiometer R 654. The ceramic plate performs best when looking into an extremely high impedance, which is the reason for using an FET. Installing this FET beside the pickup, rather than on the main PC board, avoids problems with hum and instability.

The circuit around T 433 combines the functions of maintaining the FET at the correct operating point and of extracting the output signal for further processing. The remainder of section B is a filter-amplifier. It delivers a signal strong enough for injection into the main channel, at the same time arranging for unconditional stability of the feedback system.

The power amplifier circuit for the mid-range and treble loudspeakers (section C) closely resembles that in the woofer channel. In this case however the 500 Hz high-pass filter is built up around the first transistor of the amplifier itself (T 439). The output stage is biased to a quite high value of standing current (about 200mA), i.e. in class AB, to eliminate any possibility of crossover distort-

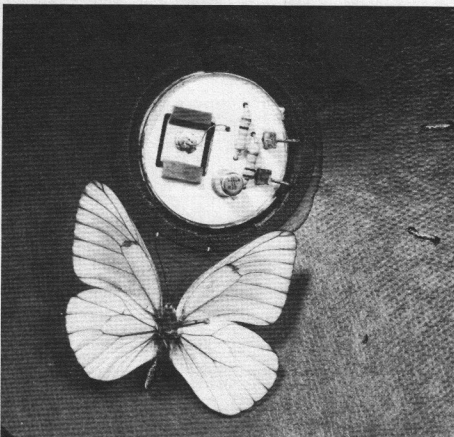

amplifier passes through the dividing network (section D) to drive the loud-speakers of section E.

The circuit of section F is a kind of automatic supply switch. With mains applied and the on/off switch depressed there will be DC on the '+2' and '+3' supply rails. An input signal delivered to the sonant at a level higher than about 1mV will, after being amplified and rectified, cause the Schmitt trigger in section F to change state and so pull down relay S 402. This turns on the feed to the power amplifiers, within 1 second of the arrival of a signal. If the signal is interrupted for more than about 3 minutes, the circuit assumes that the sonant is no longer required and shuts down the power amplifiers.

The actual power supply circuit (section G) is fairly standard. Special attention has been paid to the feed for critical circuits ('+3'): T 451/T 452 provide extra smoothing by what is in fact gyrator-action. An additional effect of this arrangement is to cause the feed voltage to rise slowly after application of the mains, thus eliminating 'thump'. The circuit including R 726, R 727 and D 471 is an interesting design-gimmick: the supply indicator lamp L 414 is arranged to glow dimly so long as the sonant is dormant with mains 'on', via R 726 and R 727. When the amplifier feed is turned on, however, D 471 effectively short-circuits R 726, so that the lamp glows at normal brightness. This provides, if nothing else, a 'standby'

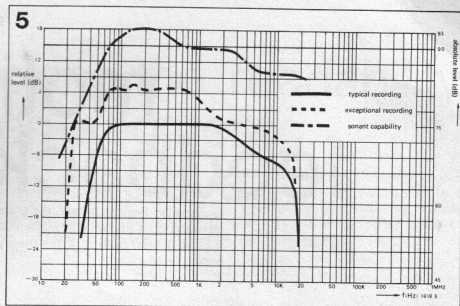

condition for the lamp! However, our most recent information indicates that this feature has been omitted from the latest models: the lamp switches on and off together with the amplifiers.

Figure 5. Contours of maximum level against frequency. The solid curve indicates the levels encountered in typical music recordings; the dashed curve shows higher levels occasionally encountered. The right-hand scale is chosen to represent fairly loud reproduction (classical monitoring); the dash-dot line shows the sonant's peak programme capability to the same scale.

Figure 6. Complete circuit diagram of the sonant. 'A' and 'B' form the motionial feedback woofer-channel; 'C', 'D' and 'E' are sections of the mid-range/treble channel; 'F' is the signal-sensing power-shutdown; 'G' is the power supply section.

6

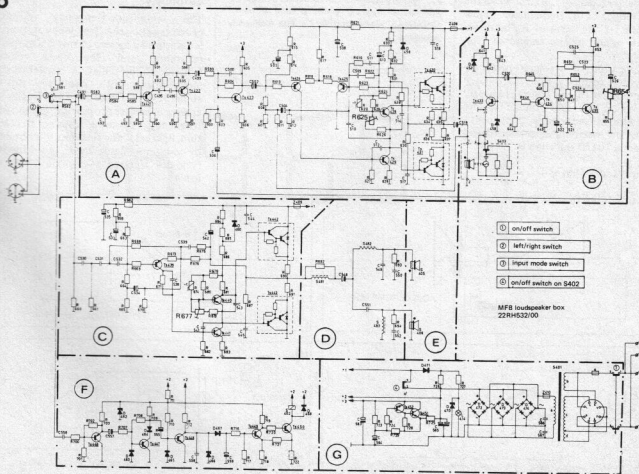

motional feedback

Many people are quite satisfied with the musical pleasure they can obtain from a well-designed reproducer. For the others, the pleasure is heightened by the intellectual satisfaction of knowing how the thing works and why it sounds the way it does. A brief outline of the theory of motional feedback is therefore in order.

A good starting point is to take a look at the arrangement chosen for the 22RH532 'Electronic': a loudspeaker driver fitted with an accelerometer, mounted in a stiff airtight enclosure.

This arrangement is shown in the block diagram of figure 1. The acceleration of the cone is measured, the derived voltage being applied as negative feedback. A short calculation will show that this is the best approach. The radiated acoustic power (P_a) is given by:

$$P_a = u^2 \cdot R_a$$

where u is the 'particle velocity' (equal to the cone velocity) and R_a is the 'radiation resistance' (real part of the air-load on the moving cone). For frequencies below about 500 Hz the value of R_a increases with the square of the frequency (figure 2).

The application of acceleration-dependent negative feedback will tend to keep the acceleration of the cone (a) linearly dependent on the input voltage (v_i) and independent of frequency.

The relation between acceleration (a) and velocity (u) of the cone is:

$$u = a \cdot t \text{ so that } u \sim \frac{a}{\omega} \sim \frac{v_i}{\omega}$$

Figure 1. Block diagram of a motional feedback system making use of an accelerometer.

Figure 2. The radiation resistance (R_a) of the air-load on a typical moving-coil loudspeaker in box increases (up to about 500 Hz) with ω^2 . Since it is the radiated power that is proportional to R_a , the output at constant cone velocity would rise at 6dB/octave.

Figure 3. Constant acceleration means a cone velocity that is inversely proportional to ω . This velocity is proportional to the square root of the radiated power. So u can be plotted as a -3dB/octave slope.

Figure 4. The radiated acoustical power is proportional to the product of radiation resistance and velocity squared. Combination of figure 2 with twice figure 3 yields a total slope of 0dB/octave below 500 Hz i.e. flat frequency response!

Since a is independent of ω in this case, the velocity will be inversely proportional to frequency (figure 3). This leads to:

$$P_a = u^2 \cdot R_a = C \cdot \frac{1}{\omega^2} \cdot \omega^2 \cdot v_i^2$$

where C is a constant. (If we ignore box dimension- and room position-effects!) The relationship between radiated sound power and input voltage is therefore independent of frequency (figure 4). In other words, the amplitude-frequency response characteristic is flat.

Summary

The amplitude-frequency response characteristic (the 'frequency response') is determined by two terms: the radiation resistance and the cone velocity (squared). The radiation resistance rises quadratically with frequency (up to about 500 Hz, figure 2). The velocity decreases in inverse proportion to the rising frequency (assuming constant acceleration, figure 3). The final result is obtained by combining figure 2 with twice figure 3 (velocity squared!) — which yields figure 4.

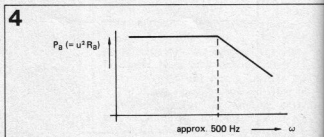
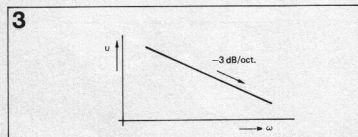
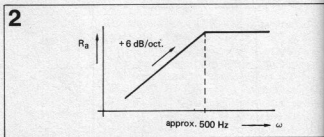
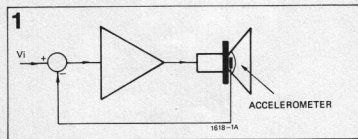

improving the readability of seven-segment displays

Seven-segment displays of various types are now the most popular format for digital display in many applications. The most common decoder-driver used with these displays is the 7446 (or 7447) which may be used with displays of the LED or Minitron type.

The results obtained with these decoders are, in general, very good, but the format of the digits 6 and 9 leaves something to be desired. These digits are decoded as shown in figure 1b and most people would agree that they are greatly improved by the addition of segments 'a' and 'd' respectively, as in figure 1c. The Japanese tend to use this presentation in their electronic calculators.

This format may be obtained with the 7446/7 by paralleling the 'a' and 'd' outputs with external transistors which are turned on when either a 6 or 9 is displayed (see figure 2). The only problem is to derive a suitable code from the BCD input to drive the transistors. A '1' must be applied to the base of the appropriate transistor when either a 6 or 9 is displayed.

Looking at the truth table for the 7446/7 it is apparent that when a 6 is displayed columns B and C of the BCD input code are '1'. Column C cannot be used, however, for looking at the rest of this column it can be seen that column C is also a '1' for digit 4. Since 4 does not utilise segment 'a' input C cannot be used to drive the transistor for this segment. Input B may be used however since the other digits with a '1' in this column are 2, 3 and 7 which all use segment 'a'.

Turning to digit 9 it can be seen that there are '1's' in columns A and D of the BCD code. A obviously cannot be used since digit 1 also has a '1' in this column but does not contain segment 'd'. Column D may be used, however, since the only other digit with a '1' in this column is 8, which contains segment 'd' anyway.

Figure 1. a. Alphabetic designation of the seven segments of a display. b. Usual format of digits 6 and 9. c. Improved format of digits 6 and 9.

Figure 2. The output stage of a 7446/7 seven-segment decoder with the external transistor in parallel.

Figure 3. The complete circuit for the improved readability display using a 7447. The 7446 has an identical pinout.

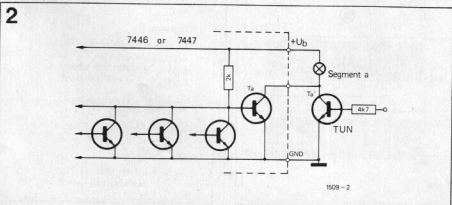
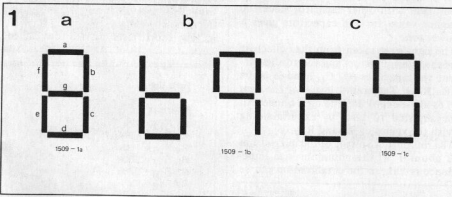

Truth table for the seven-segment decoder without the additional transistors.

Digit	D	C	B	A	a	b	c	d	e	f	g
0	0	0	0	0	0	0	0	0	0	0	1
1	0	0	0	1	0	0	1	1	1	1	1
2	0	0	1	0	0	0	1	0	0	1	0
3	0	0	1	1	0	0	0	0	1	1	0
4	0	1	0	0	1	0	0	1	1	0	0
5	0	1	0	1	0	1	0	0	1	0	0
6	0	1	1	0	1	1	0	0	0	0	0
7	0	1	1	1	0	0	0	1	1	1	1
8	1	0	0	0	0	0	0	0	0	0	0
9	1	0	0	1	0	0	0	1	1	0	0

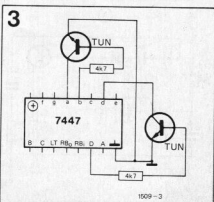

microdrum

Linking up more or less with the minidrum published elsewhere in this issue of *Elector*, this

article describes the simplest member of the electronic drum family, to wit: the microdrum. In this micro version the number of instruments has been limited to two: one high and one (very) low bongo. Only two transistors are needed to make an instrument that can be connected directly to any power amplifier.

Neglecting the cost, the obvious choice of instruments for the microdrum would be a bassdrum and a snaredrum. However, the accurate imitation of a snaredrum requires quite a number of components because of the necessity for a noise generator, so that its application in a simple and, above all, inexpensive little "drumbox" is less attractive.

For this reason, the instruments chosen for the microdrum described here are a bassdrum and a high bongo. In addition, to simplify matters even more, the sound of the bassdrum was lifted by one octave so that expensive bass loudspeakers are not required for reproduction. The result is a combination of a very low and a very high bongo.

The circuit

Figure 1 shows the circuit diagram of the microdrum. The bass sound is produced by means of the oscillator comprising T_1 (this is the low bongo sound); the oscillator built around T_2 represents the high bongo. Both oscillators are so designed that they are inoperative when the push button switches S_1 and S_2 are open. As can be seen in the diagram, the

oscillators are of identical design. If S_1 or S_2 is pressed, a positive pulse appears on the base of the corresponding transistor. The shape of this pulse is determined by a circuit consisting of C_1 , R_1 and C_2 for the bass oscillator and C_7 for the bongo oscillator. In contrast to the bass, the bongo has no parallel capacitor across R_{12} ; hence the sound of this instrument is sharper.

The discharge time, and thus the duration of the pulse, is determined by the values of R_5 and R_6 , and R_{17} and R_{16} respectively. The pitch of the bass oscillator depends on the values of C_3 , C_4 and C_5 ; the pitch of the bongo is governed by the values of C_8 , C_9 and C_{10} . Where C_3 , C_4 and C_5 are concerned, the best values found to lie between 10nF and 47nF; the best values for C_8 , C_9 and C_{10} are between 4n7 and 10nF.

Of course, everybody is quite free to experiment with other capacitor values. A higher value for the capacitors gives a lower tone.

The signals are taken from the collectors of the two transistors and fed to the output via capacitors (C_6, C_{11}) and resistors (R_9, R_{20}). The sound levels of the bass (i.e. low bongo) and the high bongo can be adjusted to taste by experimenting with the values of R_9 and R_{20} .

The rms output voltage of the microdrum is about 1 V; the minimum load impedance is 18k, so the combination can be

connected to almost any power amplifier. The supply voltage can lie between about 15 V and 24 V. If mains supply is used, it need not be stabilized. As the total current consumption is no more than about 5mA, the apparatus also performs well when fed from torch batteries. Even if used intensively, these batteries will last for months.

Figure 2 shows the printed circuit, and figure 3 shows the component arrangement. The modest dimensions (abt 7.5 x 5 cm) leave ample possibilities in choosing a suitable cabinet.

Additions

As already explained, the sound of the instruments can be changed by using other values for the capacitors C_3 , C_4 and C_5 (for the bass), and for C_8 , C_9 and C_{10} (for the high bongo). It will be clear that further experimentation can lead to entirely different instruments whilst using the same oscillators.

A few short tests carried out in the

Figure 1. Circuit diagram of the microdrum. The sound levels of the bass and bongo can be adjusted to taste by experimenting with the values of R_9 and R_{20} .

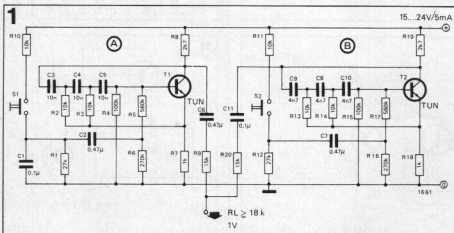

Parts list

Resistors

- $R_1, R_{12} = 27k$
- $R_2, R_3, R_{10}, R_{11}, R_{13}, R_{14} = 10k$
- $R_4, R_{15} = 100k$
- $R_5, R_{17} = 560k$
- $R_6, R_{16} = 270k$
- $R_7, R_{18} = 1k$
- $R_8, R_{19} = 2k7$
- $R_9, R_{20} = 15k$ (see text)

Capacitors

- $C_1, C_{11} = 0.1 \mu$
- $C_2, C_6, C_7 = 0.47 \mu$
- $C_3, C_4, C_5 = 10n$ (see text)
- $C_8, C_9, C_{10} = 4n7$ (see text)

semiconductors

- $T_1, T_2 = TUN$

Miscellaneous

- $S_1, S_2 =$ single pole push button switch

Elektor laboratories have indicated that changing the values of C_8 , C_9 and C_{10} to $2n7$, produces a sound rather like wooden blocks.

It might therefore be attractive to extend the microdrum with one or more identical p.c. boards, each with different capacitors.

universal display

It is frequently necessary to have available a numeric display for many projects such as frequency counters, digital voltmeters etc. It is a tedious and untidy business to build up such displays on matrix board, so Elektor have designed a universal display which should satisfy the requirements of most enthusiasts. The display may be used with seven-segment indicators of the LED or Minitron type.

Figure 2. A simple, yet complete electronic musical instrument on a printed circuit board of no more than 7.5×5 cm!

Figure 3. Component arrangement on the board of figure 2.

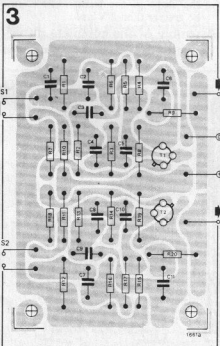
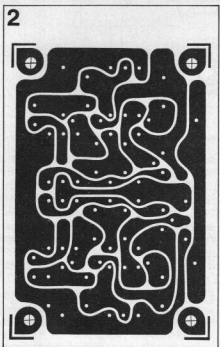

The universal display is modular in construction and its basic form consists of a board to accommodate two displays and their associated decoders. The system may be extended to any number of digits and decade counter/latch boards may also be added.

The universal display uses the popular 7447 decoder. The display format of this decoder is given in figure 1. However, for digits 6 and 9 the improved format described elsewhere in this issue is employed. This is shown in figure 2. The basic configuration of the decoder with the additional transistors is shown in figure 3 and the complete circuit of a display module for use with LED displays is given in figure 4. That of the Minitron version is shown in figure 5, the only difference being that the Minitron does not require current-limiting resistors in series with each segment.

Construction

Double-sided boards are employed in the construction of the display module and it may be seen from figures 6 and 7 that components are mounted on both sides of the board. It should be emphasised here that great care is required in the assembly of these boards due to the degree of miniaturisation involved. The soldering iron must have an extremely fine tip and soldering must be done extremely quickly to avoid peeling the fine track from the board. The boards available from Elektor employ plated-through holes, so that it is unnecessary to solder to component leads on both sides of the board. Simply solder on the opposite side of the board to that on which the component is mounted.

The counter/latch module

The counter/latch module increases the

Figure 1. The display format produced by the 7447 decoder.

Figure 2. The improved presentation of the digits 6 and 9 as used in the universal display.

Figure 3. The circuit used with the 7447 to achieve the improved 6 and 9 display.

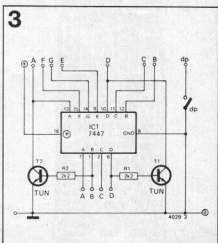
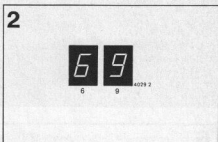
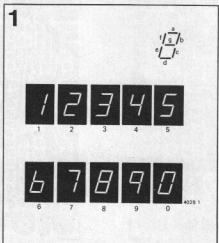

4

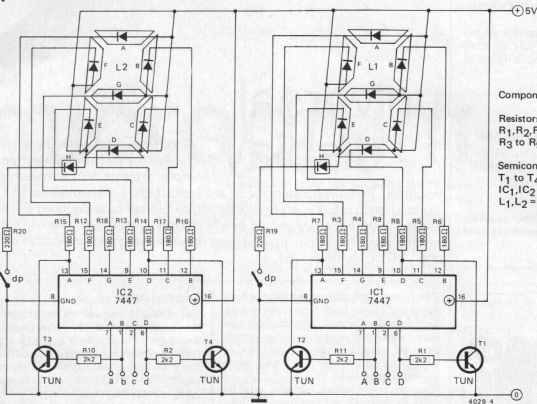

Components list for figure 4:

Resistors:

$R_1, R_2, R_{10}, R_{11} = 2k\Omega$
 R_3 to R_9, R_{12} to $R_{18} = 180\Omega$

Semiconductors:

T_1 to $T_4 = \text{TUN}$
 $IC_1, IC_2 = 7447$
 $L_1, L_2 = \text{e.g. H.P.5082-7730 or 7750, Opco's SLA 1, T.I. Til 302, Data Lit DL 707.}$

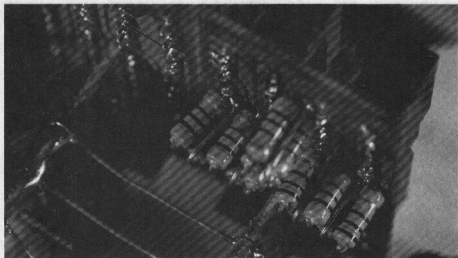

versatility of the universal display to a large extent. The circuit of the module is given in figure 8 and consists of two cascaded 7490 decade counters and two 7475 latches. The operation of these devices will not be discussed in detail as they are extremely commonplace; suffice it to note the following points:

- the latch is enabled by a '1' on the clock input.
- the counter counts on a negative-going edge.
- the counter is reset by a '1' on the reset input.
- for reliable operation of the counter the slope of the pulse edges should be greater than $2\text{ V}/\mu\text{sec}$.

Assembly of the complete display
 The board and layout for the counter/

6

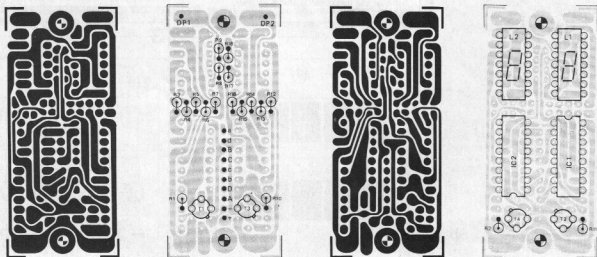

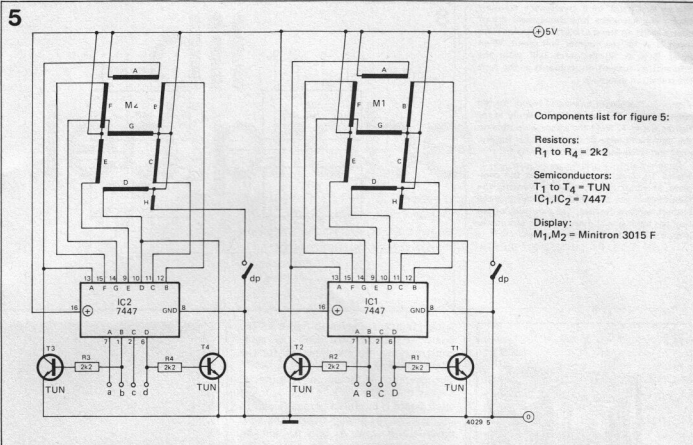

Figure 4. Circuit of the LED version of the universal display. Note that the decimal point series resistor has a higher value than the segment resistors to achieve the same luminous intensity.

Figure 5. The Minitron version of the display which does not require series resistors for the segments. Note that the Minitron has a right-hand decimal point whilst the LED displays used have a left-hand decimal point.

Figure 6. The p.c. board and layout for the LED display. The track shown in feint in the component layouts is the side of the board on which the components are mounted, i.e. the components are mounted directly on top of the track shown.

Figure 7. The board and component layout for the Minitron display. The same remarks apply as for the LED display.

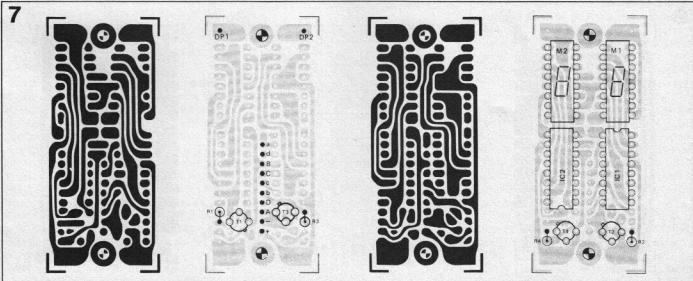
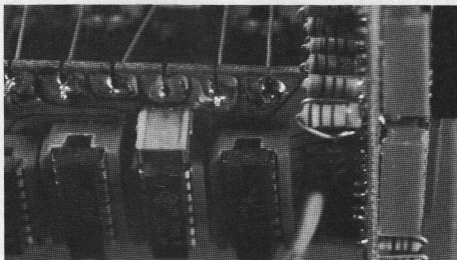
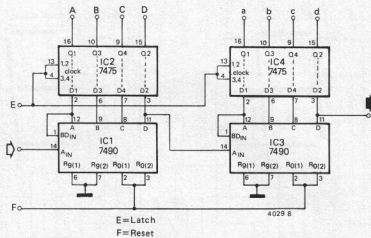

Figure 8. Circuit of a two-decade counter/latch. The necessary interconnections are of course made on the p.c. board. When the reset input is at '0' the counter will count. When input E is at '0' the latch will store the information present on its inputs at the time the transition occurred.

Figure 9. The circuit board and layout for the counter/latch. The same remarks apply as for figures 6 and 7. Note the connection slots on the right-hand edge of the boards for supply, reset and latch-enable busbars.

Figure 10. A cut-away drawing of the complete universal display module showing the mounting of the counter/latch board and the busbars to other decades. The mounting of the counter latch board must be done accurately if several modules are to be cascaded.

8



10

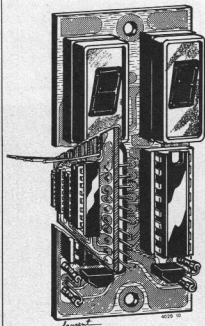

latch module are given in figure 9. The board is double-sided and the same constructional points apply as for the display module.

The assembly of the complete universal display requires some care. The counter/latch board is mounted perpendicular to the back of the display board. The BCD outputs a, b, c, d, A, B, C, D, and the supply connections on the edge of the counter/latch board mate up with the corresponding connections down the middle of the display board. The method of construction is as follows: sufficient right-angle links are made from stout copper wire and soldered to the counter/latch board so that they stick out parallel to the plane of the board but perpendicular to the edge. The links are then pushed through the back of the display board so that the edge of the counter/latch board is flush with it and are then soldered (see figure 10).

Interconnection of several boards

Any number of modules may be easily interconnected to form a decade counter of any desired length. The modules are first joined mechanically by using 6 B.A. spacers and short lengths of 6 B.A.

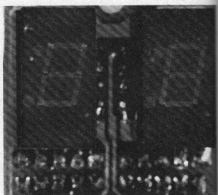

studding through the hole in the corner of the counter/latch boards. All the common interconnections between the boards, i.e. supply connections, counter reset and latch enable are made simply by running a wire bus in the slots on the top edge of the counter/latch boards. The counters are cascaded by connecting a wire link from the output of one stage to the input of the succeeding stage again on the top edge of the counter latch boards (remember to connect the output of a board to the input of the board to its left). The photograph should make this clear.

9

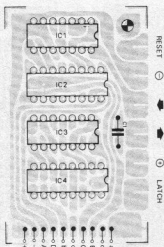

dil led probe

The use of digital ICs has increased over the years to such an extent that by now on

average four to five ICs are used in a relatively small circuit. This does not make trouble shooting any easier; for this reason a universal tester was designed which can be used for testing ICs under operating conditions. The probe discussed in this article is suitable for testing 14- and 16-pin dual-in-line ICs.

Although in principle the probe is suitable for TTL-DTL- and cos/mos ICs, it is not recommended for use with the latter. In the first place the supply voltage for cos/mos ICs covers too wide a range (between 3 V and 15 V). In the second place many cos/mos ICs can only deliver (or sink) a very small load current, so that the digital IC-probe may give erratic indications.

If the probe is to be used universally for DTL- and TTL-ICs, several requirements will have to be met. For ease of use, the probe must be able to function without an extra power supply. TTL- and DTL-ICs have a supply voltage between about 4.75 V and 5.25 V - apart from a few exceptions. This supply voltage for the IC under test must also provide the supply for the probe itself. The complete probe should draw as little power as possible from the IC under test, in order not to disturb the functioning of the circuit. In the design this has been achieved by using buffer ICs which ensure that the IC under test is hardly loaded, apart from the supply.

The best way to obtain a simple test procedure is to have two rows of LEDs on the probe, each one corresponding to one pin of the IC under test. Each LED will light up if the corresponding pin is at the '1' level. Consequently, a dark LED indicates that the pin is at '0' level.

The supply

Certain problems arise from the requirement that the probe must be fed from the IC under test. The supply is not always at the same pin; for 14-pin ICs and 16-pin versions there is a certain amount of standardisation, but with so many exceptions that the probe must be able to locate the supply connections on any of the 14 or 16 pins. In its simplest form a 'supply finder' can be made as shown in figure 1. If in this figure point X has a positive voltage, this voltage will also be available on point A. A zero potential at point X will be passed on to point B. Because there can be up to 16 IC pins from which the supply must be found,

Figure 1. A single 'supply finder'.

Figure 2. A supply locator with three inputs.

Figure 3. A single supply locator with corresponding LED indicator.

Figure 4. A complete supply locator with inverter and LED, of which 16 are needed.

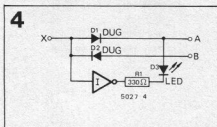
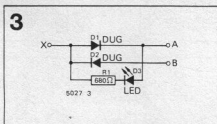
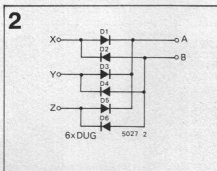
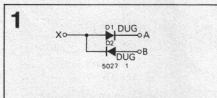

the circuit of figure 1 must be repeated 16 times.

To clarify matters, figure 2 shows a 'supply locator' with three connections (X, Y and Z). If on one of these connections, say X, there is a positive voltage, whereas point Y is at zero potential, the given supply voltage between X and Y is also available at points A and B. Because of the diodes, the voltage between the points A and B is twice the diode threshold lower than the voltage between X and Y. To keep this voltage drop at a minimum, it is better to use germanium diodes (DUG) than silicon types (DUS). Since a '1' is always somewhat lower than the supply voltage (and a '0' higher than the 'actual zero'), a logic level will hardly contribute to the supply current for the probe. This implies (figure 2) that a logic level at point Z is scarcely loaded by the supply.

Read out

The logic levels are read out with LEDs. Figure 3 shows how this could be done. TTL- and DTL-ICs can handle the highest currents at an output '0'. It is therefore recommended to have the LED light up at a '0'. To keep the overall power consumption of the probe within reasonable limits, the LED (D₃) of figure 3 draws no more than about 4 mA. This is sufficient to obtain a good optical indication. However, 4 mA is too high a load for some IC outputs. Furthermore, the abovementioned '0' indication is less attractive. Both problems can be solved by adding an inverter to the circuit of figure 3. Figure 4 shows a complete indicator stage, 16 of which are used. In this figure, I is the inverter mentioned. The result of the circuit according to figure 4 is a lower IC loading (about 1.5 mA per connecting pin) and a LED indication at '1'. Owing to the TTL/DTL properties, inverter I (figure 4) also ensures that the LED regards an unconnected pin as a '1'. This is the case, for instance, if a 14-pin IC is tested: the two remaining vacant pins cause their LEDs to light up.

5

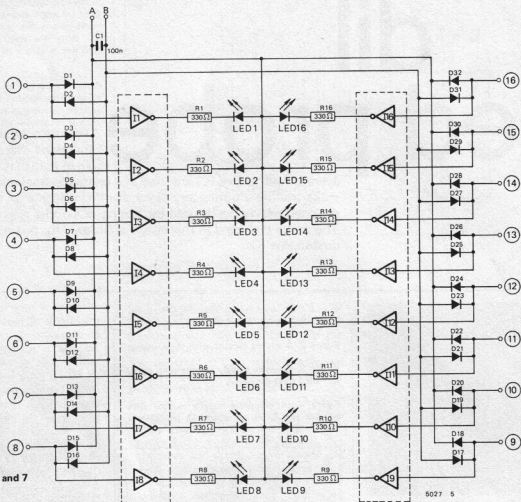

Parts list for figures 5 and 7

R1 R16 = 330Ω
 C1 = 100n, low inductance type
 D1 D32 = DUG (or DUS)
 LED1 LED16 = any type
 IC1, IC2, IC3 = 7405

D1 ... D32 = DUG
 I1, 2, 3, 6, 7, 8 = IC1
 4, 5, 12, 13 = 2/3 IC2
 19, 10, 11, 14, 15, 16 = IC3
 IC1, IC2, IC3 = 7405

6

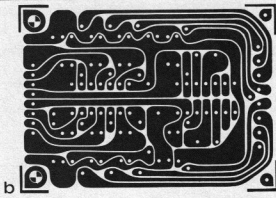
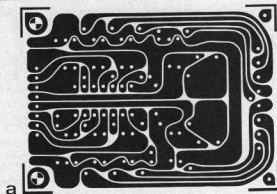

7

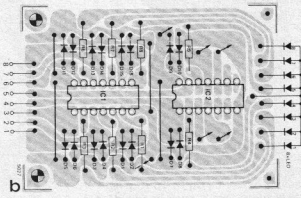
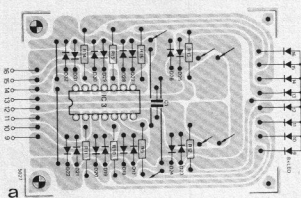

Figure 5. The complete circuit diagram of a digital IC probe.

Figure 6. The lay-outs of the printed circuit boards A and B for the probe.

Figure 7. The boards A and B with the component arrangement for the circuit of figure 5.

Figure 8. Photograph of a complete digiprobe.

8

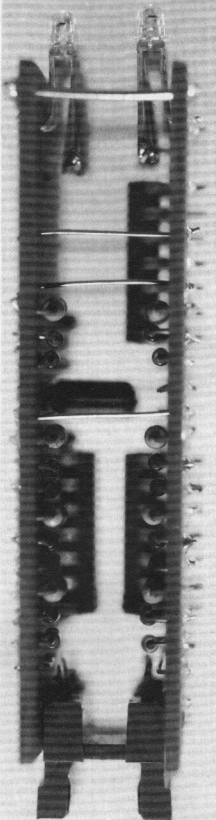

The complete tester

Figure 5 shows the circuit diagram of the complete digital probe. Some 32 diodes ($D_1 \dots D_{32}$) are needed for the voltage probe. For the 16 inverters use is made of three TTL-ICs, type 7405. Each 7405 contains six inverters, so that two inverters remain unused. The encircled codings in figure 5 represent the connecting pins of the IC probe. Points A and B are the supply and common for the three 7405 ICs.

The printed circuit boards

Figure 6 gives the lay-out of the two p.c. boards for the circuit of figure 5. The component arrangements for this circuit are shown in figure 7. Board A carries only one IC. This board accommodates the circuit section for pins 1 ... 8. After assembly the boards are connected back-to-back. This is illustrated in figure 8, showing a photograph of the complete probe. As the figure shows, the p.c. boards are placed with the component sides facing each other. A 16-pin connector is provided between them. The so-called pick-a-back connector shown is made by Electrosil.

As shown in the figure, the anodes of the LEDs are coupled together and connected to points G and G' respectively. The points A ... F on board A are electrically connected with the corresponding points on board B (so: A with A', B with B' ...). If this is done with stiff copper wire, the sandwiched assembly will be fairly sturdy.

The opposing corner holes of the p.c. boards are also joined by means of rigid copper wire. ◀

The missing link

Modifications to
Additions to
Improvements on
Corrections in
Circuits published in Elektor

Tunable aerial amplifier

There is a mistake in the component layout for the PC board (elektor 1, p. 42). One tap of coil L_1 is shown connected to ground, whereas it should be connected to the junction of R_2 and C_2 as shown in the circuit diagram (figure 2), which is the neighbouring pin on the coil former. The PC board itself is correct.

The FETs mentioned in this article are supplied by the following manufacturers: Siliconix: E300, E310, U310, E304; Teledyne: U1994E, 2N4416, 2N5397; Signetics: SD201.

COMING SOON IN ELEKTOR

-FIDO, a new electronic game

-dynamic range compressor

-LED level indicator

-time-lapse cinematography

-TUP/TUN tester

-touch control preamp

-high quality disc preamp for dynamic cartridges

elektor „sonant” loudspeaker system

An earlier article explained the operating principle of the electronic loudspeaker. It was shown that this approach enables a woofer in a relatively small enclosure to provide really good reproduction quality from 40 Hz upwards.

The second step is to describe a complete system, using active crossover networks, based upon the electronic loudspeaker used as a woofer. The system provides unusually good reproduction quality for its modest size and low cost.

An electronic woofer can be designed to have a flat frequency response curve beginning at 40 Hz — or an even lower frequency if desired. This flat response will normally be maintained up to about 400 Hz. Above this frequency it will be necessary to apply additional corrections, which are dependent on the loudspeaker used, the size and shape of the enclosure (and the loudspeaker's position on the front) — and even the position of the enclosure relative to room boundaries.

The simplest design choice would therefore seem to be an application of the electronic loudspeaker to the woofer-range, with reproduction of the mid- and treble ranges by normal units.

Such an approach makes it very desirable to use a separate driving amplifier for the woofer, with crossover networks ahead of this amplifier. The mid- and treble ranges can then be handled by one or two smaller amplifiers, for two- or three-way systems respectively.

Two-way system

The so-called two-way system provides a simple solution which can nonetheless produce excellent results. The block diagram for this is shown in figure 1. The 'crossover' frequency chosen is 340 Hz. The electronic woofer reproduces the range 40-340 Hz, while a separate 10-watt amplifier takes care of the remainder of the frequency range.

Two preset potentiometers, inserted in the circuit ahead of the crossover networks, enable the correct loudness balance to be set up. The adjustment is best done by ear, preferably with the system installed in its working location. In this way the inevitable differences between the efficiencies of the various loudspeaker-drivers used can be equalised.

Care must be taken to connect the two drivers in the correct phase-relationship. The woofer is operated with the 'plus' terminal — the terminal which, when driven positive, causes the cone to move outwards — connected to the 'hot' power-

amplifier terminal. The mid-high-range driver is then connected with its 'plus' terminal to chassis, i.e. the 'wrong way around'. On many loudspeakers the 'plus' terminal is identified by the maker, by means, for example, of a red dot.

Three-way system

The three-way system is built up according to the block diagram given in figure 2. The electronic woofer operates as before, for frequencies up to 340 Hz. A second amplifier handles the range 340 to 4800 Hz., while a third unit operates at frequencies above 4800 Hz. This may seem to be the expensive way of doing things; but in practice the additional lower-power amplifiers often turn out to be less expensive than conventional crossover networks. In any case the results are usually better, while the level-balance between the high- mid- and bass-loudspeakers can be very conveniently obtained by adjustment of the three preset potentiometers.

Once again, attention must be paid to correct relative phasing of the drive-units. This is also shown in the block diagram.

The crossover networks

The crossover networks for the two-way system are built up according to figure 3; the three-way circuit diagram is given in figure 4. The circuits are simple, to the point of being primitive, being cascades of passive RC-networks, buffered by means of emitter-followers. Reliable, stable and predictable. Furthermore the two arrangements are so similar that both can use the same printed circuit board. For the two-way system all that is required is a single printed circuit board, with the component layout shown in figure 6.

The three-way system circuit requires two of the boards. One of these is laid out according to figure 7, for the mid-range and treble channels. The other is laid out according to figure 8, with the circuits for bass reproduction via the electronic loudspeaker. This latter p.c. board also includes an input buffer (T.).

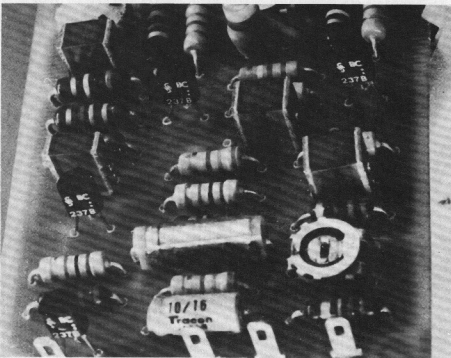

1

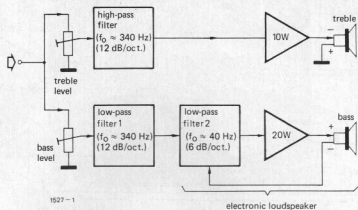

1527-1

Figure 1. Block diagram of the two-way system.

2

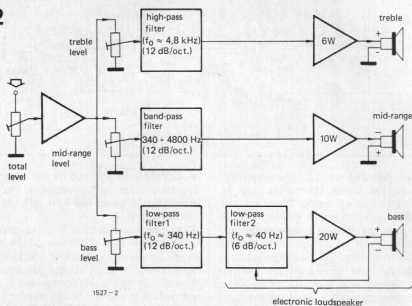

1527-2

Figure 2. Block diagram of the three-way system.

Figure 3. Circuit diagram of the two-way system. The motional feedback in the bass-channel is adjusted by means of P_3 ; the level-adjustment presets P_1 and P_2 enable the correct loudness-balance to be obtained between bass and treble channels.

3

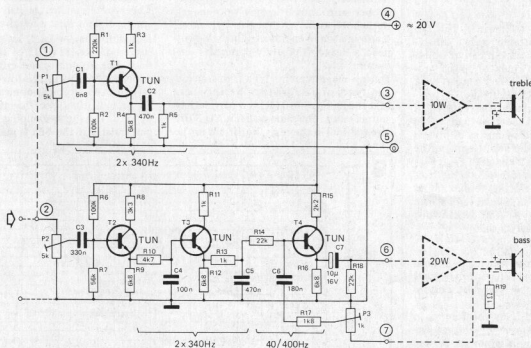

1527-3

Parts list for figures 3 and 6

Resistors:

R1	=	220K
R2, R6	=	100K
R3, R5, R11, R13	=	1K
R4, R9, R12, R16	=	6K8
R7	=	56K
R8	=	3K3
R10	=	4K7
R14, R18	=	22K
R15	=	2K2
R17	=	1K8
R19	=	1 Ω
P1, P2	=	5K (preset)
P3	=	1K (preset)

Capacitors:

C1	=	6n8
C2, C5	=	470n
C3	=	330n
C4	=	100n
C6	=	180n
C7	=	10μ/16V

Transistors T1 to T4: TUN

Parts list for figures 4, 7 and 8

Resistors:

R1, R101, R106	= 220k
R2, R6, R102, R107	= 100k
R3, R4, R9, R12, R16,	
R104, R109, R110,	
R112, R113, R116	= 6k8
R7	= 56k
R8, R108, R111	= 3k3
R10	= 4k7
R11, R13, R103,	
R105, R115, R118	= 1k
R14, R18	= 22k
R15	= 2k2
R17	= 1k8
R19	= 1 Ω
P1	= 50k (preset)
P2, P101, P102	= 5k (preset)
P3	= 1k (preset)

Capacitors:

C1, C3	= 330n
C2, C7	= 10 μ /16V
C4	= 100n
C5, C107	= 470n
C6	= 180n
C101	= 470p
C102	= 33n
C103	= 6n8
C104, C105	= 4n7

Transistors:

T₁ to T₄, T₁₀₁ to T₁₀₄ = TUN

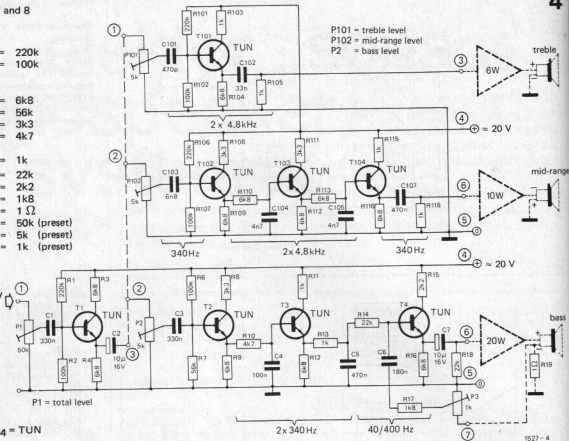

Setting-up procedure

The adjustment of the electronic woofer — in either arrangement — is made by means of the preset potentiometer P₃. This is slowly turned up from zero position to the point at which the system starts to oscillate (howl), and then turned back until oscillation just ceases.

Some loudspeakers have inferior magnetic systems in which the degree of electro-magnetic coupling varies during the drive-coil throw. An adjustment made as above can then give rise to a kind of 'after-pong' effect (if once you hear it you'll know what we mean!). This can be clearly demonstrated with a square-wave input; but of course it can be objectionable on some kinds of music programme. The remedy is very simple: back off a little more on preset P₃.

In the two-way system, the balance of loudness between the bass and treble channels is adjusted by means of presets P₁ and P₂. The same adjustment in the three-way system is made with P₁₀₁, P₁₀₂ and P₂. Turn the preset which controls the least sensitive channel to maximum, then adjust the other(s) until the balance 'sounds right'. It is well worthwhile spending a little time on this.

Choice of components

The components from which this system is built up — the amplifiers, drivers and the enclosure — have to meet certain specific requirements.

The amplifier used with the electronic woofer must be completely and unconditionally stable, even when its output is short-circuited. The prototype systems used the 'Bass amplifier' previously de-

scribed (Elektor no. 1). The amplifiers used in the treble channel(s) may be small high-quality units. They are not normally called upon to deliver as much power as the woofer's drive-amplifier, but they must of course be free from audible distortion. The bass driver should preferably have a high-quality electro-magnetic motor system. This ultimately determines the system performance and the maximum obtainable output. It is also desirable that the cone-suspension be moderately stiff; the supercompliant rubber surrounds on some woofers can misbehave quite seriously at high drive-levels in a small enclosure. One will then need a larger — possibly damped — enclosure.

During measurements on various makes and types of bass drivers it became clear that the Philips 9710 (M) is a particularly suitable unit. The same maker's AD 3701 also did well in the tests, but it has in the

meantime been replaced by the nominally almost identical (according to Philips) AD 7061 M which we have not yet extensively tested.

The treble reproduction in these systems is 'standard' — without use of the electronic loudspeaker principle — so that the drivers have to meet normal hi-fi-requirements. Among the several units that seemed to give good results are the mid-range drivers Kef B 110 and the Philips AD 5060/Sq, along with the 'dome' tweeters Kef T 27 and Heco PCH 24.

The woofer enclosure can be a fairly simple design. What is required is a totally closed box having fairly solid walls — we suggest chipboard of 15 or 18 mm thickness. The volume is not critical since it really only affects the low-end power-response. For typical domestic listening 15 litres is usually sufficient (e.g. 12" x 9" x 8"). A little damping is desirable, particularly if the box is made consider-

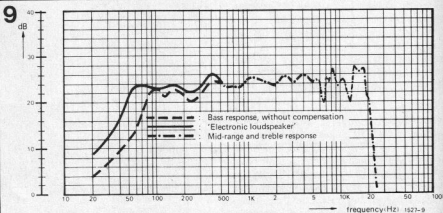

5

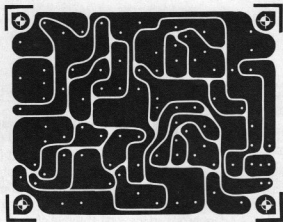

6

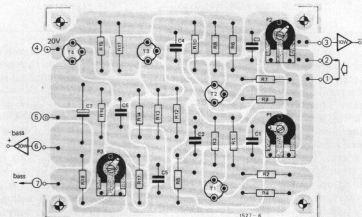

7

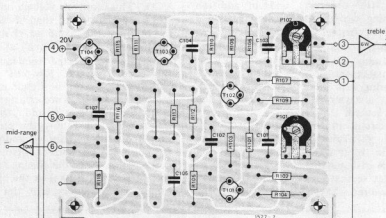

8

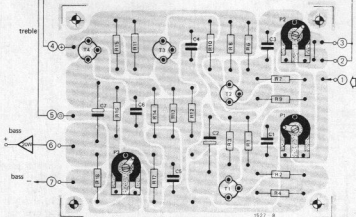

Figure 4. Circuit diagram of the three-way system. P_3 is once again used to correctly set up the bass-channel motional feedback; loudness-balancing is done by adjusting P_2 , P_{101} and P_{102} . P_1 provides an additional total-level adjustment, which can be convenient when setting up a stereo pair.

Figure 5. The universal printed circuit layout for all filter circuits.

Figure 6. Components layout for the single p.c. board used with the two-way system according to figure 3.

Figure 7. Component layout for the mid-range and tweeter channels of the three-way system (figure 4).

Figure 8. Component layout for the bass-channel and buffer stage as used in the circuit of figure 4.

Figure 9. Result of measurements (total radiated power) on a typical three-way system.

ably larger than 15 litres. This will usually arise if one wants an extended power-response. Damping may in any case be needed with drivers having limited magnetflux (to help eliminate the 'after-pong' effect). A 20 mm thick pad of glasswool, mounted by means of laths at a random angle through the centre of the enclosed volume – not parallel or close to the walls – will do the trick.

Conclusion

Application of the electronic loudspeaker-compensation described here – actually a form of 'motional feedback' – can enable excellent results to be obtained with a relatively small woofer-enclosure. The curves in figure 9 are the results of measurements made on a typical system, with and without the compensation operative.

The only real objection to this approach is the fact that it requires fairly critical adjustment for best results. This difficulty would be considerably lessened if a bass-driver fitted with a properly-designed and reliable feedback-transducer were to become generally available. The transducer could deliver a signal proportional to the cone's displacement, to its velocity, or – preferably – to its acceleration. One recently-introduced commercial system (Philips) is designed around just such a woofer-accelerometer combination.

As a final remark we note that a loudspeaker operating with motional feedback forms part of a control-loop which includes the power amplifier. It is obviously desirable to install this amplifier in the loudspeaker cabinet, or the fact that the feedback signal is carried by the same leads which deliver the drive power means that the system will require re-adjustment every time the lead length is changed!

tv sound

For those who are dissatisfied with the quality of their television sound (and who isn't?)

here is a design which enables a high-quality sound signal to be derived from a television receiver and fed into a separate amplifier and speaker system without making any connection to the T.V. set; a procedure which can be highly dangerous in view of the live-chassis construction employed in the manufacture of television receivers.

Television Sound, bad or indifferent, but hardly ever good

Many people possess audio equipment of at least moderate quality from which they expect to obtain good sound with discs, tape or F.M. tuners, but even audiophiles frequently put up with mediocre noises from the 'idiot's lantern'. This is a pity as T.V. producers nowadays tend to give much more thought to the artistic quality and suitability of music which is part of a T.V. programme. In fact, even the 'leitmotif' to some T.V. series are so popular that they are released on records.

People who appreciate high quality sound but who do not have a technical background (this includes many newspaper programme critics) tend to place the blame for poor quality sound on the shoulders of the BBC or IBA. This is most unfair as the quality of the sound leaving the studio is generally fairly high. The blame lies with the manufacturers of T.V. sets who skimp on the audio side of their products in the interests of economy and compactness. They can get away with this because the ear will tolerate poor sound quality much more than the eye will tolerate defects in the

picture. The audio amplifiers in T.V. sets are generally of low power and poor performance. In addition it is difficult to put a good-quality loudspeaker into a television cabinet because a) there is insufficient space (except in large floor-standing models) and b) good loudspeakers generally have powerful magnets which tend to upset television tubes, especially colour ones.

One solution to the problem of poor T.V. sound would be to have a separate U.H.F. tuner coupled to a Hi-Fi system, and there are such tuners on the market. This would, however, duplicate a part of the T.V. set which does its job perfectly well (bad T.V. sound invariably starts after the detector) and in addition retuning would be necessary whenever the T.V. channel was changed.

Another possibility would be to extract the audio signal after the detector via an isolating transformer, but this involves tinkering with the T.V. circuitry, which is not always possible, especially if the set is rented.

The circuit to be described avoids all these difficulties by extracting the 6 MHz intercarrier sound signal by means of a pickup coil on the back of the set so that no electrical connection is required. The circuit picks up the

sound signal for whatever channel the T.V. is tuned to, so that no retuning is required when the channel is changed.

Principle of Operation

In figure 1 the signal from the pickup coil is amplified and filtered with a passband of 300 kHz. This filtered intercarrier signal is fed to one of the inputs of the phase comparator IC1. The other input comes from a voltage-controlled oscillator (VCO). The output voltage of the phase comparator is proportional to the phase difference between its two inputs. This output is fed through a low-pass filter to the control input of the VCO. This control voltage alters the VCO frequency so that it tends to become the same as that of the intercarrier signal. When a VCO is 'locked-in' to a fixed-frequency signal the output of the low-pass filter is constant. However, the frequency of the intercarrier signal is not constant as it is frequency-modulated and the VCO frequency must follow the changes in frequency to remain locked-in. This means that the VCO control voltage must change. Since the change in control voltage is proportional to the change in frequency it follows that the changes

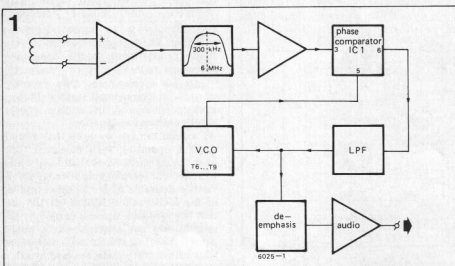
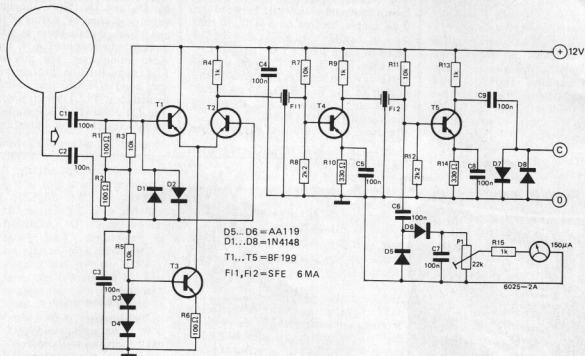

Table Performance Data

Signal-to-noise ratio (Audio signal produced by 160 μ V intercarrier signal with \pm 40 kHz deviation at 1 kHz versus R.M.S. noise level with no input) - greater than 52 dB	
PLL capture range - 4 MHz	
Supply voltage - 12 V \pm 2 V	
Supply current - 20 mA	
85% amplitude-modulated	- greater than 40 dB

2a



2b

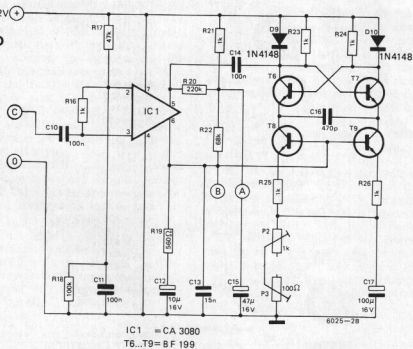

Figure 1. Block diagram of the television sound unit. The phase comparator, low pass filter and VCO form a phase-locked loop (PLL) F.M. detector.

Figure 2. Complete circuit of the television sound unit.

in control voltage are the audio signal which modulated the intercarrier signal. This phase-locked loop system thus demodulates the 6 MHz intercarrier signal and all that remains is to de-emphasise and amplify it.

Circuit Details

The complete circuit, including the power supply, is mounted on a single printed circuit board. The only external connections (apart from the mains lead) are the connections to the pickup coil and the audio output.

Figure 2 shows the complete circuit.

2c

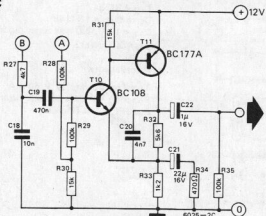

2d

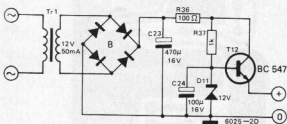

The pickup coil leads are connected via isolating capacitors C_1 and C_2 to the inputs of the differential amplifier T_1 and T_2 . This means that common-mode signals such as mains are largely eliminated and only signals induced in the coil will be amplified. Diodes D_1 and D_2 clip any high-voltage transients which might damage T_1 and T_2 . T_3 , D_3 and D_4 form a constant-current source for the differential pair.

The ceramic filters F_{11} and F_{12} each have a passband of 300 kHz between the 3 dB points, centred on 6 MHz, so that two in cascade, with T_4 as a buffer between them have a 6 dB passband of 300 kHz. D_5 , D_6 and C_7 form a peak-detector which rectifies the signal on the output of F_{12} to drive a 150 μ A meter to indicate the signal strength. P_1 adjusts the sensitivity of this meter.

The signal at the output of F_{12} is further

amplified by T_5 and is then clamped by D_7 and D_8 . Since the intercarrier signal is derived by mixing of the sound and vision signals there is a very high level of superimposed A.M. due to the video modulation. For this reason the F.M. demodulation process must have very good A.M. rejection and so a phase-locked loop (PLL) system was chosen.

The CA 3080 (IC₁) is described by the manufacturers as an operational trans-

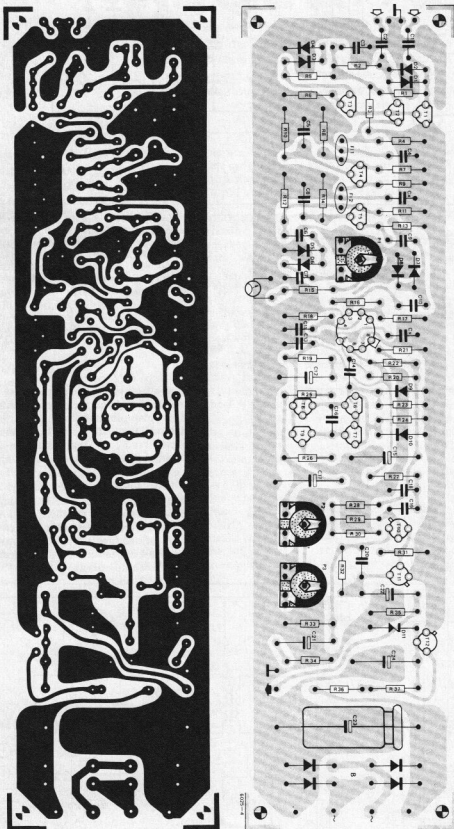

Components List:

Resistors:

$R_1, R_2, R_6, R_{36} = 100 \Omega$
 $R_3, R_5, R_7, R_{11} = 10 \text{ k}$
 $R_4, R_9, R_{13}, R_{15}, R_{16},$
 $R_{21}, R_{23} \text{ to } R_{26}, R_{37} = 1 \text{ k}$
 $R_{18}, R_{28}, R_{29}, R_{35} = 100 \text{ k}$
 $R_{30}, R_{31} = 15 \text{ k}$
 $R_8, R_{12} = 2 \text{ k}$
 $R_{10}, R_{14} = 330 \Omega$
 $R_{17} = 47 \text{ k}$
 $R_{19} = 560 \Omega$
 $R_{20} = 220 \text{ k}$
 $R_{22} = 68 \text{ k}$
 $R_{27} = 4 \text{ k}$
 $R_{32} = 5 \text{ k}$
 $R_{33} = 1 \text{ k}$
 $R_{34} = 470 \Omega$

Capacitors:

$C_1 \text{ to } C_{11}, C_{14} = 100 \text{ n}$
 $C_{12} = 10 \mu/16 \text{ V}$
 $C_{13} = 15 \text{ n}$
 $C_{15} = 47 \mu/16 \text{ V}$
 $C_{16} = 470 \text{ p}$
 $C_{17} = 100 \mu/6.3 \text{ V}$
 $C_{18} = 10 \text{ n}$
 $C_{19} = 470 \text{ n}$
 $C_{20} = 4 \text{ n}$
 $C_{21} = 22 \mu/6.3 \text{ V}$
 $C_{22} = 1 \mu/16 \text{ V}$
 $C_{23} = 470 \mu/25 \text{ V}$
 $C_{24} = 100 \mu/16 \text{ V}$

Semiconductors:

IC₁ = CA 3080 (RCA)
 $T_1 \text{ to } T_9 = \text{BF } 199$
 $T_{10} = \text{BC } 108$
 $T_{11} = \text{BC } 177 \text{ A}$
 $T_{12} = \text{BC } 547$
 $D_1 \text{ to } D_{10} = 1\text{N}4148$
 $D_{11} = 12 \text{ V}/400 \text{ mW zener diode}$
 $B = 4 \times 1\text{N}4002$

Miscellaneous:

Tr = Transformer 12 V/50 mA
 $FL_1, FL_2 = 6 \text{ MHz ceramic filters,}$
 e.g. SFE 6 MA (Murata)

conductance amplifier (try saying that after a few pints) and is used here as an asymmetrical phase comparator. Its significant feature is that the gain can be changed by altering the current into pin 5, the relationship being linear.

T_6 and T_7 form an astable multivibrator. Diodes D_9 and D_{10} limit the collector swing of these transistors to about 0.7 V so the multivibrator will run at higher frequencies than it could if larger swings were allowed. The running frequency of the multivibrator can be controlled by the current into the commoned bases of T_8 and T_9 . (So this is really a current controlled oscillator but we call it a VCO for consistency.) Coarse and fine preset adjustment of frequency is provided by P_2 and P_3 respectively in the common emitter bias circuit of T_8 and T_9 . A current feed into pin 5 of IC_1 is derived from the collector of T_6 . The clipped intercarrier signal is fed into one of the differential inputs of IC_1 (pin 3) whilst the other input is grounded to signal via C_{11} . Since the gain of IC_1 is proportional to the output voltage of the VCO it is clear that the intercarrier signal and the VCO are being multiplied together and the output current of IC_1 varies according to the relative phase of these two inputs. The output current of the IC is taken through a low-pass network and this filtered output controls the frequency of the VCO by injecting current into the bases of T_8 and T_9 . The sense of the control current is such that it always tries to keep the VCO in phase with the intercarrier signal. The control current therefore follows the variations in frequency of the intercarrier signal due to the audio modulation. The audio signal which thus appears on the control input of the VCO is de-emphasised by R_{27} and C_{19} and is amplified by T_{10} and T_{11} .

The simple power supply circuit is also shown in figure 2. It consists simply of a transformer, bridge rectifier and smoothing capacitor and an emitter-follower stabiliser with zener diode D_{11} as voltage reference. C_{24} suppresses noise from D_{11} .

Construction and Alignment

The construction of the p.c. board is straightforward and requires no further comment. The construction of the pickup coil is shown in figure 3. The dimensions given should be adhered to as the coil inductance and lead capacitance are designed to be broadly resonant around 6 MHz. Single-strand 22 SWG plastic-covered wire should be used for the coil and the twin connecting lead should be made up of two lengths of screened audio lead with an outside diameter of 3 mm. and polythene dielectric. The leads are shown separated in a) to make the connections to the screens clear, but they should actually be touching, as in b).

To align the circuit, connect the T.V. sound unit to the mains and check that all the D.C. voltage levels are correct. Connect up the pickup coil and connect the audio output to a suitable amplifier. Turn the slider of P_1 to maximum. Tune the T.V. set to a convenient programme and search over the back of the set with the pickup coil until the meter shows a deflection and position the coil for maximum deflection. If the meter goes off the scale turn down P_1 . Adjust P_2 and P_3 until the VCO locks in and a sound signal can be heard. If no sound results it is possible that unwanted pickup is coming from the line output transformer, so reposition the pickup coil and try again. When a sound signal has been obtained move the pickup coil around until the background noise is a minimum. This is not necessarily the position which gives maximum deflection on the meter. It now remains to set the VCO free-running frequency to 6 MHz so that it is near the middle of its 'capture' range. That is to say the frequency at which the VCO tunes when it is not receiving an intercarrier signal should be around 6 MHz. If it is too far away from this frequency the system may fail to lock-in when next switched on without being adjusted, since at the first trial it may have been within its 'hold' range, but outside its 'capture' range, which is narrower.

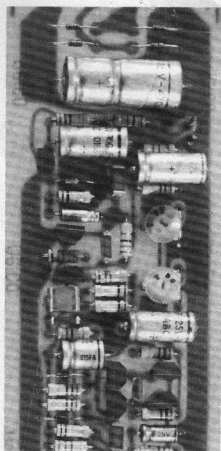

Proceed as follows. Having found the optimum pickup coil position on the back of the T.V. set move the coil away from the set until the signal disappears. Move the coil back towards the set and check that the sound reappears. It should be possible to adjust P_2 and P_3 so that the signal reappears whilst the coil is still a few cm. from the back of the set and this is satisfactory. One fault which the T.V. sound unit will not cure is 'buzz' due to captions, subtitles and other high contrast areas of the picture. Some alleviation of this may be obtained by retuning the set. The problem may be due to overloading at the r.f. input in which case an attenuator in the aerial downlead may effect a cure. ■

3

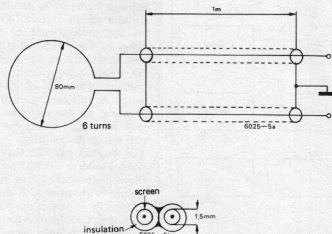

Figure 3. Details of the pickup coil. These dimensions should be adhered to for best results.

three-eyed bandit

From time immemorial man has played games of chance. In primitive societies the men often sat around throwing dice or playing other games while the women did the work. Nowadays, alas, this situation no longer exists, but modern technology has considerably widened the scope of games of chance so that a whole range of 'gaming machines' can be seen today.

The most common type of mechanical or electromechanical gaming machine is the 'one-armed bandit' or 'fruit machine'. In such machines three cylinders bearing numerals or symbols are set into rotation simultaneously by pulling a handle or pressing a button. The cylinders ultimately stop or can sometimes be stopped by the player and the combi-

nation of symbols appearing in a window when the cylinders have stopped determines whether a win has occurred and the magnitude of that win. The less probable combinations are, of course, awarded the higher prizes.

The 'Three-eyed bandit' described here works on the same principles but is completely electronic. Instead of mech-

anical drums there is a display of three columns of four lamps. When a start button is pressed the three columns of lamps flash until individually stopped by three stop buttons. A win is indicated when a row of three lamps is lit and the magnitude of the win depends on which row is lit.

Referring to figures 1 and 2 the system

Table 1

COUNT	D	C	B	A	L ₁	L ₂	L ₃	L ₄	LAMP LIT
0	0	0	0	0	0	0	0	1	L ₄
1	0	0	0	1	0	0	1	0	L ₃
2	0	0	1	0	0	1	0	0	L ₂
3	0	0	1	1	1	0	0	0	L ₁
4	0	1	0	0	0	0	0	1	L ₄
5	0	1	0	1	0	0	1	0	L ₃
6	0	1	1	0	0	1	0	0	L ₂
7	0	1	1	1	0	0	0	1	L ₄
8	1	0	0	0	0	0	0	1	L ₄
9	1	0	0	1	0	0	1	0	L ₃

Table 1. The truth table for the lamp decoding. The Boolean functions for the four lamps in a column are as follows: (referred to the BCD outputs of the 7490)

$$L_1 = A \cdot B \cdot \bar{C} \quad L_3 = A \cdot \bar{B}$$

$$L_2 = \bar{A} \cdot B \quad L_4 = A \cdot B \cdot C + \bar{A} \cdot \bar{B}$$

Figure 1. Suggested front panel layout for the Three-eyed Bandit.

Figure 2. Block diagram of the Three-eyed Bandit.

Figure 3. The complete circuit of the Three-eyed Bandit.

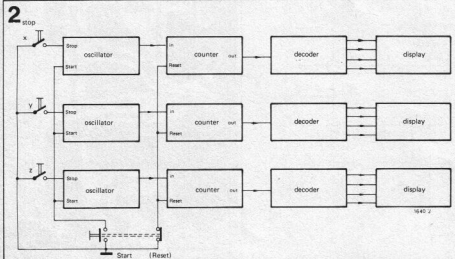
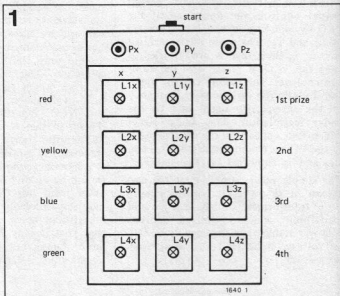

operates as follows. Each column of lamps is driven by an oscillator, a decade counter and a decoder. The oscillators are independent and of different frequencies. The three oscillators are started simultaneously by the start button and are stopped individually by three stop buttons. The rate of flashing of the lamps is sufficiently high so that no cheating can occur when pressing the stop buttons. Pressing the start button also resets the counters.

The weighting of the various combinations is achieved as follows. Referring to the column marked X in figure 1 the decoding is arranged such that L4X lights 4 times in a cycle of ten pulses from the oscillator, L3X lights 3 times, L2X lights twice and L1X lights once. The decoding is mutually exclusive, that is only one

lamp is lit at any time. It is therefore obvious that when the stop button is pressed it is most probable that L4X will be alight and least probable that L1X will be lit. The respective probabilities are:

$$\begin{aligned} P_{L4} &= 4/10 \\ P_{L3} &= 3/10 \\ P_{L2} &= 2/10 \\ P_{L1} &= 1/10 \end{aligned}$$

This is true for all three columns of lamps. The probability of all three lamps in a row being lit simultaneously is given by the product of the individual probabilities thus:

$$\begin{aligned} P(\text{row } 1) &= P_{L1X} \cdot P_{L1Y} \cdot P_{L1Z} \\ &= 1/10 \cdot 1/10 \cdot 1/10 \\ &= 1/1000 \end{aligned}$$

Similarly

$$\begin{aligned} P(\text{row } 2) &= 2/10 \cdot 2/10 \cdot 2/10 = 1/125 \\ P(\text{row } 3) &= 3/10 \cdot 3/10 \cdot 3/10 = 1/37 \\ P(\text{row } 4) &= 4/10 \cdot 4/10 \cdot 4/10 = 1/16 \end{aligned}$$

Since the probabilities of all the lamps in row 1 being lit is the smallest row 1 obtains the highest prize. Of course a win need not be awarded just on a complete row. Wins could be awarded for part rows as in a mechanical one-armed bandit where a prize might be awarded for two 'oranges' in a row. All that is needed is to calculate the probabilities of a particular

combination and award prizes or points such that the lower the probability the larger the prize.

The operation of the circuit is as follows. Only column 1 will be described as the others are identical. In figure 3 N_3 and N_4 form an astable multivibrator. N_1 and N_2 form a set-reset flip-flop. When the flip-flop is reset by P_X the output of N_1 is low. Pin 10 and pin 12 of N_3 and N_4 respectively are held low, the outputs are thus high so the astable will not start. When the start button is pressed the flip-flop is set and the astable starts, thus driving the 7490 decade counter until the stop button P_X is pressed. The output of the counter is decoded in accordance with the truth table of table 1. Note that a '1' under a lamp number indicates that the lamp is lit. Note also that the lamp driver transistors $T_2 - T_4$ are NPN, whereas T_1 is PNP. Therefore when a '1' appears at the output of N_{13} L_1 will go out, whereas when a '1' appears at the output of N_{12} for instance, L_2 will light. T_1 thus inverts the output of N_{13} as far as lighting the lamp is concerned.

Warning: This Three-eyed bandit is intended for private amusement only. There are very strict laws in the U.K. governing the use of gaming machines for money and other prizes in clubs, public-houses &c. - Ed.

big ben 95

Nowadays both mechanical and electronic doorbells playing complete melodies are commercially available. The Big Ben plays a striking and well-known melody.

Figure 1 shows the circuit diagram of this Big Ben. When bell button Dr_1 is depressed, RS flip-flop N_6, N_7 is set. The pulse on the output of N_7 changing from '1' to '0' is passed on via C_7 to a second RS flip-flop N_3, N_4 . Consequently a logical '1' appears at the serial input of IC_1 . This '1' is shifted onwards at the first clock pulse and arrives at the A output of IC_1 . The result is that RS flip-flop N_3, N_4 is reset via N_5 . Now the serial input is '0' again. The '1' fed into the shift register now moves forward through shift registers $IC_1 \dots IC_3$ at the frequency of the clock pulse.

After 12 clock pulses the D output of IC_3 will become '1'. Via N_8 this '1' resets RS flip-flop N_6, N_7 , so that the circuit returns to its steady state.

The clock pulses are obtained from an astable multivibrator comprising N_1 and N_2 which oscillates continuously. The frequency (tempo of the Big Ben melody) can be adjusted to personal taste by means of C_5 and C_6 .

The output voltages of shift registers $IC_1 \dots IC_3$ are supplied to a voltage-controlled oscillator T_1, T_2 via the trimming potentiometers $P_1 \dots P_{12}$ and $D_1 \dots D_{12}$.

If so desired, P_5, P_{10}, D_5 and D_{10} may be omitted to obtain the required rests in the Big Ben melody.

Potentiometers $P_1 \dots P_{12}$ govern the frequencies of the voltage-controlled oscillator T_1, T_2 .

To prevent this oscillator from oscillating if none of the shift-register outputs is '1' (in its steady state), capacitors C_3 and C_4 are included in the circuit.

The oscillation signal of the voltage-controlled oscillator is applied to a loud-speaker via T_3 . As the latter only switches, it does not dissipate much power, so that no additional cooling is required. Figures 2 and 3 show the layout and arrangement of the components on the print. The potentiometers are conveniently arranged, so that final trimming to obtain the correct melody is an easy job.

3

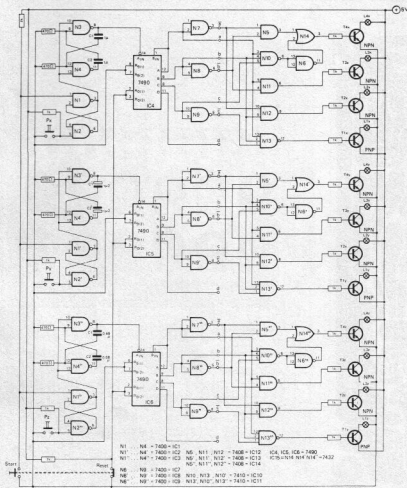

1

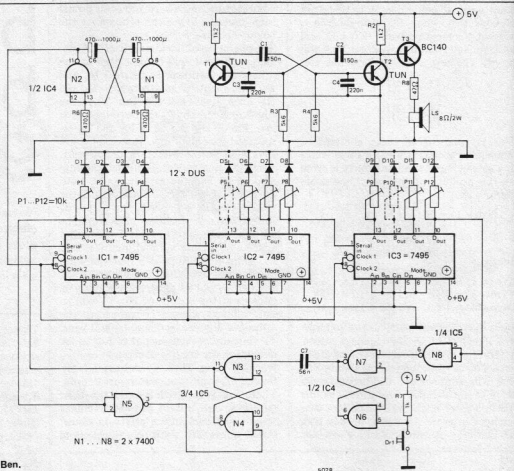

2

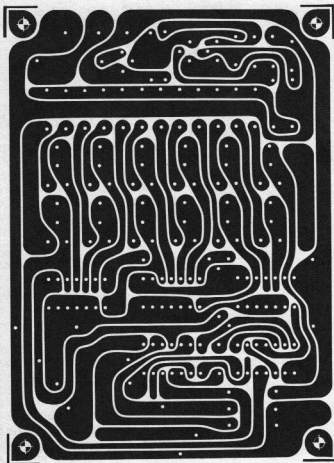
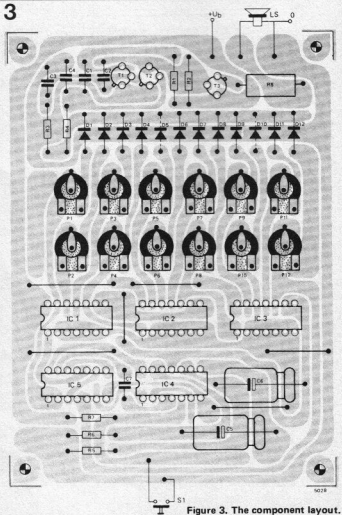

Figure 2. The p.c. board for figure 1.

3



COS/MOS digital ICs

COS/MOS is a development of bipolar IC technology and an offspring of the MOS (Metal Oxide Semiconductor).

It started with the MOSFET being developed from the universally known junction FET (Field Effect Transistor). The former distinguish themselves from the latter by their isolated gate. The result of this gate isolation is a particularly high gate resistance. A drawback is that a static charge can build up on such a gate when the transistor is not connected in a circuit. This charge usually causes the immediate destruction of a MOSFET because the extremely thin isolating layer breaks down. So the handling of MOSFETs calls for special precautions. This also applies to COS/MOS ICs in which MOSFETs are integrated.

The integration is such that P+ and N-channel transistors are used alternately. Furthermore the switching circuits are integrated symmetrically. The latter two characteristics form the basis for the term COS (Complementary Symmetry). Thus COS/MOS can be briefly described as complementary symmetrical MOSFET integration. A simple example of a COS/MOS IC construction is given in figure A. Here the dark-shaded area represents the n- (polarized) substrate. The diagonally-hatched area is the metal oxide film on which the electrical contacts are made. These contacts are drawn in deep black. Below the isolating layer at the electrical contact interruptions are the p- and n- layers. The layers are so integrated that the result is a complementary MOSFET pair as shown in figure B. Corresponding to the labelling of figure A, we have the following labelling in figure B: 'S' for sources, 'G' for gates and 'D' for common drain.

As can be seen from figure A the integration of an N-channel MOSFET is of a simpler construction than a P-channel. The latter requires an extra p-layer separating the substrate from the two n-layers which lie between the drain and G2 (= gate 2) and the junction between G2 and S2 (= source 2), respectively.

Of course, the integration of even the simplest COS/MOS IC is slightly more complex than figure B suggests. Even a common 2-input NAND gate consists of no less than four integrated MOSFETs.

Like MOSFETs, every COS/MOS IC must be handled with due care because the inputs (gates) are isolated with respect to the rest of the integrated

circuit. Normally the input impedance of a gate is $10^{12} \Omega$. As a result a static charge can easily build up if such an IC is kept in a plastic box, for instance. The human body too, is often statically charged. Touching the inputs with a finger can be sufficient to destroy the COS/MOS IC. Therefore the ICs are packed in a kind of expanded plastic containing a highly conductive substance. The connecting pins of the IC are pressed into the expanded plastic. To give the inputs some measure of protection, manufacturers often provide COS/MOS IC inputs with an inbuilt protection circuit. These circuits are not shown in the circuit diagrams of the ICs.

Figure C is an example of an input circuit of a COS/MOS inverter. As can be seen in this figure, the circuit consists of a P- and an N-channel MOSFET. In reality the input circuit is as shown in figure D. Here we see that each gate input protection circuit comprises one resistor and three diodes. The diodes D₄ to D₈ are usually formed in the diffusion process. The gate input protection, however, is added as an extra (a resistor of about 500Ω plus three diodes).

In figure D the diode D₃ has a breakdown voltage of about 25 V. The breakdown voltage of the diodes D₁ and D₂ is about 50 V.

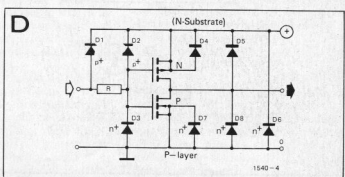
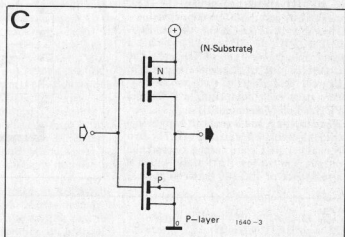
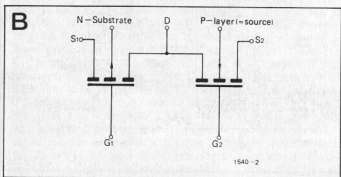
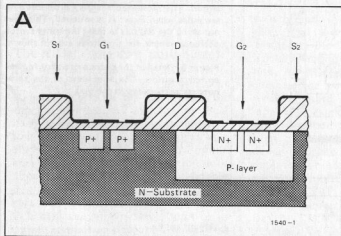

MOS TAP

Solid state circuits are increasingly intruding into fields that were once the domain of electromechanical components, but only recently has it become possible economically to replace the simple electromechanical switch by an electronic system with no moving parts — the Touch Activated Programmer (TAP). In last month's issue a TAP was described which utilised TTL IC's. This month we publish a new design based on COSMOS logic packages.

In line with the Elektor policy of continuous development and utilisation of new technologies a TAP has been developed which uses COSMOS IC's. As will be explained later in the text this offers greater circuit simplicity than the TTL TAP but, since COSMOS prices are higher, this circuit is more expensive than the TTL TAP. Readers thus have two designs from which to choose; a TTL TAP using cheap, readily obtainable components, or a MOS TAP using 'state-of-the-art' devices at slightly higher cost. The main advantages offered by the MOS TAP are as follows:

- micropower quiescent operation.
- excellent noise immunity (typically 45% of the supply voltage).
- wide supply voltage tolerance (3–15 V).
- high input impedance (typically $10^{12}\Omega$) therefore, unlike the TTL TAP, no input buffers are needed.

The MOS TAP is based on an RCA COSMOS IC, the CD4011AE, which is a quadruple two-input NAND-gate. The circuit of one of the gates is given in figure 1. It consists of two complementary pairs each comprising a P-channel FET and an N-channel FET.

When inputs A and B are both high (+V_b) the P-channel FET's are cut off. The two N-channel FET's are turned on and the output is in the low or '0' state, which is a resistance of 400-800 between point C

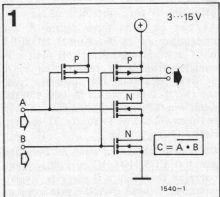

Figure 1. The circuit of one of the NAND-gates in a CD4011AE. Note the use of complementary pairs of P- and N-channel MOSFET's.

Figure 2. The pinout of the CD4011AE DIL package. The configuration is different from the 7400 used in the TTL TAP.

Figure 3. The 'push-button' is the simplest application of a COSMOS NAND-gate as a touch-switch. If points A and B are bridged by a finger the output of the gate will become '1'. If the contacts are released the output becomes '0' again. T₁ is an emitter-follower to increase the output current capability.

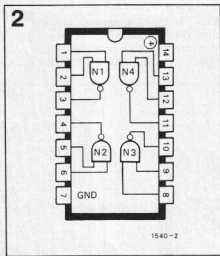
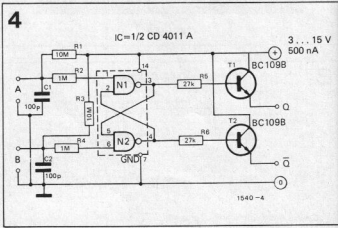
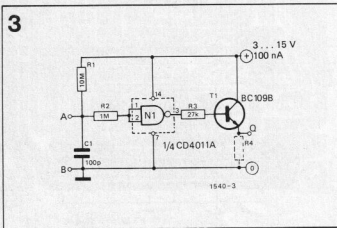
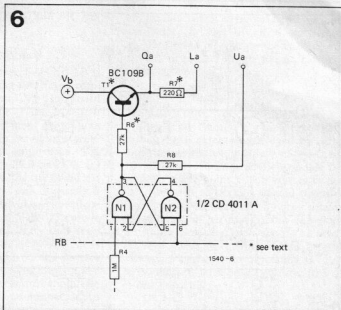
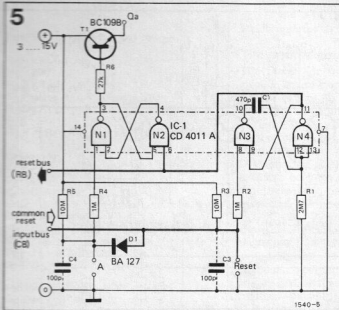

Figure 4. The basic element of the multi-position switch is a set-reset flip-flop. It is shown here with two sets of touch contacts, but one of these is replaced by the reset bus RB in the final circuit.

Figure 5. The basic configuration of the reset circuit. The monostable N₃/N₄ produces a reset pulse when input A is touched. This goes out along the RB bus to reset the other switch positions, which, for simplicity are not shown.

Figure 6. Detail of the output circuitry for one switch position. The functions of the three outputs are detailed in the text.





and supply common. When one or both inputs are low the corresponding P-channel FET is turned on and the N-channel FET is turned off. +V_b therefore appears at output C via the on resistance of the P-channel FET.

The pinout of the CD4011AE is given in figure 2. Note that it is not the same as the pinout of the 7400 which was used in the TTL TAP. The IC is also available in a (more expensive) ceramic package as the CD4011AD. This has the same pinout as the plastic-packaged CD4011AE. For those who are unfamiliar with MOS devices it is worth noting that since the devices are of insulated-gate construction they should be handled with care as static charges can easily destroy the device. In particular it is recommended that an IC socket be used, neither should the device be plugged into nor removed from the circuit with power applied.

The NAND-gate as a 'push-button'

The basic principle of the MOS TAP is illustrated in figure 3. In the quiescent state the inputs of the gate (which for this example are tied together) are held at +V_b by R₁. The output is therefore low. If points A and B are bridged by a finger the input will be held low by the skin resistance, which is a maximum of about 2MΩ for dry skin and considerably less for moist skin. The output of the gate will therefore become high. Since COSMOS can supply only 500μA or so output current an output buffer may be required for some applications. The emitter follower T₁ provides this. If the output is required to sink current in the '0' state R₄ must be included. R₂ is an input protection resistor for the IC and C₁ helps improve the transient noise immunity.

This simple circuit is, of course, useless if latching operation is required so, like the TTL TAP, the MOS TAP is based on set-reset flip-flops. One flip-flop is employed for each switch position and the circuit of one such flip-flop is given in figure 4. It operates in the following

manner. In the quiescent state the inputs (pin 1 and pin 6) are held high by R₁ and R₄. Suppose pin 4 is initially high, then pin 2 is also high. In accordance with the NAND-function pin 3 is low, which means that pin 5 is also low. Pin 4 is therefore high which was our original premise. This is one of the two stable states of the flip-flop. Suppose now that input A is touched. This means that pin 1 is held low. Pin 3 therefore becomes high, and since 6 and 5 are high 4 becomes low. This holds pin 2 low so that even when the touch contact is released the circuit remains in this state. If input B is now touched the circuit reverts to its original state. We thus have a two-position switch.

Extension to multi-position switch

There are various ways of extending the system. One way would be to use NAND-gates with several inputs to make an 'n-stable' flip-flop. One NAND-gate would be required for each switch position. In practice this would be very cumbersome since an n-position switch would require NAND-gates with n+1 inputs. It would also be impossible to further extend the system once it had been built, and of course a different design of printed circuit board would be required for each different number of positions required.

The MOS TAP described in this article uses the same system as that described for the TTL TAP. The switch may be extended to any number of positions using the set-reset flip-flop previously described and the latching operates by using a common reset monostable so that when any contact is touched a reset pulse is produced which cancels all the other switch positions.

The principle of operation of the reset circuit is illustrated in figure 5, which shows one switch position plus the reset monostable. When input A is touched the monostable consisting of N₃ and N₄ is triggered and produces a reset pulse of about 50 mSec. which goes out along the reset bus RB to reset any positions

that are set. CB is the common reset input bus and the switch inputs are connected to it via diodes (D₁) to isolate them from one another. The reset input connected to R₂ directly is the total reset input which may be used to reset all the switch positions if desired.

The output circuitry

Before describing the circuitry of the complete TAP it is necessary to clarify some points concerning the output circuits. As can be seen from figure 6 only the Q output of the flip-flop is used. T₁ is a buffer emitter follower, as described earlier. When the flip-flop is in the reset state T₁ is cut off; when the flip-flop is set, however, a voltage of +V_b-0.7 V. appears at the Q_a output (0.7 V. is the base emitter voltage drop of T₁). The current which T₁ can supply is limited by R₆ and depending on the gain of T₁ can be between 100 and 200 mA; the Q_a output is thus short-circuit proof. The optimum value of R₆ is given by:

$$R_6 = 2 \times 10^3 \times V_b$$

where R₆ is in ohms and V_b in volts. The total current which can be supplied by outputs Q_a and L_a together is approximately:

$$I_{Qa} + I_{La} = 5 \times 10^{-1} \times hFE_{T1}$$

The current is in milliamps. hFE_{T1} is the common-collector current gain of T₁. Output L_a is intended to drive a LED (or lamp) to indicate when a particular switch position is energised. For a typical LED with a voltage drop of about 1.5 V. at 40 mA. R₇ is given by:

$$R_7 = \frac{V_b - 2}{4 \times 10^{-2}}$$

Since the base-emitter voltage of T₁ will vary with temperature output U_a is provided for applications requiring a stable output voltage (the output voltage of U_a is equal to V_b so if the supply is stable output U_a will be). Of course this output can only supply about 500 μA.

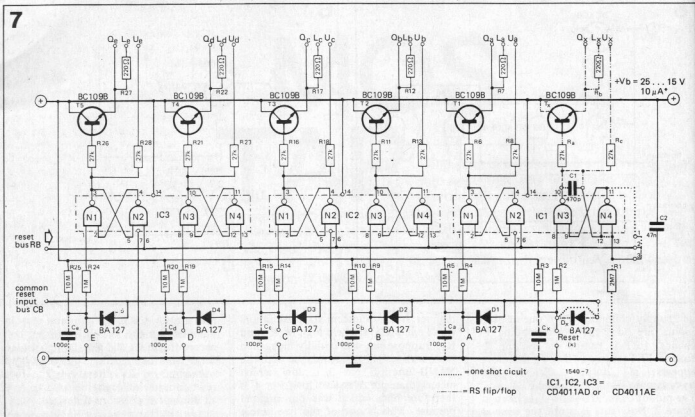

The complete MOS TAP

The circuit of the complete five-position MOS TAP is given in figure 7. As can be seen from the circuit each input is connected to the common reset input bus CB via a diode ($D_1 - D_5$). These isolate the inputs from one another. N_3 and N_4 are the reset monostable.

The system may be extended simply by adding extra boards. In this case, since

only one reset monostable is required for the entire system, N_3 and N_4 on the additional boards may be converted to extra switch positions by adding the components shown in the dot-dash lines, i.e. D_X , T_X , R_A , R_B , R_C . The components shown in dotted lines (i.e. R_1 , C_1 and the links across D_X and pins 11 of the IC and pins 1 and 2 of the board) are omitted. Note the new link between

Figure 7. The circuit of the complete MOS TAP. This has five switch positions, but if the system is extended the monostable on additional boards can be converted to a flip-flop, thus providing six extra positions per board.

Figure 8. The printed circuit pattern for the MOS TAP.

Figure 9. The component layout of the basic MOS TAP.

8

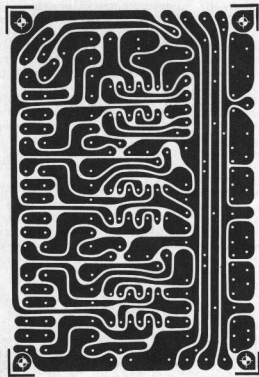

9

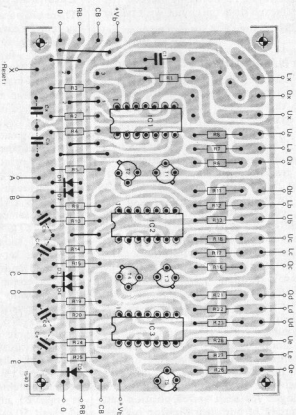

Parts list for figures 7, 9 and 10.

Resistors:

$R_1 = 2M$
 $R_2, R_4, R_9, R_{14}, R_{19}, R_{24} = 1M$
 $R_3, R_5, R_{10}, R_{15}, R_{20}, R_{25} = 10M$
 $R_6, R_8, R_{11}, R_{13}, R_{16}, R_{18}, R_{21}, R_{23}, R_{26},$
 $R_7, R_{12}, R_{17}, R_{22}, R_{27} = 220\Omega^*$

Capacitors:

$C_1 = 470p$
 $C_2 = 47n$
 $C_a - C_e = 100p^*$

Semiconductors:

$IC_1, IC_2, IC_3 = CD4011AE$ or $CD4011AD$
 (RCA)
 $T_1 - T_5 = BC109b$ or $BC109c$
 $D_1 - D_5 = BA127^*$ or equivalent

For the extension board C_1 and R_1 are not required.

The following additional parts are needed.

$R_a, R_c = 27k^*$
 $R_b = 220\Omega^*$
 $D_x = BA127$
 $T_x = BC109b$ or $BC109c$

* See text.

Figure 10. The extension board component layout. Note the differences between this board and figure 9.

Photo 1. The completed five-position MOS TAP.

pins 2 and 3 of the board, and the link which replaces C_1 .

The printed circuit board

The board for the basic MOS TAP is given in figure 8 and the associated component layout in figure 9. The board layout for extending the system is shown in figure 10. The component differences to the left of IC_1 can be clearly seen. It can be seen that the supply tracks + V_b , 0 V, and the reset lines RB and CB are available on both edges of the board, so that extending the system is simply a matter of linking across. The capacitors $C_a - C_e$ and C_x are included to improve the transient noise immunity, but they may not be required in every case. If it is desired that the switch should set in a particular position on switching on the supply than all these capacitors should be omitted, except the one connected to that switch position.

Note that diodes $D_1 - D_5$ and D_x must have very low reverse leakage, less than 200 nA., so DUS cannot be used in this circuit. If these diodes are omitted then the CB rail has no effect. In that case any number of switch positions may be on simultaneously and they can only be reset by touching the reset input connected directly to the reset monostable.

Power Supplies

The MOS TAP will operate from any supply between 3 and 15 V. The current consumption is very low, less than 10 μA . at 15 V. but of course any output current the circuit must supply is added to this.

Precautions

As mentioned earlier COSMOS IC's must

be treated with extreme care, and in particular the use of an IC socket is recommended. If the device is soldered directly into the circuit use an earthed soldering iron.

Touch contacts

The design of the touch contacts is up to the user, but should be such that they cannot be accidentally bridged by dirt, moisture etc. When a supply of less than 10 V. is used it is generally possible to employ single-point touch contacts (no earth return) as the circuit will operate from hum picked up by the body capacitance rather than from the skin resistance. Screened leads should be used in both cases if the input lead length exceeds 5 cm. and the screening should be connected to supply common (0 V.) at one end only.

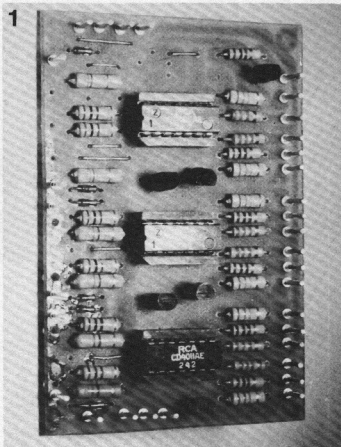
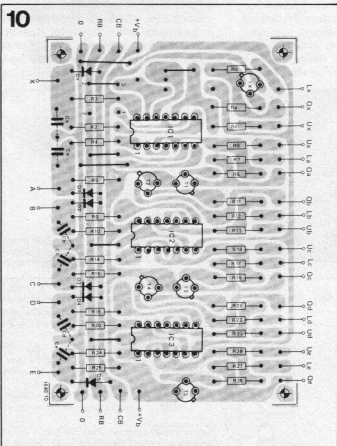

modulation systems

The recent energy crises have underlined the need to forge ahead with the development of new communication systems, not only to alleviate the ever-increasing wave-band congestion, but also to make more economical use of transmitter power.

It is hoped that this article will give an insight into the various modulation systems now in use and will also explain the design philosophy of a new transceiver developed by Elektor.

Communication systems

The purpose of a communication system is to convey information from one location to another (distant) location. The block diagram of a communication system is given in figure 1. It comprises three parts:

- an encoder to convert the information into a form suitable for transmission via the medium.
- the medium.
- a decoder to convert the information back into its original form.

One of the oldest communication systems utilises the human voice. Information from the brain is encoded into mechanical vibrations by the vocal system, transmitted via the air and reconverted by the aural system of the listener into information in the brain.

This system, although still widely used, has its drawbacks. Notably that the range is limited by the power of the lungs. The system is also subject to inter-

ference from nagging wives, mothers-in-law etc. and prone to breakdowns due to laryngitis and other complaints.

As another example of a communication system consider the postal system. Information from the brain is encoded in the form of writing, transmitted via the postal system (the medium), and decoded by the optical system of the recipient.

These two examples both require direct human intervention in the transmission and reception of the information, but this is not always necessary. Two computers, connected by a data link could carry on a meaningful dialogue without human interference or an unmanned meteorological station might transmit data to a remote terminal. Communication systems may therefore be divided into at least two categories:

- systems in which information perceptible to human sense organs is transmitted and in which the ultimate

receiver is a human sense organ which decodes the information in conjunction with the brain. Radio broadcasting and television fall into this category.

- systems in which human senses play no part in the decoding process.

The difference between the two stems from the fact that human senses can operate very selectively so that the desired information can be extracted in the presence of large amounts of unwanted information (noise & c.). This faculty may be further improved by training, so that a radio operator can frequently distinguish signals that would be unintelligible to the layman.

It is thus possible to subdivide the first category into two sub-groups:

- systems in which the impairment of the transmitted information must be as small as possible, for instance high-fidelity f.m. broadcasting and television.

1

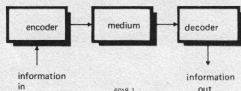

3

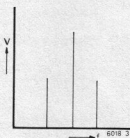

2

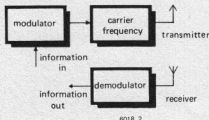

4

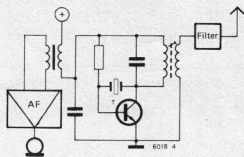

— systems whose functional capability is little impaired by distortion of the information content or even by omission of a large part of it.

Systems such as the telephone, which in general convey only speech, fall into this category. Speech is still intelligible even after removal of a large amount of the information by restricting the bandwidth or by other means.

The concept of Modulation

When electromagnetic radiation serves as a medium for the transmission (i.e. as a carrier) it is necessary to impress the information onto the carrier by changing one or more of its parameters (i.e. to modulate it). The decoder at the receiving and reconverts these changes into information.

If the discussion is confined to analogue modulation there are two important types:

- amplitude modulation (AM)
- frequency modulation (FM)

In amplitude modulation the variable parameter representing the information is the amplitude of the carrier, whereas for frequency modulation the variable is the frequency of the carrier.

The more important forms of amplitude modulation are as follows:

- double sideband with carrier (DSB)
- double sideband suppressed carrier (DSSC)
- single sideband suppressed carrier (SSB)
- carrier position modulation (CPM)

DSB

In a DSB system a low-frequency signal is used to change the amplitude of a radio-frequency carrier. In the absence of modulation the carrier continues to be radiated at a certain level. At maximum modulation the minimum value of the carrier amplitude can assume is

nil, which occurs on the 'troughs' of the modulating waveform. It therefore follows that if the modulation is linear the maximum amplitude is twice the amplitude of the unmodulated carrier on the peaks of the modulating waveform. A DSB signal is shown in photo 1. The mathematical expression for this form of modulation with a sinusoidal modulating signal is as follows:

$$v = [1 + m \cdot \cos(\omega_{AF}t)] \cdot v_0 \cos(\omega_{RF}t) \quad (1)$$

where m is the modulation index
 $v_0 \cos(\omega_{RF}t)$ is the carrier, of which v_0 is the peak unmodulated value
 $\cos(\omega_{AF}t)$ is the modulating signal.

The modulation index can have values between zero (no modulation) and unity (maximum modulation). The depth of modulation is frequently expressed as a percentage in which case 100% corresponds to a modulation index of 1. In commercial broadcast transmitters the depth of modulation is around 30%, which occurs when the AF signal reaches its maximum value, that is $\cos(\omega_{AF}t) = 1$. The mean value must therefore necessarily be lower.

Multiplying out equation (1) gives:

$$v = v_0 \cdot \cos(\omega_{RF}t) + \frac{mv_0}{2} \cdot [\cos(\omega_{RF} + \omega_{AF})t + \cos(\omega_{RF} - \omega_{AF})t] \quad (2)$$

From this equation it can be seen that the low-frequency information appears in two sidebands, placed symmetrically above and below the carrier frequency. Figure 3 shows the frequency spectrum of a DSB signal. Of course with a complex modulating waveform the sidebands

are not single frequencies but a spectrum of frequencies occupying a bandwidth equal to \pm the highest modulating frequency on each side of the carrier. It can be seen from the equation that even with a modulation index of 1, half the energy radiated is at the carrier frequency and contains no information. In fact commercial broadcast transmitters operate with a mean modulation depth considerably less than 100%. It is therefore apparent that transmitter power amounting to many gigawatts is being radiated uselessly into space by transmitters around the world. Apart from the waste of energy other undesirable phenomena occur, such as cross-modulation in the ionosphere (the Luxembourg effect). Furthermore, the system is inefficient in its use of bandwidth since it uses two sidebands each containing the complete LF information. One of these is clearly redundant.

It seems legitimate to ask why, in the face of all these objections, DSB is the most common system in use at the present time. There are two reasons. Firstly it has the stamp of antiquity. DSB is the oldest modulation system in use and consequently much capital is invested in transmission and receiving equipment. Secondly, it is the simplest system to implement, whereas more economical systems (in terms of power and bandwidth) are considerably less economical in terms of equipment cost, though viewed in the long term not unduly so. The circuit of a simple modulator is shown in figure 4. The supply potential of the transistor oscillator, and hence its output, is varied by the output of the modulation amplifier.

Demodulation, or detection, of a DSB signal is simply accomplished by means of a diode and a low-pass RC filter. The diode rectifies the modulated waveform so that only the negative half-cycles appear at its cathode. This output contains one-half of the original envelope, that is the original modulating signal. The carrier is simply removed by the low-pass filter and only the original modulation appears at the output superimposed on a d.c. potential corresponding to the amplitude of the unmodulated carrier. To increase the useful radiated power of DSB transmissions dynamic range compression is often employed. This means that the range between the loudest and softest sounds of the modulating signal is reduced, or to put it another way, pianissimo is boosted and fortissimo reduced. This means that the variation in the modulation depth is reduced.

A simple compressor is shown in figure 6. The signal at the collector of the transistor is rectified by D_1/D_2 and the potential on the capacitor at point A is applied to the base of the transistor to provide bias. If the signal through the transistor is increased the potential at point A decreases, reducing the base bias of the transistor so that the working point is shifted to a point where the gain is less. Choice of suitable time constants in the

Figure 1. Block diagram of a communication system comprising an encoder, transmission medium and encoder.

Figure 2. When electromagnetic radiation serves as the transmission medium encoding takes place in the transmitter and decoding in the receiver.

Figure 3. The frequency spectrum of a DSB signal with single frequency sinusoidal modulation.

Figure 4. DSB signals may be generated very simply as this diagram shows.

Figure 5. Simple DSB demodulator (envelope detector) using a diode as the non-linear element.

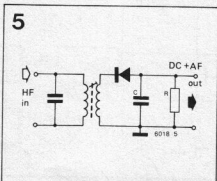
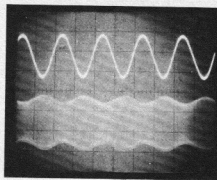

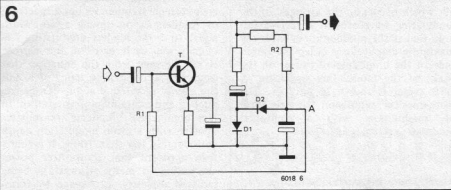

Figure 6. A dynamic compressor is simply an amplifier whose gain decreases as the input signal amplitude increases.

Figure 7. Block diagram of an AF clipper using a pair of diodes.

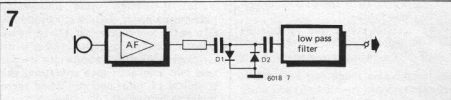

Figure 8. A symmetrical balanced modulator for the production of DSSC signals using an IC. The components in the IC are shown in the shaded portion of the diagram.

Figure 9. A simple product detector which may be used where good rejection of the input signals is not essential, or where this is done elsewhere in the circuit.

Figure 10. A 'universal' demodulator which will demodulate all existing narrow-band modulated signals both AM and FM.

Figure 11. Generation of an SSB signal by the filter method.

rectifier circuitry means that the distortion unavoidable with compressors is reduced to a minimum.

Where a communication system is to be used for speech only, intelligibility is more important than fidelity and large amounts of distortion may be tolerated. Modulation depth may then be controlled in a much more effective way by 'clipping'. In figure 7 the maximum output of the AF amplifier is limited to the forward voltage of the diodes, so any peaks in excess of this are clipped. After clipping the signal contains a lot of harmonics, so a low-pass filter is included to limit the bandwidth and thus make more economical use of waveband space.

Double Sideband Modulation with Suppressed Carrier (DSSC)

As the name suggests, with this type of modulation only the information-carrying sidebands are radiated. The waveform produced with a sinusoidal modulating signal using this type of modulation is shown in photograph 2. Suppressing the carrier obviously saves a great deal of transmitter power, but it is apparent from the photograph that the envelope of the resulting waveform is not the original modulating signal, which makes detection more difficult. Generation of DSSC signals is accomplished fairly easily by a number of circuit arrangements,

the most effective being the symmetrical balanced modulator, of which a full range is available in IC form.

The circuit of a typical balanced modulator using such an IC is given in figure 8. T_1/T_2 and T_3/T_4 form two differential pairs. The carrier is fed in through the input transformer, but in the absence of a modulating input the outputs of the two differential pairs cancel and no carrier appears at the output. T_5 and T_6 form a differential pair into which the modulating signal is fed. This causes the pairs T_1/T_2 and T_3/T_4 to deviate from the balanced condition and a signal appears at the output which is proportional to the product of the LF and RF signals.

$$\text{i.e. } V_{\text{out}} = V_1 \cdot V_2$$

Demodulation of DSSC signals is accomplished by means of a product detector whose output is the product of the two input voltages.

So that for

$$V_1 = \cos(\omega_{\text{AF}}t) \cdot \cos(\omega_{\text{RF}}t) \\ \text{(the DSSC signal)}$$

and

$$V_2 = \cos(\omega_{\text{RF}}t + \phi) \\ \text{(the regenerated carrier)}$$

the output becomes

$$V_{\text{out}} = \cos(\omega_{\text{AF}}t) \cdot \cos(\omega_{\text{RF}}t) \cdot \cos(\omega_{\text{RF}}t + \phi) \\ = \frac{1}{2} \cos(\omega_{\text{AF}}t) \cdot [\cos\phi + \cos(2\omega_{\text{RF}}t + \phi)]$$

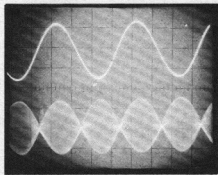
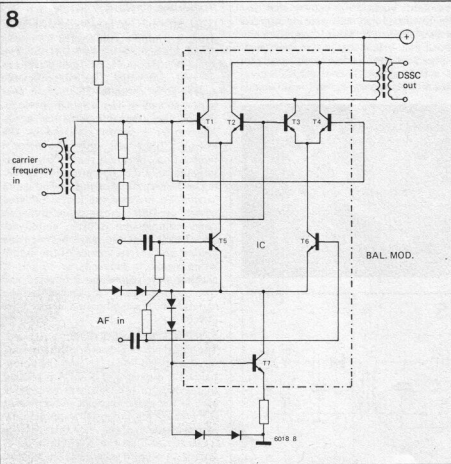

9

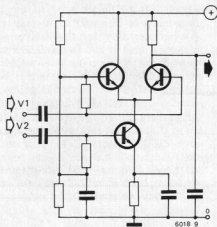

A simple low-pass filter will then remove the high-frequency component leaving the LF signal output:

$$V = \frac{1}{2} \cos(\omega_A f t) \cdot \cos \varphi \quad (3)$$

The restored carrier required for demodulation can be derived from the sidebands but the practical difficulties are considerable. For this reason a small fraction of the original carrier is radiated as a pilot frequency to facilitate regeneration of the carrier at the receiving end. In the receiver this so-called residual or vestigial carrier has its level raised to the value required for demodulation. A phase-locked loop system is used because of the stringent phase criteria which have to be met. For instance, looking at equation (3) it is apparent that if the restored carrier is shifted in phase by 90° from the original carrier the LF output will be zero. Although it is easy to achieve the correct phase with several systems, a PLL system is one of the few which will maintain a phase relationship with time and temperature changes. For the product detector the type of IC used for a balanced modulator may also be used. As the high-frequency component is quite easy to suppress at the output less complex circuits are generally used for demodulation. The more simple circuits are, however, prone to fading and RF interference.

In the Elektor laboratories a number of experiments were carried out to compare the performance of various product detector circuits and it was found that IC's

10

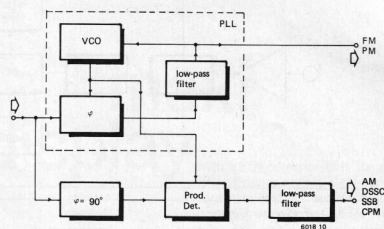

with circuitry similar to figure 9 gave the best results.

Figure 10 is the block diagram of a demodulator for DSSC signals. When a signal is tuned in the phase-locked loop regenerates the vestigial carrier. Since most practical PLL's operate with a 90° phase shift the signal is shifted by 90° before being fed to the product detector. The output of the product detector is fed to a low-pass filter which removes the high-frequency components. This system will also demodulate normal DSB signals and although it may seem a little over-engineered compared with a diode detector it does offer significant advantages, particularly in the presence of interference. Furthermore, it will become apparent that this system will demodulate SSB and CPM signals plus frequency and phase modulation. In fact it is a universal demodulator for all practical forms of analogue modulation.

Single-sideband Modulation with Suppressed Carrier (SSB)

In DSSC modulation the carrier (which contains no information) is suppressed to save transmitter power, but this makes no economies in the bandwidth required to transmit the information as compared to DSB. The transmitted signal still has two sidebands above and below the carrier frequency and since each sideband contains all the LF information one of them may be discarded with a consequent halving of the required bandwidth. This is what happens with SSB, hence

the name. For any given bandwidth twice as many SSB transmissions may be accommodated as compared with double-sideband transmissions.

There are various ways of generating an SSB signal. The simplest way is to start with a DSSC signal and to suppress one of the sidebands by filtering so that only one sideband appears at the filter output. This method offers the choice of radiating either the upper sideband (USB), or the lower sideband (LSB) depending on the choice of filter parameters.

The filter method of generating an SSB signal is shown in figure 11. Since the two sidebands are separated only by twice the lowest frequency of the modulating signal the filter must have a sharp cutoff if adequate rejection of the unwanted sideband is to be achieved. Since filter slopes are quoted in terms of dB/octave (an octave above or below a frequency is twice and half that frequency respectively) it follows that the lower the carrier frequency the further apart are the sidebands in terms of octaves, and the easier it is to filter out the unwanted sideband. For this reason the signal is often modulated onto a carrier frequency much less than the transmitter frequency and after filtering out the unwanted sideband the frequency is raised by frequency conversion to the frequency to be transmitted. Carrier suppression is also easier at low frequencies. Currently available ceramic filters can give up to 50dB rejection of the unwanted sideband.

A second method of generating SSB

11

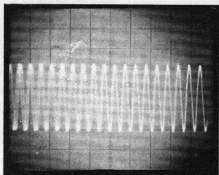
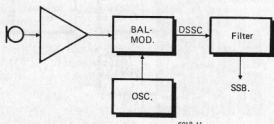

12

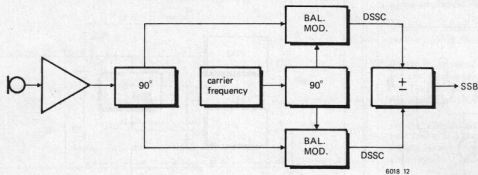

6018 12

13

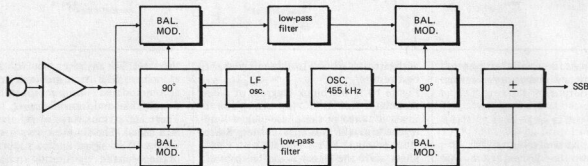

6018 13

signals is shown in figure 12, but is less common. In this arrangement the LF signal is split into two components with equal amplitude but with a 90° phase shift with respect to one another and the carrier is dealt with in a similar fashion. The LF and RF signals are then fed to two balanced modulators. The two DSSC signals so produced are displaced in phase so that if a sideband of one signal is in phase with the corresponding sideband of the other signal then the other two sidebands will be 180° out of phase. Adding the two DSSC signals will therefore cancel one sideband, and subtracting them will cancel the other, so the desired sideband may easily be selected. Since accurate wide-band phase-shifters are often difficult to realise in practice a third method of producing an SSB signal is shown in figure 13. This is a two-stage modulation procedure. The LF signal is modulated onto two sub-carriers displaced in phase by 90° . The upper sidebands are rejected

Figure 12. The phase method of producing an SSB signal avoids the use of steep-slope filters.

Figure 13. A 'double modulation' system for the generation of SSB signals. Modulation of the AF signals onto a sub-carrier avoids the use of wide-band phase shifters.

Figure 14. An RF limiter 'speech-processor' which increases the average radiated power.

Figure 15. Demodulation of an SSB signal with a beat-frequency oscillator (BFO) and product detector.

by the filters and the two signals are then processed as were the LF signals in figure 12.

Speech Processing

The envelope of an SSB signal bears no resemblance to the original modulating waveform and attempts to raise the average level of the transmitted signal by low-frequency processing such as compressors or speech clippers are doomed to failure. The most effective way of raising the average level of an SSB transmission is by limiting of the RF signal itself. This causes harmonics, widening the frequency spectrum so that the limiter must be followed by a filter to remove them. If the SSB signal is produced by the filter method then a similar filter may be used for the removal of the harmonics after clipping. Figure 14 shows the block diagram of a typical RF clipper. These devices are available commercially in various forms under the name 'Speech Processor'.

14

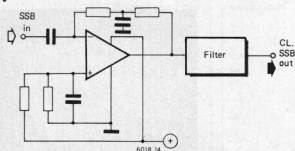

6018 14

15

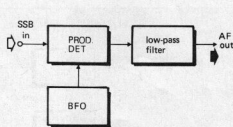

6018 15

Demodulation

An SSB signal may be demodulated with the system of figure 10, but if speech only is to be transmitted the simpler arrangement of figure 15 may be used. This system will not work satisfactorily with DSSC signals due to beat frequency problems. For example, if the regenerated carrier is not synchronised to the incoming carrier but is displaced in frequency by say 100 Hz then the sidebands will also be displaced by this amount but in opposite directions. This results in the production of a strong 200 Hz component which renders the signal quite unintelligible. With an SSB signal the only result would be to displace all the frequencies by 100 Hz and speech would probably still be intelligible, although this would be useless for music.

Interference with AF Equipment

All AM transmissions possess one common characteristic, that there is a correlation between the amplitude of the radiated signal and the amplitude of the modulating signal. Feeding such signals through an envelope detector will therefore result in an AF output, though with DSSC and SSB this will be unintelligible. In principle any non-linear element will function as an envelope detector provided the amplitude of the RF signal is sufficient. For this reason interference with domestic electronic equipment such as television and Hi-fi equipment can be a problem. Any of the semiconductor junctions in such equipment (and even dry joints, dirty plugs and the like!) could demodulate an unwanted RF signal although the most frequent cause of trouble is in the input stages of Hi-fi amplifiers. Radio amateurs are often unjustly blamed for such interference, but their equipment generally complies with the regulations and the fault is in the design of the equipment in which the interference is occurring.

Constant Amplitude Systems

Transmission systems in which the amplitude of the carrier remains constant rarely give rise to interference in domestic equipment. One possible exception is where an audio amplifier is blocked completely by a strong RF signal, but this occurrence is rare. Such systems are not necessarily more wasteful of transmitter power, since when used for speech voice-operated switches may be used so that the transmitter operates only when an LF signal is present. Another advantage of constant-amplitude systems is that automatic gain control (AGC) is much easier to include and indeed may sometimes be omitted altogether.

The second part of this article will deal with the characteristics of carrier position modulation (CPM), frequency and phase modulation. (To be continued)

maxi display

With LEDs now available for a few tens of pence each it is possible to construct a 'giant' seven-segment display from discrete LEDs for the price one would normally pay for a medium sized integrated display.

This maxi-display uses 22 LEDs per digit (3 per segment plus decimal point) and incorporates a decoder. As can be seen from the circuit diagram this display incorporates the improved 6 and 9 format described elsewhere in this issue. No current-limiting resistors are included with the LEDs since about 4.5 V of the supply voltage is dropped due to the LEDs forward voltage and their own internal resistance is sufficient to limit the current from the remaining 0.5 V to a safe value. The supply voltage must not exceed 5 V, however, when the current per segment will be about 25mA. A double-sided p.c. board is used for the construction of this display with the decoder components mounted on one side and the LEDs on the other as shown in the accompanying diagrams.

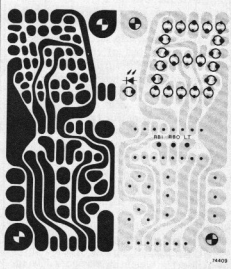
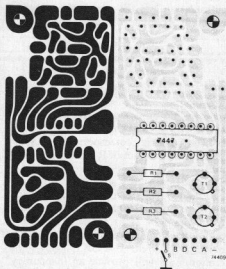
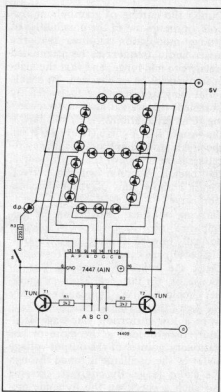

recip-riaa

invariably not sufficiently well known. This is mainly due to the work involved in accurately measuring the amplitude response (RIAA or IEC curve), overdrive margin, distortion, signal-to-noise ratio and hum level. When the reproduction quality is not quite what it should be, the blame is by established tradition laid at the door of the disc manufacturer — or if his product is demonstrably above suspicion, at those of the cartridge loudspeaker makers. The simple (and above all, electronic) preamplifier 'will surely not be misbehaving?' The weighting network described in this article greatly simplifies the above-mentioned measurements. Despite its simplicity, using only five components, it will deliver a measurement signal that is within 0.2dB of the standard RIAA cutting-curve. This should make it just about the smallest professional test instrument ever described . . .

During the cutting of gramophone records, optimum use of the possibilities of groove modulation requires that the lower audio frequencies be attenuated (relative to mid-range) and that the higher frequencies be emphasized. To enable a flat playback response to be readily obtained, this weighting is done according to an international (IEC) standard — the former RIAA-curve (figure 2). When the preamplifier amplitude-frequency response is the inverse of the cutting-curve, the overall response will be correct. Figure 1 shows this playback equalisation curve.

Carrying out measurements on the pre-amplifier now involves two specific, normally time-consuming complications. First of all, one cannot straightforwardly check the frequency response. The response of, for instance, a power amplifier should be 'flat'. This can be quickly checked by applying a constant voltage from a low distortion sine-wave oscillator, then observing the more or less stationary pointer of the output voltage meter as the oscillator is tuned through the audio range. By contrast, carrying out such a check on the dynamic pre-amplifier requires a point-by-point comparison of the meter reading with a voltage-frequency table to see if the figure 1 curve is accurately produced. (See table 1.)

This brings us to the second complication. A correct test of the nominal or maximum available output voltage as a function of frequency is only obtained when the input voltage follows the weighting curve used during cutting (figure 2). Allowing for typical levels of disc modulation and cartridge sensitivity, this measurement can be carried out using table 2 — which should cause the circuit to deliver a constant output voltage. The '0dB reference' level used in this table is 5mV at 1 KHz. The input voltages specified to achieve reference output level at other frequencies follow curve 2. The simple and direct solution to both problems should now be obvious: insert a weighting network having the amplitude-frequency response of

figure 2 between the constant-voltage oscillator and the preamplifier under test. The input voltage will now vary with frequency according to table 2, whereby the 1 KHz reference level can of course be chosen according to individual requirements. If the preamplifier is doing its job properly, it will now deliver a constant output voltage — which can easily be checked.

The weighting network

The RIAA (IEC) characteristic is defined by the time-constants $\tau_1 = 75\mu\text{s}$, $\tau_2 = 318\mu\text{s}$, $\tau_3 = 3180\mu\text{s}$. τ_2 is opposite in slope to the others. The response of the equaliser-preamplifier (curve 1) must be:

$$H_c(p) = \frac{(1 + p\tau_2)}{(1 + p\tau_1) \cdot (1 + p\tau_3)}$$

The cutting system, and therefore also the network described here, has the reciprocal transfer function:

$$H_c(p) = \frac{(1 + p\tau_1) \cdot (1 + p\tau_3)}{(1 + p\tau_2)}$$

It is not difficult to design a single network which will show response break-points corresponding to the three time constants. With the network shown in figure 3, compensation for mutual interactions requires the use of three rather different RC-time constants:

$$\begin{aligned}\tau_1 &= R_1 \cdot C_1 = 82\mu\text{s}; \\ \tau_2 &= R_1 \cdot C_2 = 240\mu\text{s}; \\ \tau_3 &= R_2 \cdot C_2 = 3000\mu\text{s}.\end{aligned}$$

The network actually also has a fourth break-point, which causes the characteristic to flatten off at a frequency well above the audio range. This frequency is near 50 KHz, corresponding roughly to the time-product of R_3 and C_1 (about 3 μs).

The time-constants specified above are chosen to give the best fit of the IEC-curve using standard component values from the E24 (5%) range. The actual component values given in figure 3 fit particularly well. Use of 1% tolerance components will provide an inaccuracy of less than 0.2dB, theoretically, while

The performance of bought or self-built preamplifiers for magnetic pickup cartridges is

Table 1. Numerical values for the IEC (RIAA) playback curve. A preamplifier supplied with a constant input level should deliver these output levels.

Table 2. Numerical values for the IEC (RIAA) cutting curve. A preamplifier supplied with these input levels should deliver a constant output level.

Table 3. Comparison of the theoretical IEC/RIAA cutting curve and the response of a prototype weighting network. The error is less than 0.1dB from 40 Hz to 16 KHz — although this particular unit was assembled from 5% components!

Figure 1. The IEC/RIAA playback equalisation curve. For CD4 and UD4 carrier-channel discs the curve flattens off at 20 KHz, due to an extra time-constant of approx. 8 μs .

Figure 2. The IEC/RIAA weighting curve used during disc-cutting. The 'recip-RIAA' network also produces this curve.

Figure 3. Circuit diagram of the network. C_2 can be made up by parallel connection of twice 1.5nF (or 2.2nF plus 820pF).

Figure 4. The measurement set-up. The weighting network (WN) is inserted between the LF generator (GEN) and the disc-preamplifier under test (DP). An AC millivoltmeter (mV) can now be used to check if the output voltage is the same for all audio frequencies.

Figure 5. Determination of drive-limits for disc cutting is a complex matter. The contours given here apply to the stylus tip velocity for the innermost grooves (diam. approx. 140mm) without use of a tracing-distortion compensator. Such devices allow far higher treble levels to be cut and are mandatory for carrier-discs.

Figure 6. The inner-groove maxima (figure 5) as they appear after equalisation (at the preamp output). The outer grooves will take +14dB from 50 Hz to 4 KHz. The preamp must have a further overload margin, particularly at higher frequencies, to allow for tracing distortion compensator cuttings.

Table 1

Frequency (Hz/KHz)	Output level (dB)	(mV)*
20 (Hz)	19.3	923
30	18.6	851
40	17.8	776
50	17.0	708
60	16.1	638
80	14.5	531
100	13.1	452
200	8.2	257
300	5.5	188
400	3.8	155
500	2.7	136
600	1.8	123
800	0.8	110
1 (KHz)	0.0	100 (ref)
2	- 2.6	74
3	- 4.7	58
4	- 6.6	47
5	- 8.2	39
6	- 9.6	33
8	-11.9	25
10	-13.7	21
16	-17.7	13
20	-19.6	10.4

* millivolt table based on 0dB = 100mV; change of reference level means that all values have to be changed by the same factor.

Table 2

Frequency (Hz/KHz)	Input level (dB)	(mV)*
20 (Hz)	-19.3	0.54
30	-18.6	0.59
40	-17.8	0.64
50	-17.0	0.71
60	-16.1	0.78
80	-14.5	0.94
100	-13.1	1.11
200	- 8.2	1.95
300	- 5.5	2.65
400	- 3.8	3.23
500	- 2.7	3.66
600	- 1.8	4.06
800	- 0.8	4.56
1 (KHz)	0.0	5.00 (ref)
2	2.6	6.7
3	4.7	8.6
4	6.6	10.7
5	8.2	12.9
6	9.6	15.1
8	11.9	19.7
10	13.7	24.2
16	17.7	38.4
20	19.6	47.7

* millivolt table based on 0dB = 5mV.

Table 3

Frequency (Hz/KHz)	IEC/ RIAA curve (dB)	proto-type (dB)	error (dB)
20 (Hz)	-19.3	-19.1	+0.2
30	-18.6	-18.4	+0.2
40	-17.8	-17.7	+0.1
50	-17.0	-17.0	0.0
60	-16.1	-16.0	+0.1
80	-14.5	-14.4	+0.1
100	-13.1	-13.0	+0.1
200	- 8.2	- 8.2	0.0
300	- 5.5	- 5.5	0.0
400	- 3.8	- 3.8	0.0
500	- 2.7	- 2.6	+0.1
600	- 1.8	- 1.8	0.0
800	- 0.8	- 0.8	0.0
1 (KHz)	0.0	0.0	0.0
2	2.6	2.6	0.0
3	4.7	4.8	+0.1
4	6.6	6.7	+0.1
5	8.2	8.2	0.0
6	9.6	9.6	0.0
8	11.9	11.8	-0.1
10	13.7	13.7	0.0
16	17.7	17.6	-0.1
20	19.6	19.4	-0.2

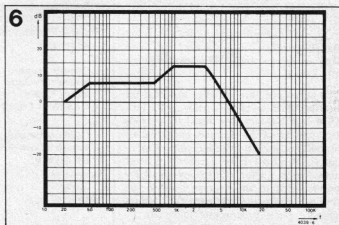
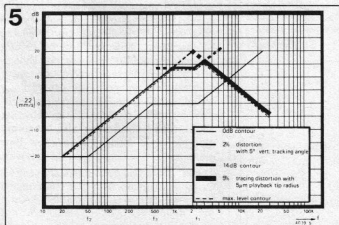
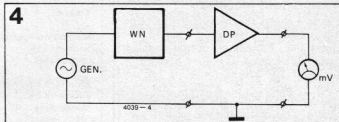
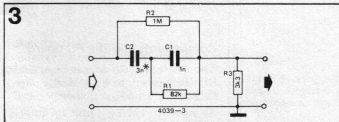
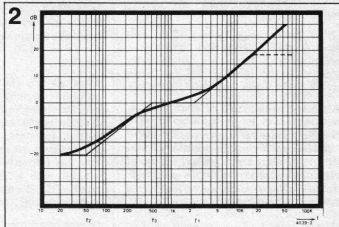
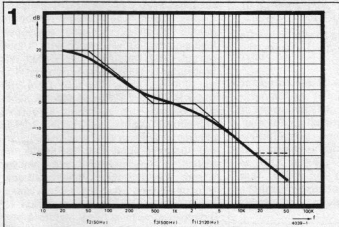

7

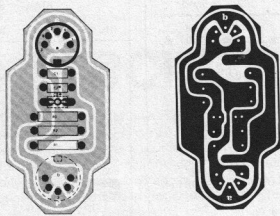

worst-case 5% components will cause maximum errors of about 1dB. High-quality components (particularly film resistors) are invariably well within their nominal tolerance — as shown in table 3 for a prototype network using 5% components. This stays within 0.1dB of the IEC curve throughout the entire audio range!

Other performance aspects of the network — such as noise and distortion — are of course orders of magnitude better than those of the best LF oscillator, which is therefore the actual limitation.

A signal-to-noise ratio of 80dB (for the network!) will be no problem at all — thermal noise is theoretically about 120dB down. From the point of view of long term accuracy, however, the use of metal-film resistors is to be preferred. Table 4 gives a summary of the overall measured performance.

Measurement procedure

Figure 4 shows the measurement set-up. The weighting network is inserted between the LF oscillator output and the preamplifier input. It is good practice — to avoid HF breakthrough, if for no other reason — to arrange that the signal-return is inside the cable screening sheath. This means the use of multiple-core screened cable, with the screen earthed at only one (either!) end. Far too much audio wiring uses the screen as a happy-dumping-ground for returning signal currents, simply asking for (and frequently getting) HF breakthrough and hum.

The reference level of disc modulation — the '0dB level' — corresponds (for CD4 and UD4 carrier discs) to a stylus tip velocity of 22.4mm/sec (peak value) at 1 KHz. Normal lp's (and some American CD4 discs) have a reference level about 5dB higher. This level generally corresponds to the average level in the loudest passages although the instantaneous peak programme level can be considerably higher, perhaps +10dB for

carrier discs and at least +20dB for normal stereo discs. With typical cartridge sensitivities of 0.5 to 2mV (RMS value per peak cm/sec) the preamplifier will operate at a 0dB level of 1 ... 5mV.

The suggested test level is 100mV from the oscillator — giving 3.5mV from the recip-RIAA network at 1 KHz input level. A preamplifier with sufficient overdrive margin should be able to handle 3.5mV + 26dB, i.e. 2 volts from the oscillator.

After all this the actual measurement procedure is quite simple: set the oscillator to 100mV output, then sweep it over the audio range and check for 'flat' output response. Some preamplifiers are designed to roll off in response at very low frequencies — 3dB at 20 Hz is typical, with a steep fall below that point. This attenuates 'rumble' and the high-amplitude subsonic frequencies

Table 4

Maximum amplitude error with 1% components	± 0.2dB
Maximum amplitude error with 5% components	± 0.9dB
Signal-to-noise ratio	80 ... 120dB
Distortion (with film resistors)	below noise
Oscillator output voltage for routine testing (0dB = ± 3.5mV at 1 KHz)	100mV
Oscillator output voltage for overdrive test (+26dB)	2V

Figure 7. PC board and component layout for the network.

Table 4. Performance characteristics of the weighting network. Noise and distortion levels will in practice be those of the LF oscillator in use.

occurring with a warped disc. This practice is legitimate, even desirable; it should certainly not be interpreted as a fault.

Having checked the frequency response at '0dB level' one should also determine the amount of overdrive 'headroom' available. Set the oscillator to 1 KHz and 2 volts output. The preamplifier should handle this cleanly (unless it is a super-high-gain circuit used only with a low-output cartridge). Now check that this headroom is available at least from 500 to 2000 Hz, preferably also from 100 to 5 KHz. Figure 5 shows a few overload-risk contours due to various aspects of disc-cutting reality, as applied to the innermost grooves of a long-playing record. Bear in mind that the limits are higher at larger groove radii and/or 45rpm. Figure 6 shows the overall contour of figure 5 after IEC (RIAA) playback equalisation. It indicates that reduced headroom at very high and very low frequencies (the former is frequently met) need not be an objection.

Components and the PC board

The PC board is designed to enable DIN connectors to be soldered onto it directly.

As mentioned above, optimum accuracy will be guaranteed only when components of 1% tolerance are used — typically metal film resistors and polystyrene capacitors. With almost any available LF oscillator, however, use of carbon film resistors and normal ceramic capacitors will not degrade any other aspect of total performance. The simplest approach is therefore to use readily available 5% components, either selecting values with a bridge or else accepting the risk of ± 0.5dB inaccuracies. Few preamplifiers are better than this anyway. The PC board has positions which enable C₂ to be made up with two components (e.g. 2 × 1.5nF or 2.2nF + 820pF), since the 'in-between' E24 values are not always easy to obtain.

how to gyrate — and why

The gyration principle was suggested by theoreticians over 25 years ago, although it is

rarely seen in practical circuits. It can, however, be used to simulate an inductance of (say) 10,000 H with a Q of 100 in a volume of less than one cubic inch . . . !

In this article the theoretical principles of the gyrator are discussed, and some practical circuits and applications are presented.

To be able to understand and use gyrators, a certain amount of theoretical background knowledge is necessary.

The basic circuit consists of two amplifiers (figure 1), with the input of one connected to the output of the other and vice versa. Amplifier A is an inverting and amplifier B is a non-inverting type. The slope of amplifier A is

$$s_1 = -g_1 (A/V)$$

and the slope of amplifier B is

$$s_2 = g_2 (A/V).$$

This means that if amplifier A is driven with an input voltage v_1 volts, it will deliver a current of $-g_1 \cdot v_1$ amps; in other words, it will sink a current of $g_1 \cdot v_1$ (A). Referring now to figure 1 it is clear that the voltages and currents are defined by the formulae:

$$i_2 = g_1 \cdot v_1$$

(amplifier A; the current into this amplifier is defined as positive, so that the minus sign disappears); and

$$i_1 = g_2 \cdot v_2$$

(amplifier B).

In these formulae g_1 and g_2 are so-called gyration-constants. They are very often equal ($g_1 = g_2 = g$); sometimes the phrase "gyration resistance" is used, defined by

$$R = \frac{1}{g}.$$

In figure 2 the recognised symbol for a gyrator is shown.

The next step is to connect an impedance (Z_1) across one set of terminals (dotted in figure 2). In this case the ratio of v_1 to i_1 is determined:

$$v_1 = i_1 \cdot Z_1.$$

From the gyrator formulae it is obvious that the voltage and current at the other set of terminals are defined by:

$$i_2 = g_1 \cdot v_1,$$

and

$$v_2 = \frac{i_1}{g_2}.$$

This means that the impedance "seen" across this second set of terminals is:

$$Z_2 = \frac{v_2}{i_2} = \frac{i_1/g_2}{g_1 \cdot v_1} = \frac{1}{g_1 \cdot g_2 \cdot Z_1}. \quad (1)$$

What a gyrator does

The most important application in prac-

tice is the simulation of inductors, for use in LC resonant circuits and the like. If the impedance Z_1 in figure 2 is a pure capacitance:

$$Z_1 = \frac{1}{j\omega C},$$

then the previous formula shows that the virtual impedance across the other set of terminals (Z_2) equals:

$$Z_2 = \frac{1}{\frac{1}{j\omega C} \cdot g_1 \cdot g_2} = j\omega \frac{C}{g_1 \cdot g_2}. \quad (2)$$

In words: if a capacitance is connected to one set of terminals, the other pair of terminals behave as if an inductance were connected between them with a value in Henries equal to the capacitance in farads divided by the product of the gyration constants. The gyration constants themselves are equal to the slopes of the two amplifiers, which leads to the interesting conclusion that a lower value for the slope leads to a higher value for the simulated inductance!

It is apparent that an LC (parallel) resonant circuit can be simulated with the circuit shown in figure 3a. In this circuit the resistors R_1 and R_2 each represent a parallel connection of the resistive components of the input impedance of one amplifier and the output impedance of the other amplifier (and the leakage resistance of the capacitor, which is usually negligible).

From the general gyrator conversion formula (1) it can be shown that this circuit is equivalent to the circuit in

Figure 1. Block diagram of the basic gyrator circuit, consisting of a non-inverting and an inverting amplifier.

Figure 2. The recognised symbol for a gyrator; the function is to "gyrate" an impedance Z_1 across one pair of terminals to a different (virtual) impedance (Z_2) across the other pair of terminals.

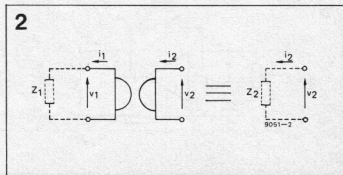
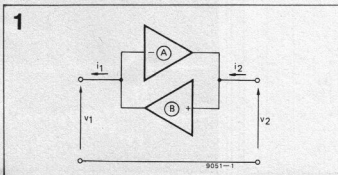

figure 3b. This, in turn, is equivalent to the circuit in figure 3c provided R_1 and R_2 in the original circuit are sufficiently large compared to the impedance of C_1 and C_2 at the operating frequency. The components in figure 3c are derived from those in figure 3a as follows:

$$L_1 = \frac{C_1}{g_1 \cdot g_2};$$

$$R_p = \frac{C_1}{C_2} \cdot R_1;$$

$$R_2 = R_2;$$

$$C_2 = C_2.$$

From these values the resonant frequency (f_0) and the quality factor (Q) can be calculated:

$$f_0 = \frac{1}{2\pi\sqrt{L_1 \cdot C_2}} = \frac{1}{2\pi\sqrt{\frac{C_1 \cdot C_2}{g_1 \cdot g_2}}};$$

$$Q = 2\pi f_0 C_2 \cdot \frac{R_p \cdot R_2}{R_p + R_2} =$$

$$\frac{R_p \cdot R_2}{R_p + R_2} \cdot \sqrt{g_1 \cdot g_2 \cdot C_1}.$$

In practice one can usually substitute $g_1 = g_2 = g$, and $C_1 = C_2 = C$, so that the formulae simplify to:

$$f_0 = \frac{g}{2\pi C} \quad (3)$$

$$Q = g \cdot \frac{R_1 \cdot R_2}{R_1 + R_2} \quad (4a)$$

If furthermore $R_1 = R_2 = R$, 4a can be further simplified to:

$$Q = \frac{1}{2} g \cdot R \quad (4b)$$

Summary

When an impedance (Z_1) is connected across one set of terminals of a gyrator, a virtual impedance (Z_2) appears across the other set of terminals:

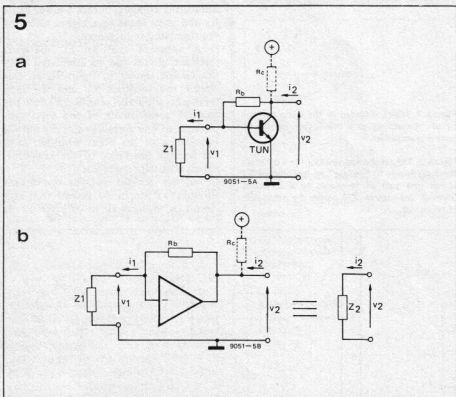
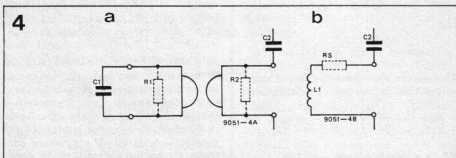
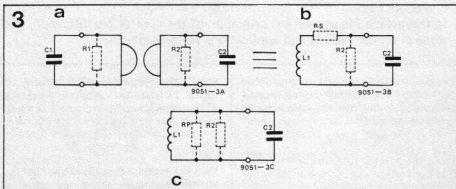

Figure 3. The most important practical application of a gyrator: simulating an LC parallel resonant circuit (figures 3B and 3C) with the aid of a gyrator and two capacitors (figure 3A).

Figure 4. In the same way a series resonant circuit (4B) can be simulated with a gyrator and two capacitors (4A).

Figure 5. The basic circuit (5A) and a block diagram (5B) of the one tun gyrator.

Figure 6. A practical application of the one tun gyrator in a smoothing circuit for the supply rail of a preamplifier. The impedance of the section inside the dotted lines is equivalent to an inductance of 250 H!

Figure 7. The circuit of the gyrator which is used in the minidrum. If a short pulse is applied to input P a decaying 30 Hz sine wave appears at the output, simulating the sound of a bassdrum.

Figure 8. An oscilloscope photo of the bassdrum in operation. The upper trace is the pulse applied to the input, and the lower trace is the output. (Scale: horizontal 50ms/div, vertical 200mV/div.)

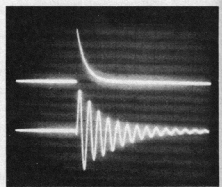

$$Z_2 = \frac{1}{g_1 \cdot g_2 \cdot Z_1} \quad (1)$$

If the impedance Z_1 is a pure capacitance (C_1), and furthermore $g_1 = g_2 = g$, the virtual impedance (Z_2) is an inductance:

$$Z_2 = j\omega \frac{C_1}{g_1 \cdot g_2} = j\omega \frac{C_1}{g^2} \quad (2)$$

which can also be written as:

$$L_2 = \frac{C_1}{g^2} \quad (2a)$$

If a second capacitor (C_2) is connected across the second set of terminals, the result is a parallel (LC) tuned circuit. If $g_1 = g_2 = g$, $C_1 = C_2 = C$ and the input and output impedances (R_1 and R_2) are equal, the resonant frequency (f_0) and quality factor (Q) are:

$$f_0 = \frac{g}{2\pi C} \quad (3)$$

$$Q = \frac{1}{2} g \cdot R \quad (4b)$$

Without further calculation it can be stated that the resonant frequency and quality factor of a series tuned circuit (figure 4) are given by the same formulae. It is obvious from the above that the input and output impedances of the amplifiers should be as high as possible to obtain a high quality factor. The slope of the amplifiers should also be high if a high quality factor is required; however this leads to a high resonant frequency unless relatively large capacitors are used. A simple calculation shows that for, say, $Q = 1000$ at $f_0 = 100$ Hz the gyration constant (or slope) must be $g = 2 \cdot 10^{-3}$ (if the input and output impedances in parallel are taken to be $1 \text{ M}\Omega$) and capacitors $C_1 = C_2 \approx 30 \mu\text{F}$ are needed. If these capacitors are electrolytics the equivalent leakage resistance may exceed the value assumed above ($1 \text{ M}\Omega$), so that a still higher value for g and hence for the capacitors is required, and so on... Having explained the theory of the gyration, we can now discuss some practical circuits.

One tun gyration

This particular circuit is used fairly regularly, although it is doubtful whether many people realise that it works as a gyration!

The basic circuit is shown in figure 5a, and figure 5b shows the same circuit with more theoretical symbols. It is clearly an asymmetrical gyration: the transistor is the inverting amplifier, with a gyration constant:

$$g_1 = \frac{i_2}{v_1} = S \approx 40I_C$$

The collector-to-base resistor (R_b) is the non-inverting "amplifier", with a gyration constant:

$$g_2 = \frac{i_1}{v_2} \approx \frac{1}{R_b}$$

The second approximation is based on the assumption that v_2 is far greater than v_1 , which is usually the case in practice. The impedance conversion is therefore defined in this case as:

$$Z_2 = \frac{1}{g_1 \cdot g_2 \cdot Z_1} \approx \frac{R_b}{S \cdot Z_1}$$

A practical application of this gyration is shown in figure 6. In this case the slope is approximately equal to

$$S \approx 40I_C \approx 200 \cdot 10^{-3} \text{ A/V,}$$

so that the virtual impedance of the section inside the dotted lines is approximately:

$$Z_2 \approx \frac{R_b}{S \cdot Z_1} \approx j\omega \cdot \frac{47 \cdot 10^3}{2 \cdot 10^2} \approx j\omega \cdot 250.$$

In other words, it behaves like a coil with an inductance of 250 H ! Adding the capacitor (C_2) across the output gives

a low-pass filter with a cut-off frequency of approximately 0.3 Hz . This means that it is a very useful smoothing circuit for the power supply of a preamplifier, for instance. The quality factor is very low, of course — theoretically $Q \approx 1$ in this case! — so that it is usually unsuitable for other applications.

The minidrum gyration

The gyration used in the minidrum (elsewhere in this issue) is a rather more complicated circuit; see figure 7.

The inverting amplifier in this circuit is T_9 . The collector load impedance for this transistor is a current source (T_8),

6

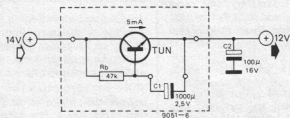

7

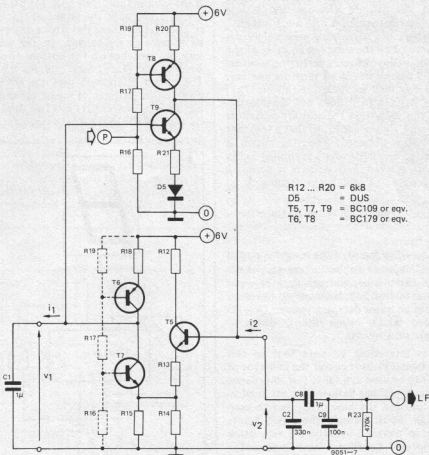

so that the gyration constant is simply:

$$g_1 = \frac{i_2}{v_1} = \frac{1}{R_{21} + r_d + r_e},$$

in which r_d and r_e are the dynamic (= AC) resistances of the diode (D_5) and the emitter of T_9 respectively. These impedances are determined by the current through T_8 and T_9 , which is approximately 0.2mA, so that

$$r_e \approx r_d \approx \frac{1}{401} \approx 125\Omega,$$

and

$$g_1 \approx \frac{1}{7 \cdot 10^3} \approx 1.4 \cdot 10^{-4}.$$

The non-inverting amplifier consists of the long-tailed pair T_5/T_7 (a differential amplifier), with the current source T_6 as collector load impedance for T_7 . The gyration constant (g_2) is determined in this case by R_{13} , $r_e(T_5)$ and $r_e(T_7)$, which have approximately the same values as R_{21} , r_d and $r_e(T_9)$ in the above formulae. From this it follows that

$$g_2 \approx g_1 = g \approx 1.4 \cdot 10^{-4},$$

so that a capacitor of 220 μ F across one pair of terminals will be "gyrated" into an inductance of 10,000 H across the other set of terminals!

This particular gyrator circuit has some outstanding characteristics. In the first place it is symmetrical ($g_1 = g_2 = g$), as shown above; furthermore the DC balance is maintained over a wide range of supply voltages without any adjustment, and the current consumption is low (approximately 2mA with a 6 V supply). Finally, the performance is mainly determined by the closeness in value of the (nominally) 6k8 resistors to one another. This means that if all resistors are, say, 5% too high in value (i.e. all are 7k1) the performance does not deteriorate. In the minidrum (bassdrum) capacitors C_1 and C_2 are added, so that a resonant circuit is obtained; when the circuit is excited by a pulse which is applied to the input marked P it delivers a decaying sine-wave, of which the frequency is:

$$f_0 \approx \frac{g}{2\pi\sqrt{C_1 C_2}} \approx 32 \text{ Hz},$$

see figure 8.

The quality factor of the resonant circuit itself depends on the current gain of the transistors used, and can vary between about 60 and 200. However, in the minidrum an extra damping resistor (R_{13}) is added which brings the Q down to approximately 10.

It is interesting to note that in this particular gyrator circuit the collector of T_5 can be used as a fairly low impedance output without influencing the quality factor, and the base of T_7 can be used as an input. Because these two points are in phase, a resistor of, say, 100k connected between them will cause the circuit to oscillate. In effect this is an LC oscillator, of which the frequency is determined by C_1 and C_2 .

improved 7 segment display

As discussed elsewhere in this issue, it is possible to distinctly improve the readability of 7-segment numeric displays by adding an extra stroke at the top of a six and at the bottom of a nine.

The other circuit uses two transistors to achieve this; however, in digital circuits one often has a few gates "left over" because the integrated circuits are not fully used. In this case it is more attractive to use these extra gates to achieve the improved readability.

The circuit in figure 1 uses two open-collector NAND gates (e.g. SN7401). The output of N_1 switches "low" when the B and C inputs are "high", i.e. for a 6 and for a 7, and adds the stroke at the top of the 6. The 7 uses this stroke anyway, so it remains unchanged. In the same way N_2 switches on the bottom stroke when A and D are "high", i.e. for the 9. The circuit in figure 2 uses one NAND gate (either normal or open collector, e.g. SN7400 or SN7401) and two diodes. As soon as the lower stroke (segment d)

is turned on, the stroke at the top (segment a) is added via D_1 . This is the case for a 2, 3, 5, 6, and 8, all of which except the 6 had this stroke anyway. The result is that only the display for the 6 is changed; the stroke at the top is added. When input D is "high", i.e. for 8 and 9, N_1 switches on the top and bottom segments through D_1 and D_2 . This gives the extra stroke at the bottom of the nine.

Figure 1. Improved readability of the 6 and 9, achieved with two open collector NAND gates.

Figure 2. The same improvement can be obtained with two diodes and one NAND gate.

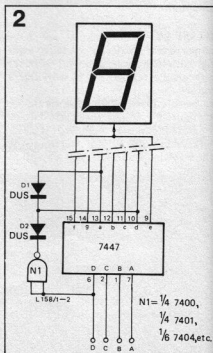
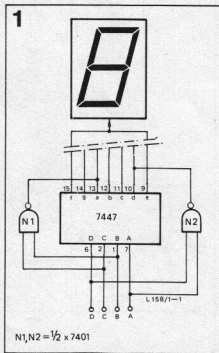

psychedelic lights

A favourite gimmick in discotheques is to use flashing lights, which are usually synchronised to

the music. An interesting addition is the psychedelic lamp driver, which livens things up a bit by flashing one or more lamps in a continuously changing rhythm.

The electrical wiring in, say, a dance hall is usually such that operating the light switch turns on the room lighting to full brightness. This situation remains unchanged until the switch is operated a second time.

The consensus of opinion is that something ought to be done about this rather dreary state of affairs. The first idea that comes to mind is to arrange for the room lighting (or some additional 'spots') to switch on and off by itself, without requiring a human operator. However a simple regular on-off rhythm quickly becomes rather boring, so we looked for ways and means to vary the flashing rate.

One of the several ways of doing this is to modulate the flashing rate - determined by a multivibrator - according to a sine wave function. Another possibility is to modulate the rate with a sawtooth function. Instead of a rhythmic deviation about some central frequency the flash rate now rises steadily from some starting value and then, when the sawtooth reaches its peak, suddenly drops back to the starting value. It would of course be possible, by inverting the modulating signal, to provide a steady slow-down instead of acceleration. It turns out that the non-inverted sawtooth provides an attractive effect, so that this is what was chosen.

The circuit

The basis of this circuit is formed by a simple uni-junction oscillator and a voltage-controlled astable multivibrator. The sawtooth waveform produced by the circuit around UJT T_1 is not particularly linear - but it doesn't need to be in this application.

What happens is that capacitor C_1 is charged via R_3 until the voltage is reached at which T_1 's emitter fires. The ensuing breakdown enables C_1 to discharge rapidly through T_1 's junction and the current-limiter R_2 . The voltage across C_1 therefore approximates a sawtooth wave. The linearity could be improved (for possible other applications) by replacing R_3 with a current-source. The charging current is then held at a constant level, without the inverted-exponential decay.

The periodic time of the voltage across C_1 is about 7 seconds. The sawtooth waveform voltage is applied, via emitter follower T_2 , to the base resistors of the astable multivibrator formed by T_3 and T_4 . As the applied voltage level increases, the multivibrator's repetition frequency will rise, vice versa.

The multivibrator output is taken from the collector of T_4 and applied via resistor R_9 to the base of T_5 . This transistor therefore switches between cutoff and saturation,

to produce a better waveform than that at the collector of T_4 (which is 'spoilt' by C_3 's charging current flowing through R_8 when T_4 is cutoff).

Modulation of the astable multivibrator is only possible in this arrangement when its running frequency is several times the repetition frequency of the sawtooth. With the values given the sawtooth varies the flash frequency in the range 2 to 6 Hz. The sharply-switched current through T_5 is used to control a triac, which switches the three lights on and off. The triac is therefore DC-driven. This has the major advantage that the triac turns on close to the zero-crossings of the mains waveform, so that no interference-causing switching peak arises. The triac specified here requires about 50mA triggering current so that the collector resistor for T_5 , R_{11} , is selected at 220 ohms.

Since the triac can switch up to 6 Amps it is possible to flash several lamps at the same time, to a maximum of about a kilowatt, allowing for the fact that the resistance of the lamp-filaments when cold will be lower than their rated (i.e. hot) value.

If several lamps are used, it is actually a better solution to provide each with its own flasher - each unit having a different sawtooth frequency. This frequency can be altered by changing the value of R_3 . A lower value increases the frequency, since the heavier current into C_1 will charge this up faster.

The circuit is supplied via D_1 , R_{10} and D_3 directly from the raw AC mains. Observe the skull-and-crossbones symbol on the drawing - and make sure of the insulation!

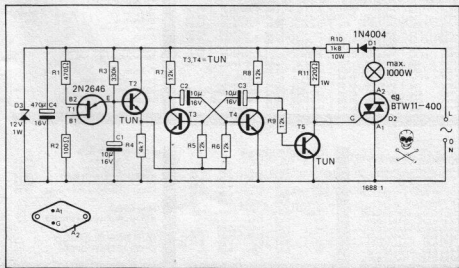

What's new in Soldering Chemicals?

Multicore's R & D Laboratories are still making news—three important new chemicals for electronics manufacturers.

MULTICORE PC 26 ROSIN FOAM FLUX

A completely new general purpose liquid soldering flux particularly suitable for the automated soldering of all types of printed circuits. PC 26 provides a unique combination of desirable properties.

- Complies with U.K. Ministry Flux Specification D.T.D. 599A.
- Eliminates "icicles" and "bridging".
- 0.5% max. halide content and yet gives better soldering than non-approved fluxes with high halide contents.
- Leaves negligible flux residues so p.c. boards are dry after soldering, can be handled and inspected easily and have better sales appeal.

MULTICORE PC 81 SOLVENT CLEANER & FLUX REMOVER

A unique blend of polar and non-polar solvents formulated for degreasing electronic hardware prior to soldering as well as for removing rosin flux residues including ionizable activators after soldering. Its intermediate boiling range of 71 to 80°C and selective solvency make it ideal for vapour degreasing.

The boiling range of PC 81 is higher than fluorinated solvents (approx 46°C) and lower than either trichloroethylene (87°C) or perchloroethylene (121°C). Also its solvency properties for rosin flux removal are superior to fluorinated solvents without in any way affecting most electronic hardware. As a result, PC 81 solvent will perform its vapour cleaning function longer and more effectively than fluorinated solvents whose vapour condensation ceases at 46°C with a consequent end to flux removal.

Solvent evaporation rate is substantially lower than that of the fluorinated solvents, making it more economical to use in open tanks and vapour degreasers.

Multicore PC 81 is a highly stabilized solvent blend, extremely resistant to thermal or chemical breakdown during prolonged heating or as a result of the introduction of activators from the solution of rosin during its working life. Its relatively narrow boiling range and high stability make it readily useable again without property changes after distillation.

PC 81 can also be used for cold cleaning and to reinforce ultrasonic cleaning. Even though its toxicity is relatively low, well ventilated areas are required.

PC 81 is expected to be particularly welcome as it is non-flammable and non-combustible under the new British "Highly Inflammable Liquid" Regulations.

Supplied in one gallon metal cans and 45 gallon steel drums.

Specific Gravity (20°C) — 1.256
Boiling Range — 71–80°C
Toxicity (TLV) — 340 ppm
Residue on Evaporation — less than 10 ppm

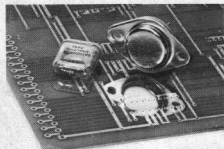
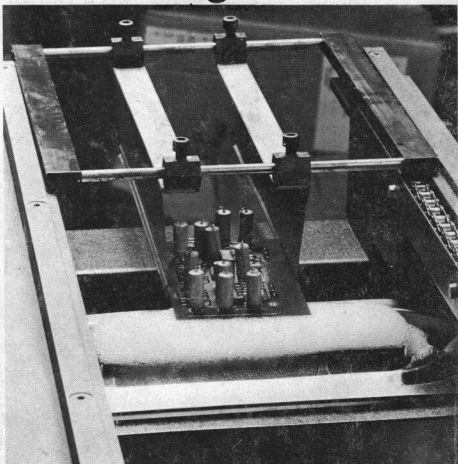

MULTICORE PC 54 CONFORMAL COATING

Fully meets the requirements of the new U.K. Defence Standard 59-47/issue 2 and U.S. Spec. MIL-1-46058C, which are becoming mandatory for the protection of many electronics assemblies against adverse environment, contamination and attack by chemicals.

PC 54 is a two-part epoxy resin system which is conveniently mixed in equal parts by volume. It may be applied by dip, spray or brush to either one or both sides of p.c. boards and components where it forms a thin tough coating after curing. PC 54 will dry in 1 hour under normal ambient conditions and develop its full properties after several days at room temperature or it may be cured in 2 to 4 hours at 65°C. A glass fibre brush can be used to remove the coating locally to enable rework and repair.



Other Multicore Soldering Chemicals include a complete range of liquid fluxes and the following special chemicals.

PC 2 Multicore Tarnish Remover
Cleans tarnish from metal surfaces prior to soldering.

PC 10A Activated Surface Preservative
Applied after pre-cleaning, preserves solderability and need not be removed.

PC 10D
A special version of PC 10A for application by roller coating machines.

PC 90 Peeloff Solder Resist and PC 91 Thinners
A temporary solder resist for edge-connector contact areas etc. Replaces masking tape.

PC 41 and PC 43
Solder Bath dross inhibitors.

PC 52 Protective Coating
One-part conformal coating. Can be soldered through.

PC 70 Thinners
Compatible Solvent blend for use with all rosin fluxes, PC 10A and PC 52.

Please write for Technical Bulletins on your Company's letterhead for products which interest you to:



MULTICORE SOLDERS LIMITED
Hemel Hempstead, Herts. HP2 7EP
Tel: Hemel Hempstead 3636 Telex 82363